

40

DC Fan Series x40x20mm

UL us CE RoHS

Optional Features



GENERAL SPECIFICATIONS

Bearing Type: Sleeve Bearing & Ball Bearing
 Material: Impeller & Frame: Plastic (UL94V-0)
 Lead Wire: UL Type
 Operation Temperature: -10°C-70°C, 35%-85%RH
 Storage Temperature: -40°C-80°C, 35%-85%RH



SPECIFICATIONS

Model	Bearing System		Rated Voltage	Operation Voltage	Rated Current	Rated Speed	Air Flow	Air Pressure	Noise Level	Weight
	Ball	Sleeve	VDC	VDC	A	RPM	CFM	mmH ₂ O	dBA	g
SD4020H5X	●	●	5.0	4.5-5.5	0.30	8000	8.8	7.5	33	25
SD4020M5X	●	●			0.24	6500	7.0	5.1	27	
SD4020L5X	●	●			0.20	5000	5.5	3.5	23	
SD4020H1X	●	●	12.0	6.0-13.8	0.15	8000	8.8	7.5	33	
SD4020M1X	●	●			0.12	6500	7.0	5.1	27	
SD4020L1X	●	●			0.07	5000	5.5	3.5	23	
SD4020H2X	●	●	24.0	12.0-27.6	0.10	8000	8.8	7.5	33	
SD4020M2X	●	●			0.07	6500	7.0	5.1	27	
SD4020L2X	●	●			0.05	5000	5.5	3.5	23	

DIMENSIONS DRAWING

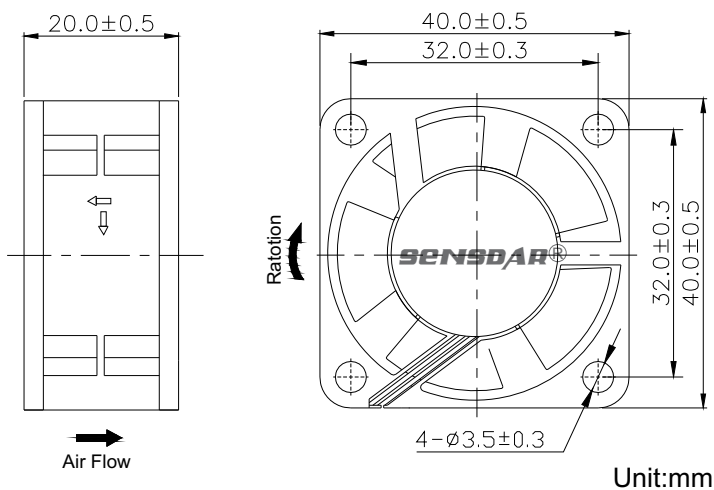

P&Q CURVE (AT RATED VOLTAGE)

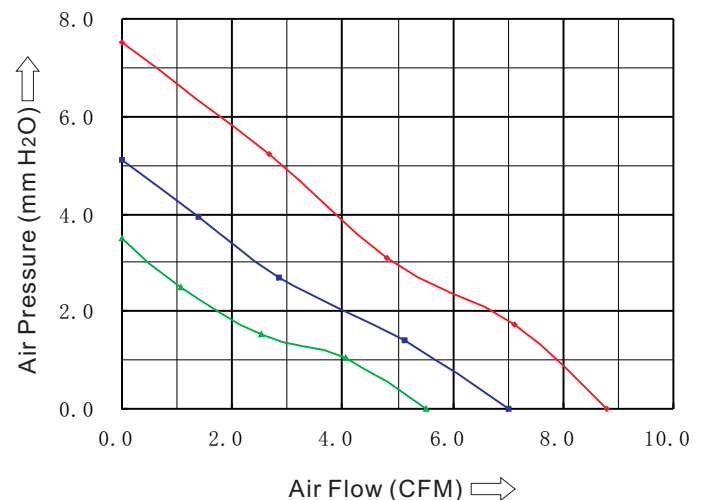

Note:

- *All readings are typical values at rated voltage.
- *Specifications are subject to change without prior notice.
- *"X" in model list can be B, S, and C, meaning Dual Ball Bearing, Sleeve Bearing and 1 Ball 1 Sleeve Bearing