

# AMMP-6232

## 18 to 32 GHz GaAs High Linearity LNA in SMT Package

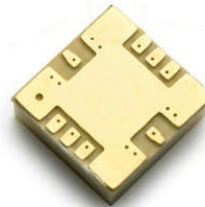

### Data Sheet



#### Description

Avago's AMMP-6232 is an easy-to-use broadband, high gain, high linearity Low Noise Amplifier in a surface mount package. The wide band and unconditionally stable performance makes this MMIC ideal as a primary or sub-sequential low noise block or a transmitter driver. The MMIC has 4 gain stages and requires a 4V, 138mA power supply for optimal performance. Since this MMIC covers several bands, it can reduce part inventory and increase volume purchase options. The MMIC is fabricated using PHEMT technology. The surface mount package eliminates the need of "chip & wire" assembly for lower cost. This MMIC is fully SMT compatible with backside grounding and I/Os.

#### Package Diagram

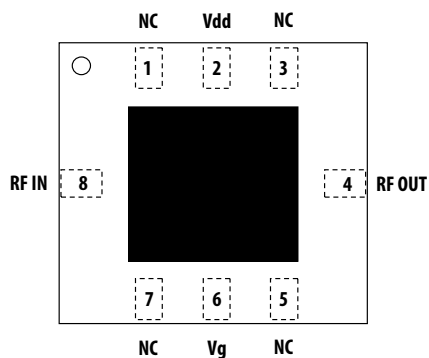

Note:

1. This MMIC uses depletion mode pHEMT devices.
2. Negative voltage is used for the gate bias

#### Features

- Surface Mount Package, 5.0 x 5.0 x 1.25 mm
- Unconditionally Stable
- 50Ω Input and Output Match

#### Specifications (Vdd = 4.0V, Idd = 138mA)

- RF Frequencies: 18 - 32 GHz
- High Output IP3: 29dBm
- High Small-Signal Gain: 23dB
- Typical Noise Figure: 3dB

#### Applications

- Microwave Radio systems
- Satellite VSAT, DBS Up/Down Link
- LMDS & Pt-Pt mmW Long Haul
- Broadband Wireless Access (including 802.16 and 802.20 WiMax)
- WLL and MMDS loops

#### Functional Block Diagram

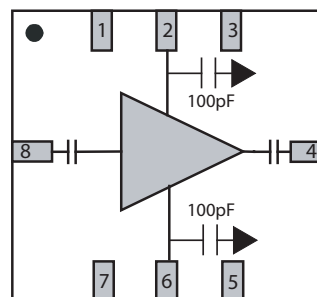

Pin	Function
1	
2	Vdd
3	
4	RFout
5	
6	Vg
7	
8	RFin

Top view

Package base: GND



**Attention: Observe precautions for handling electrostatic sensitive devices.**

ESD Machine Model (Class A) = 60V  
 ESD Human Body Model (Class 1A) = 250V  
 Refer to Avago Application Note A004R:  
 Electrostatic Discharge, Damage and Control.

Note: MSL Rating = Level 2A

## Electrical Specifications

1. Small/Large -signal data measured in a fully de-embedded test fixture form TA = 25°C.
2. Pre-assembly into package performance verified 100% on-wafer per AMMC-6220 published specifications.
3. This final package part performance is verified by a functional test correlated to actual performance at one or more frequencies.
4. Specifications are derived from measurements in a 50 Ω test environment. Aspects of the amplifier performance may be improved over a more narrow bandwidth by application of additional conjugate, linearity, or low noise (Γopt) matching.
5. All tested parameters guaranteed with measurement accuracy +/-1.5 dB for gain and +/-0.4dB for NF

**Table 1. RF Electrical Characteristics**

TA=25°C, Vdd=4.0V, Idd=135mA, Zo=50 Ω

Parameter	Min	Typ.	Max	Unit	Comment
Small Signal Gain, Gain	19	23		dB	Test Frequency = 20, 26, 29 GHz
Noise Figure into 50 Ω, NF		3	4.5	dB	Test Frequency = 20, 26, 29 GHz
Output Power at 1 dB Gain Compression, P-1dB		18		dBm	
Output Power at 3 dB Gain Compression, Psat		20		dBm	
Output Third Order Intercept Point, OIP3		29		dBm	
Isolation, Iso		-45		dB	
Input Return Loss, RLin		-10		dB	
Output Return Loss, RLout		-10		dB	

**Table 2. Recommended Operating Range**

1. Ambient operational temperature TA = 25°C unless otherwise noted.
2. Channel-to-backside Thermal Resistance (Tchannel (Tc) = 34°C) as measured using infrared microscopy. Thermal Resistance at backside temperature (Tb) = 25°C calculated from measured data.

Description	Min.	Typical	Max.	Unit	Comments
Drain Supply Current, Idd		135	150	mA	Vd = 4.5 V, Under any RF power drive and temperature
Drain Supply Voltage, Vd	3	4	5	V	
Gate Bias Current, Ig		0.1		mA	
Gate Bias Voltage, Vg	-1.1	-0.95	-0.8	V	

**Table 3. Thermal Properties**

Parameter	Test Conditions	Value
Thermal Resistance, $\theta_{jc}$	Channel-to-backside Thermal Resistance $T_{channel}(T_c)=34^{\circ}\text{C}$ Thermal Resistance at backside temperature $T_b=25^{\circ}\text{C}$	$\theta_{ch-b} = 35.1^{\circ}\text{C/W}$

**Absolute Minimum and Maximum Ratings****Table 4. Minimum and Maximum Ratings**

Description	Pin	Min.	Max.	Unit	Comments
Drain to Ground Supply Voltage	Vdd		5.5	V	
Gate-Drain Voltage	Vgd		-8	V	
Drain Current	Idd		200	mA	
Gate Bias Voltage	Vg		+0.8	V	
Gate Bias Current	Ig		1	mA	
RF CW Input Power	Pin		10	dBm	
Channel Temperature			+150	$^{\circ}\text{C}$	
Storage Temperature		-65	+150	$^{\circ}\text{C}$	
Maximum Assembly Temperature			+260	$^{\circ}\text{C}$	20 second maximum

Notes:

1. Operation in excess of any one of these conditions may result in permanent damage to this device.

## AMMP-6232 Typical Performance [1, 2]

( $T_A = 25^\circ\text{C}$ ,  $V_{dd}=4\text{V}$ ,  $I_{dd}=138\text{mA}$ ,  $Z_{in} = Z_{out} = 50 \Omega$  unless noted)

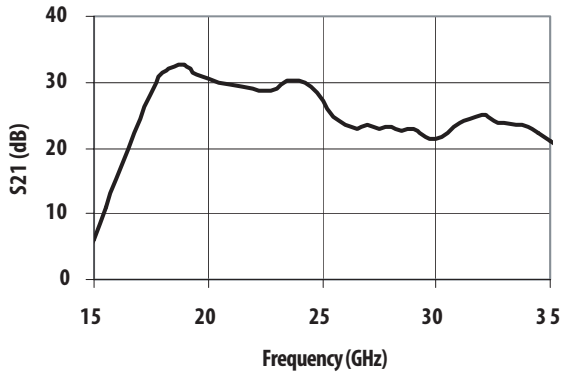

Figure 1. Small-signal Gain

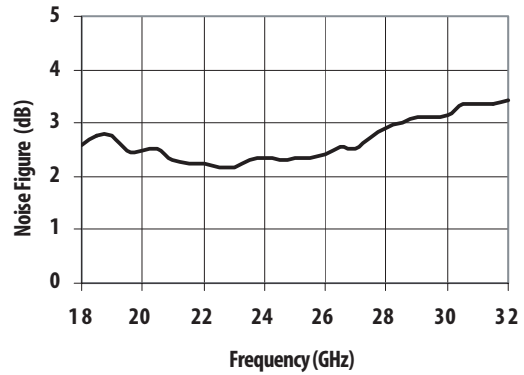

Figure 2. Noise Figure

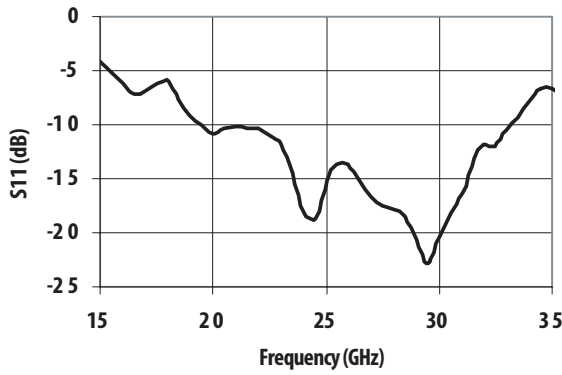

Figure 3. Input Return Loss

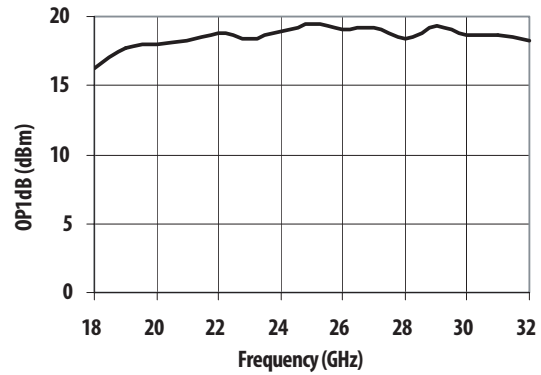

Figure 4. Output P-1dB

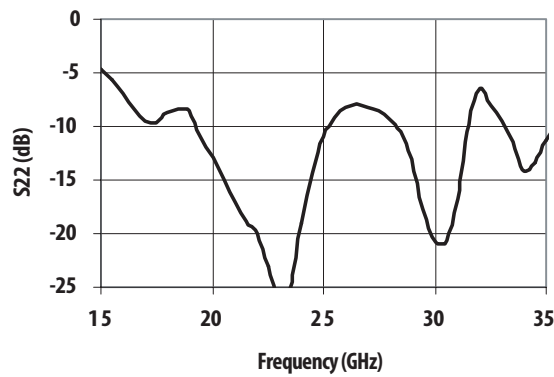

Figure 5. Output Return Loss

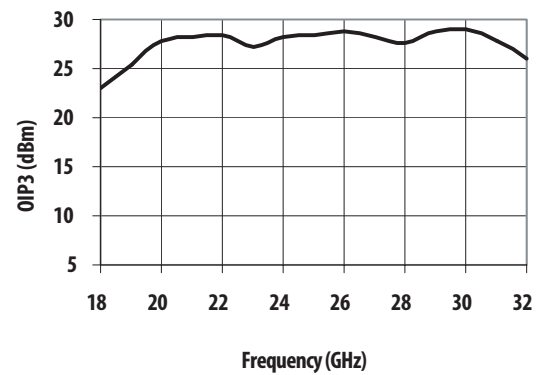

Figure 6. Output IP3

Note:

1. S-parameters are measured on R&D Eval Board as shown in Figure 20. Effects of connectors and board traces are included in results.
2. Noise Figure is measured on R&D Eval Board as shown in Figure 20, and with a 3dB pad at the input. Board and Connector losses are already de-embedded from the data.

## AMMP-6232 Typical Performance (cont.)

( $T_A = 25^\circ\text{C}$ ,  $V_{dd}=4\text{V}$ ,  $I_{dd}=138\text{mA}$ ,  $Z_{in} = Z_{out} = 50\ \Omega$  unless noted)

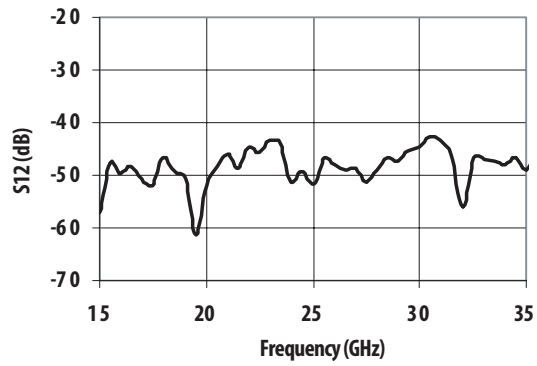

Figure 7. Isolation

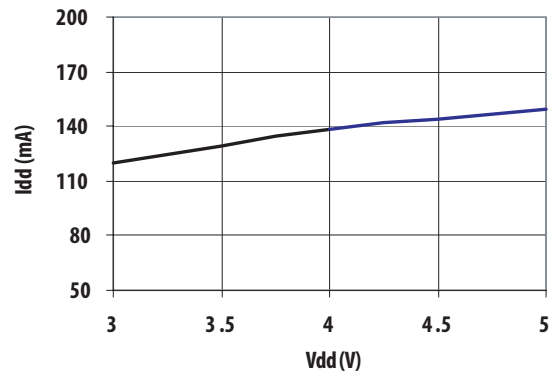

Figure 8. Total Current

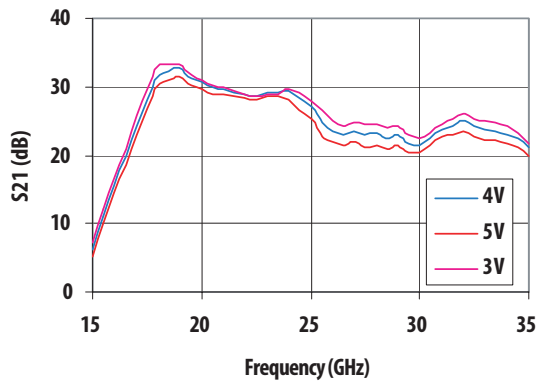

Figure 9. Gain over Vdd

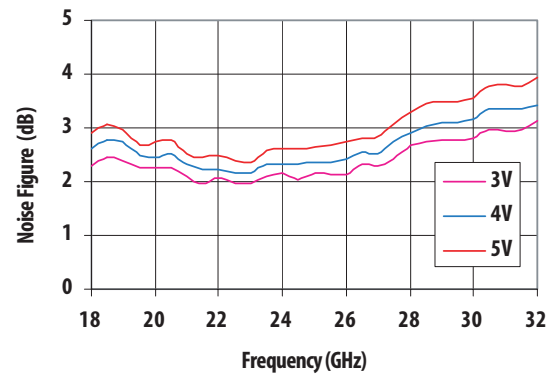

Figure 10. Noise Figure over Vdd

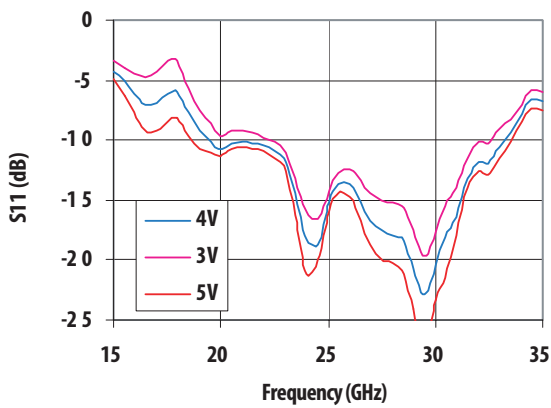

Figure 11. Input Return Loss Over Vdd

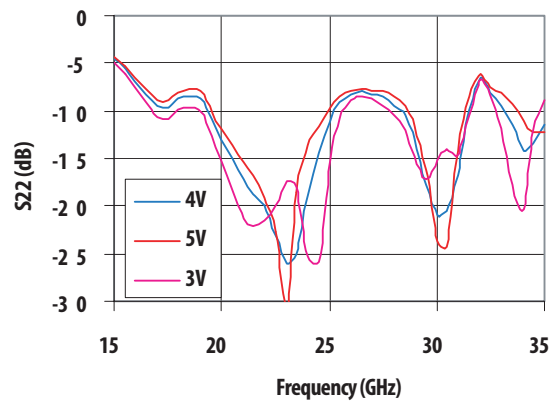

Figure 12. Output Return Loss Over Vdd

## AMMP-6232 Typical Performance (cont.)

( $T_A = 25^\circ\text{C}$ ,  $V_{dd}=4\text{V}$ ,  $I_{dd}=138\text{mA}$ ,  $Z_{in} = Z_{out} = 50 \Omega$  unless noted)

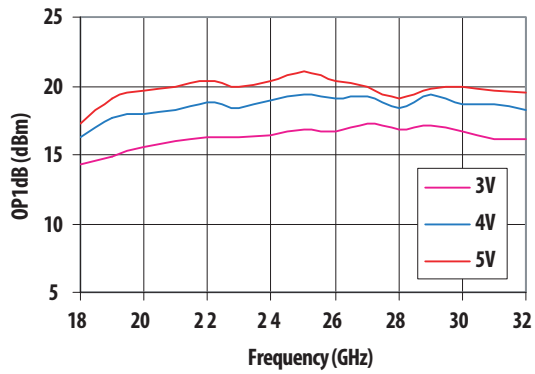

Figure 13. Output P-1dB over Vdd

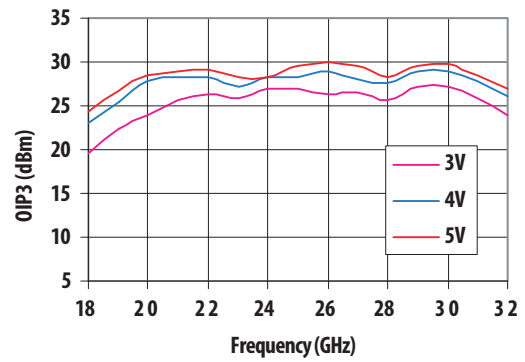

Figure 14. Output IP3 Over Vdd

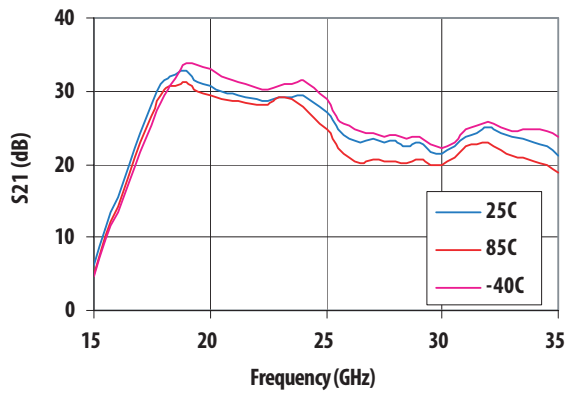

Figure 15. Gain over Temp

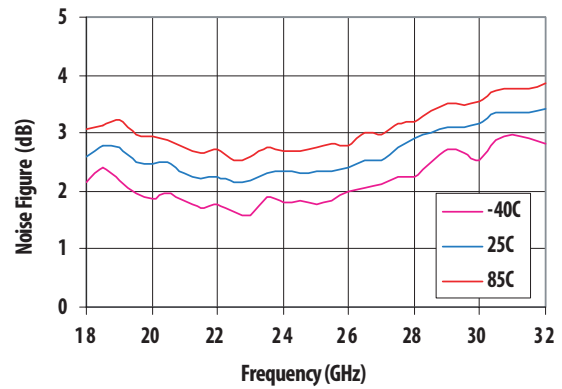

Figure 16. Noise Figure over Temp

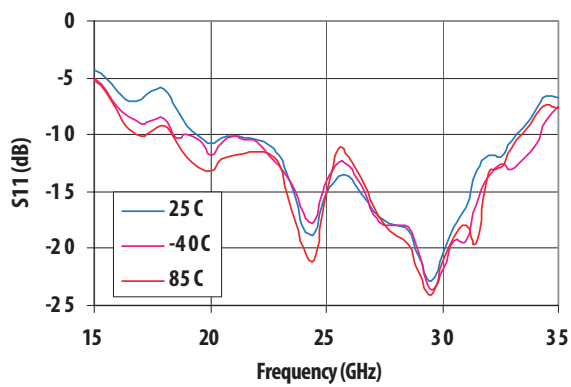

Figure 17. Input Return Loss Over Temp

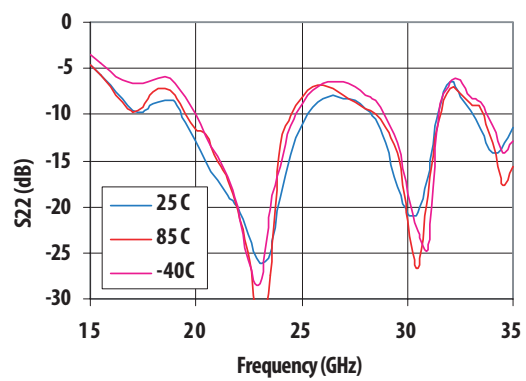
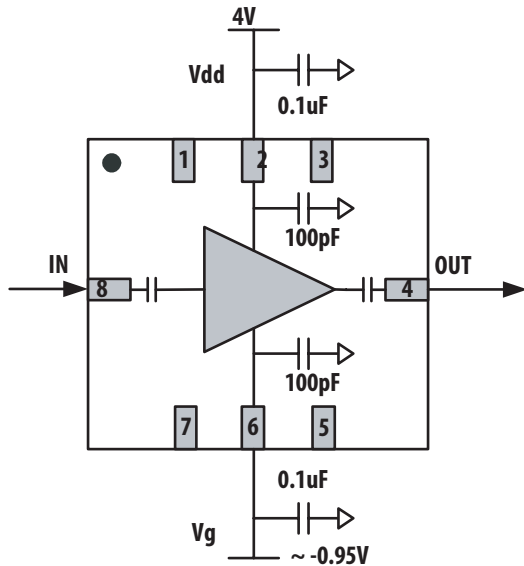

Figure 18. Output Return Loss Over Temp

## AMMP-6232 Application and Usage



Top View

Package base: GND

Figure 19. Usage of the AMMP-6232

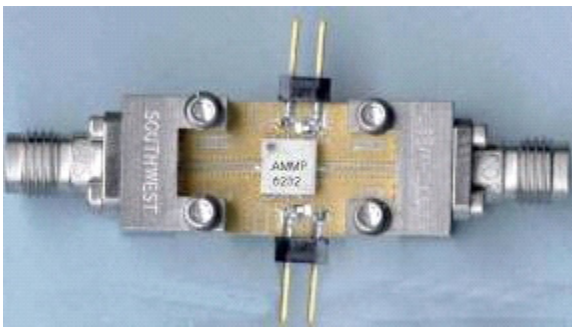

Figure 20. Evaluation/Test Board (available to qualified customer request)

## Biasing and Operation

The AMMP-6232 is normally biased with a positive drain supply connected to the VDD pin and a negative gate bias through bypass capacitors as shown in Figure 19. The recommended drain supply voltage is 4 V and the gate bias is approximately -0.95V to get the corresponding drain current of 138mA. It is important to have 0.1uF bypass capacitors and the capacitor should be placed as close to the component as possible. Aspects of the amplifier performance may be improved over a narrower bandwidth by application of additional conjugate, linearity, or low noise (Topt) matching.

After adjusting the gate bias to obtain 138mA at Vdd = 4V, the AMMP-6232 can be safely biased at 3V or 5V (while fixing the gate bias) as desired. At 4V, the performance is an optimal compromise between power consumption, gain and power/linearity. It is both applicable to be used as a low noise block or driver. At 3V, the amplifier is ideal as a front end low noise block where linearity is not highly required. At 5V, the amplifier can provide 1 to 2dBm more output power for LO or transmitter driver applications where high output power and linearity are often required.

Refer the Absolute Maximum Ratings table for allowed DC and thermal conditions.

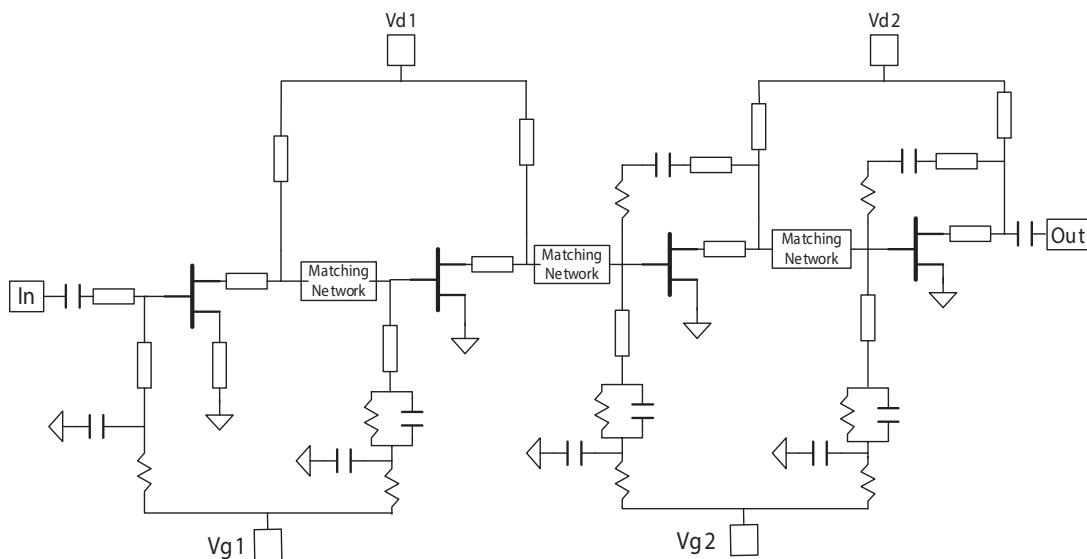

Figure 21. Simplified AMMP-6232 Schematic

## Typical Scattering Parameters

Please refer to <<http://www.avagotech.com>> for typical scattering parameters data.

## Package Dimension, PCB Layout and Tape and Reel information

Please refer to Avago Technologies Application Note 5520, AMxP-xxxx production Assembly Process (Land Pattern A).

## AMMP-6232 Part Number Ordering Information

Part Number	Devices Per Container	Container
AMMP-6232-BLKG	10	Antistatic bag
AMMP-6232-TR1G	100	7" Reel
AMMP-6232-TR2G	500	7" Reel

For product information and a complete list of distributors, please go to our web site: [www.avagotech.com](http://www.avagotech.com)

Avago, Avago Technologies, and the A logo are trademarks of Avago Technologies in the United States and other countries. Data subject to change. Copyright © 2005-2013 Avago Technologies. All rights reserved. Obsoletes AV01-0442EN AV02-0491EN - July 8, 2013





# Mouser Electronics

Authorized Distributor

Click to View Pricing, Inventory, Delivery & Lifecycle Information:

[Avago Technologies:](#)

[AMMP-6232-BLKG](#)