



**DMC2020USD**

**20V COMPLEMENTARY PAIR ENHANCEMENT MODE MOSFET**

**Product Summary**

Device	V <sub>(BR)DSS</sub>	R <sub>DS(on)</sub> max	I <sub>D</sub> Max T <sub>A</sub> = 25°C (Notes 3 & 5)
Q1	20V	20mΩ @ V <sub>GS</sub> = 4.5V	8.5A
		28mΩ @ V <sub>GS</sub> = 2.5V	7.2A
Q2	-20V	33mΩ @ V <sub>GS</sub> = -4.5V	-6.8A
		45mΩ @ V <sub>GS</sub> = -2.5V	-5.8A

**Features and Benefits**

- Reduced footprint with two discretes in a single SO8
- Low gate drive
- Low input capacitance
- Fast Switching Speed
- Low Input/Output Leakage
- **ESD Protected up to 2kV**
- **“Lead Free”, RoHS Compliant (Note 1)**
- **Halogen and Antimony Free. “Green” Device (Note 1)**

**Mechanical Data**

- Case: SO-8
- Case Material: Molded Plastic, “Green” Molding Compound. UL Flammability Classification Rating 94V-0
- Moisture Sensitivity: Level 1 per J-STD-020
- Terminals Connections: See Diagram
- Terminals: Finish - Matte Tin annealed over Copper lead frame. Solderable per MIL-STD-202, Method 208
- Weight: 0.074 grams (approximate)

**Description and Applications**

This MOSFET has been designed to minimize the on-state resistance (R<sub>DS(on)</sub>) and yet maintain superior switching performance, making it ideal for high efficiency power management applications.

- Motor control
- DC-DC Converters
- Power management functions
- Notebook Computers and Printers

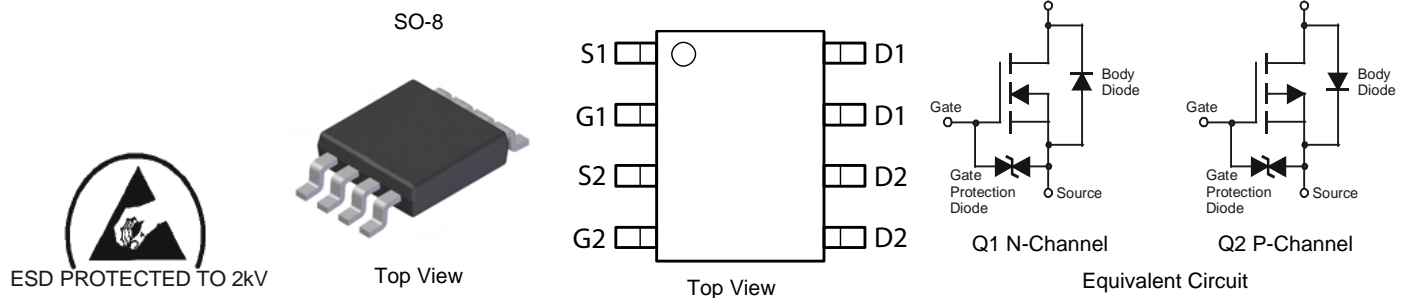

**Ordering Information** (Note 1)

Product	Marking	Reel size (inches)	Tape width (mm)	Quantity per reel
DMC2020USD-13	C2020UD	13	12	2,500

Notes: 1. No purposefully added lead. Diodes Inc.'s "Green" policy and packaging details can be found on our website at <http://www.diodes.com>.

**Marking Information**

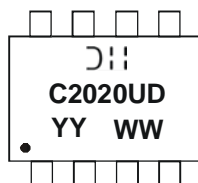

⏏ = Manufacturer's Marking  
 C2020UD = Product Type Marking Code  
 YYWW = Date Code Marking  
 YY = Year (ex: 09 = 2009)  
 WW = Week (01 - 53)

**Maximum Ratings** @ $T_A = 25^\circ\text{C}$  unless otherwise specified

Characteristic			Symbol	N-Channel - Q1	P-Channel - Q2	Units
Drain-Source Voltage			$V_{DSS}$	20	-20	V
Gate-Source Voltage			$V_{GSS}$	$\pm 10$	$\pm 10$	
Continuous Drain Current	$V_{GS} = 4.5\text{V}$	(Notes 3 & 5)	$I_D$	8.5	-6.8	A
		$T_A = 70^\circ\text{C}$ (Notes 3 & 5)		6.8	-5.4	
		(Notes 2 & 5)		6.5	-5.2	
		(Notes 2 & 6)		7.8	-6.3	
Pulsed Drain Current	$V_{GS} = 4.5\text{V}$	(Notes 4 & 5)	$I_{DM}$	33.6	-26.8	
Continuous Source Current (Body diode)			$I_S$	4.0	-4.0	
Pulsed Source Current (Body diode)			$I_{SM}$	33.6	-26.8	

**Thermal Characteristics** @ $T_A = 25^\circ\text{C}$  unless otherwise specified

Characteristic		Symbol	N-Channel - Q1	P-Channel - Q2	Unit
Power Dissipation Linear Derating Factor	(Notes 2 & 5)	$P_D$	1.25		W mW/ $^\circ\text{C}$
			10		
	(Notes 2 & 6)		1.8		
			14.3		
Thermal Resistance, Junction to Ambient	(Notes 2 & 5)	$R_{\theta JA}$	2.14		$^\circ\text{C}/\text{W}$
			17.2		
	(Notes 2 & 6)		100		
	(Notes 3 & 5)		70		
Thermal Resistance, Junction to Lead	(Notes 3 & 5)	$R_{\theta JL}$	58		
Operating and Storage Temperature Range			$T_J, T_{STG}$	-55 to +150	$^\circ\text{C}$

- Notes:
2. For a device surface mounted on 25mm x 25mm x 1.6mm FR4 PCB with high coverage of single sided 1oz copper, in still air conditions; the device is measured when operating in a steady-state condition.
  3. Same as note (2), except the device is measured at  $t \leq 10$  sec.
  4. Same as note (2), except the device is pulsed with  $D = 0.02$  and pulse width 300 $\mu\text{s}$ .
  5. For a dual device with one active die.
  6. For a device with two active die running at equal power.
  7. Thermal resistance from junction to solder-point (at the end of the drain lead).

**Thermal Characteristics**

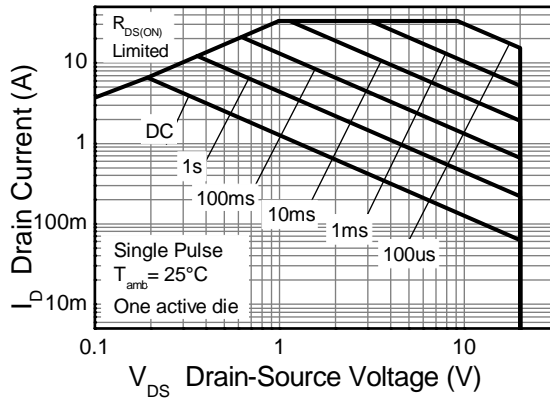

**N-channel Safe Operating Area**

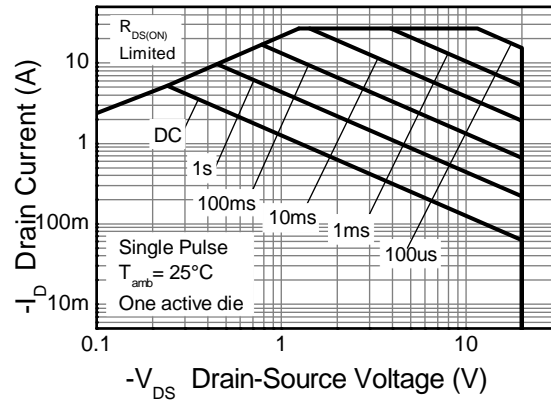

**P-channel Safe Operating Area**

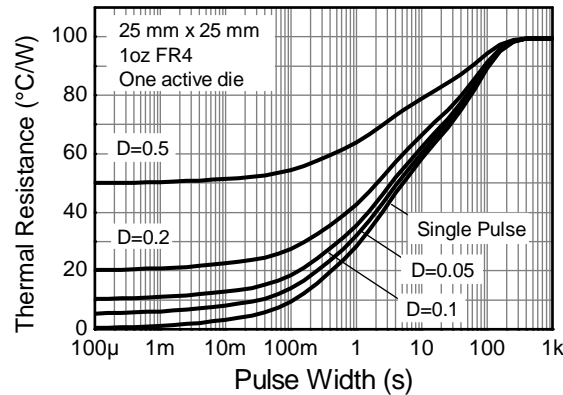

**Transient Thermal Impedance**

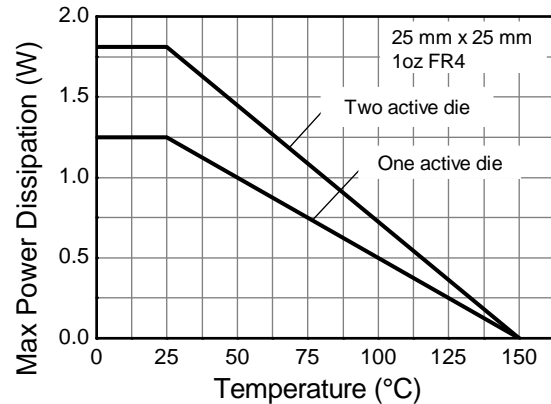

**Derating Curve**

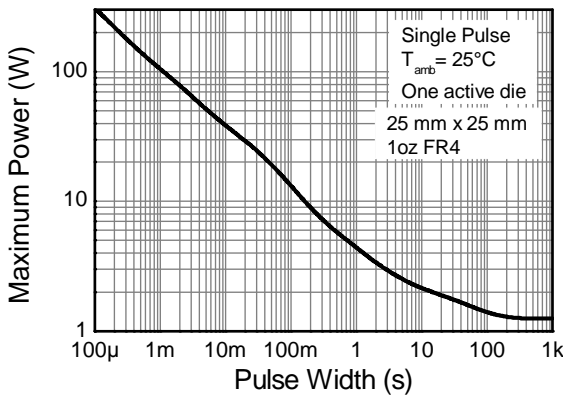

**Pulse Power Dissipation**

**Electrical Characteristics – Q1 N-CHANNEL** @T<sub>A</sub> = 25°C unless otherwise specified

Characteristic	Symbol	Min	Typ	Max	Unit	Test Condition
<b>OFF CHARACTERISTICS</b>						
Drain-Source Breakdown Voltage	BV <sub>DSS</sub>	20	-	-	V	V <sub>GS</sub> = 0V, I <sub>D</sub> = 250μA
Zero Gate Voltage Drain Current	I <sub>DSS</sub>	-	-	1.0	μA	V <sub>DS</sub> = 20V, V <sub>GS</sub> = 0V
Gate-Source Leakage	I <sub>GSS</sub>	-	-	±10	μA	V <sub>GS</sub> = ±10V, V <sub>DS</sub> = 0V
<b>ON CHARACTERISTICS</b>						
Gate Threshold Voltage	V <sub>GS(th)</sub>	0.5	1.1	1.5	V	V <sub>DS</sub> = V <sub>GS</sub> , I <sub>D</sub> = 250μA
Static Drain-Source On-Resistance (Note 8)	R <sub>DS(on)</sub>	-	13	20	mΩ	V <sub>GS</sub> = 4.5V, I <sub>D</sub> = 7A
			18	28		V <sub>GS</sub> = 2.5V, I <sub>D</sub> = 3A
Forward Transfer Admittance (Notes 8 & 9)	Y <sub>fs</sub>	-	16	-	S	V <sub>DS</sub> = 5V, I <sub>D</sub> = 9.4A
Diode Forward Voltage (Note 8)	V <sub>SD</sub>	-	0.7	1.2	V	V <sub>GS</sub> = 0V, I <sub>S</sub> = 1.3A
Continuous Source Current	I <sub>S</sub>	-	-	1.8	A	-
<b>DYNAMIC CHARACTERISTICS (Note 9)</b>						
Input Capacitance	C <sub>iss</sub>	-	1149	-	pF	V <sub>DS</sub> = 10V, V <sub>GS</sub> = 0V, f = 1.0MHz
Output Capacitance	C <sub>oss</sub>	-	157	-		
Reverse Transfer Capacitance	C <sub>rss</sub>	-	142	-		
Gate Resistance	R <sub>g</sub>	-	1.51	-	Ω	V <sub>DS</sub> = 0V, V <sub>GS</sub> = 0V, f = 1MHz
Total Gate Charge (Note 10)	Q <sub>g</sub>	-	6.0	-	nC	V <sub>DS</sub> = 10V I <sub>D</sub> = 9.4A
Total Gate Charge (Note 10)	Q <sub>g</sub>	-	11.6	-		
Gate-Source Charge (Note 10)	Q <sub>gs</sub>	-	2.7	-		
Gate-Drain Charge (Note 10)	Q <sub>gd</sub>	-	3.4	-		
Turn-On Delay Time (Note 10)	t <sub>D(on)</sub>	-	11.67	-	ns	V <sub>GS</sub> = 4.5V, V <sub>DS</sub> = 10V, R <sub>G</sub> = 6Ω, I <sub>D</sub> = 1A
Turn-On Rise Time (Note 10)	t <sub>r</sub>	-	12.49	-		
Turn-Off Delay Time (Note 10)	t <sub>D(off)</sub>	-	35.89	-		
Turn-Off Fall Time (Note 10)	t <sub>f</sub>	-	12.33	-		

Notes: 8. Measured under pulsed conditions. Pulse width ≤ 300μs; duty cycle ≤ 2%  
 9. For design aid only, not subject to production testing.  
 10. Switching characteristics are independent of operating junction temperatures.

**Typical Characteristics – Q1 N-CHANNEL**

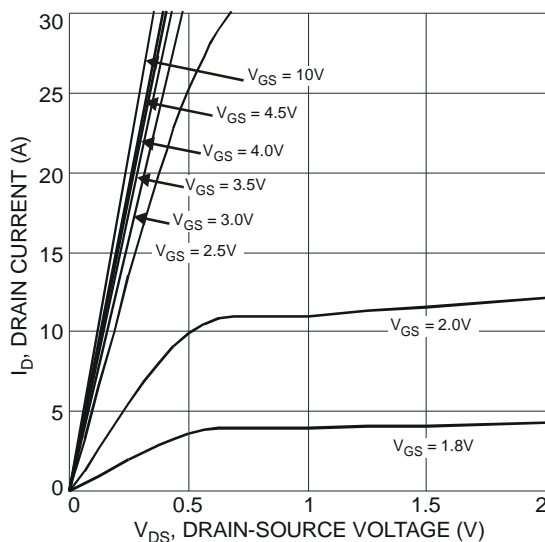

Fig. 1 Typical Output Characteristics

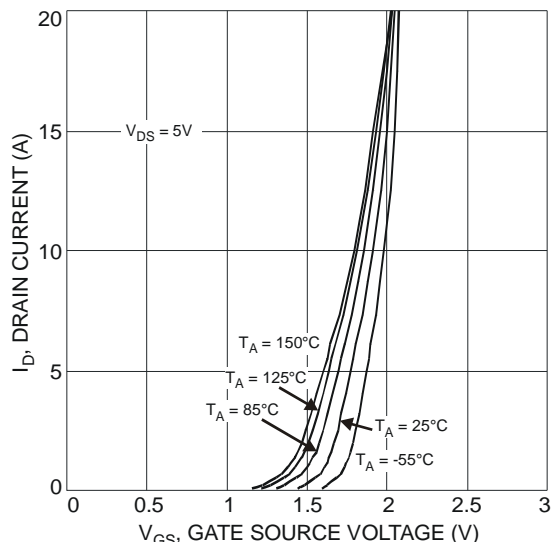
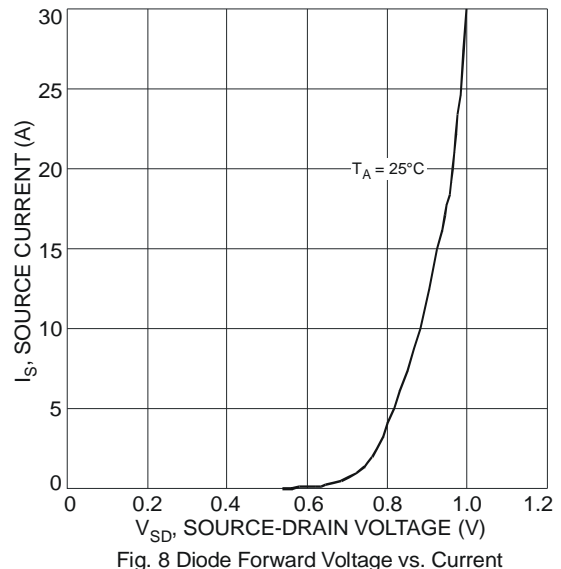
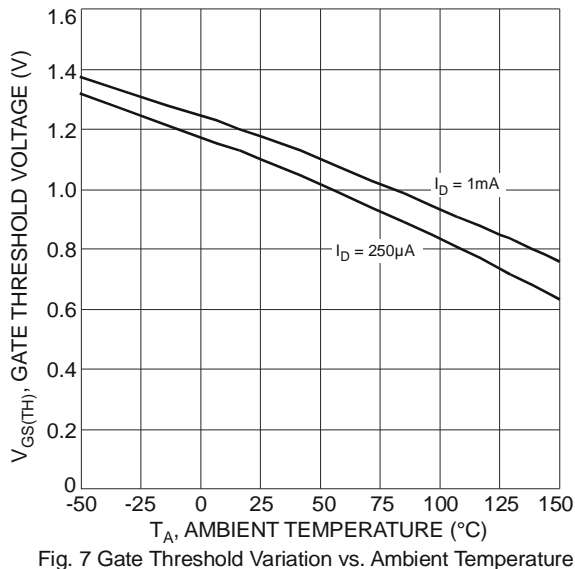
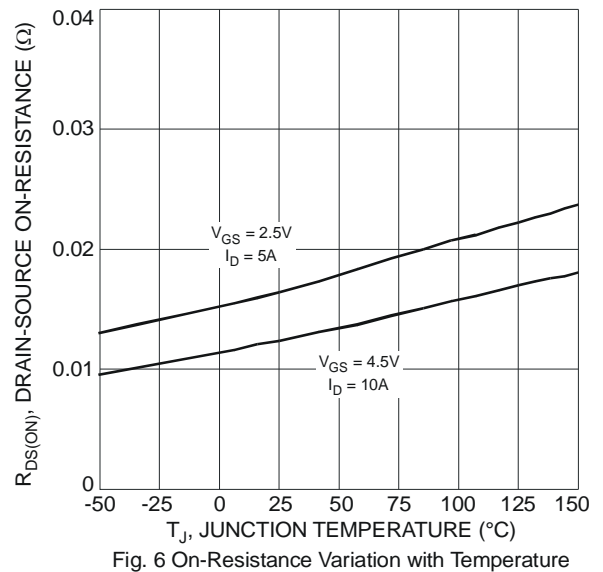
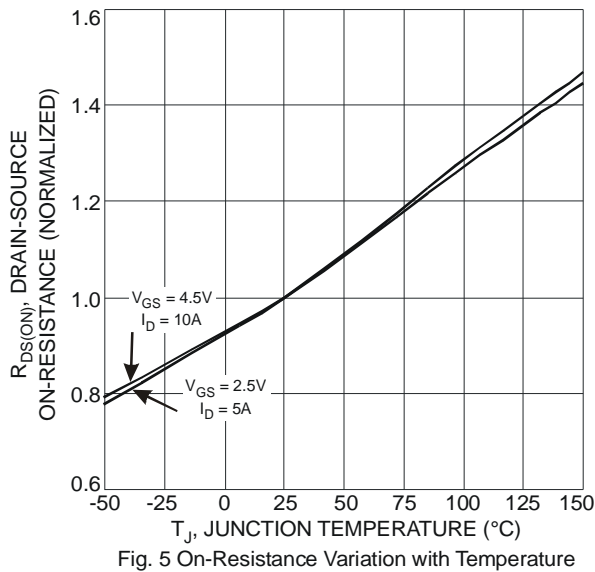
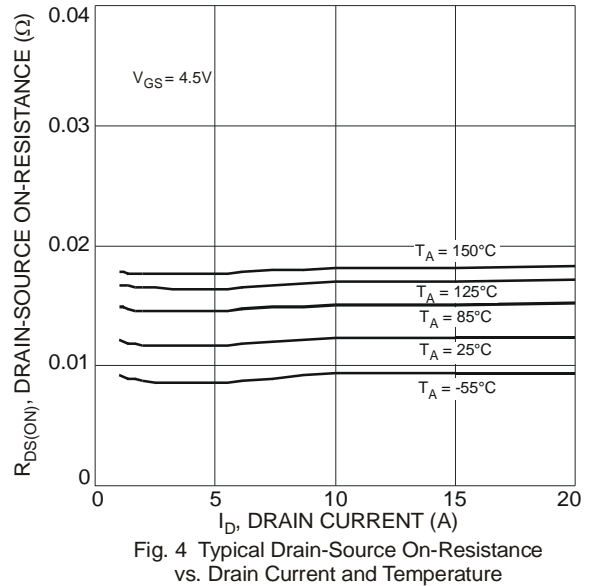
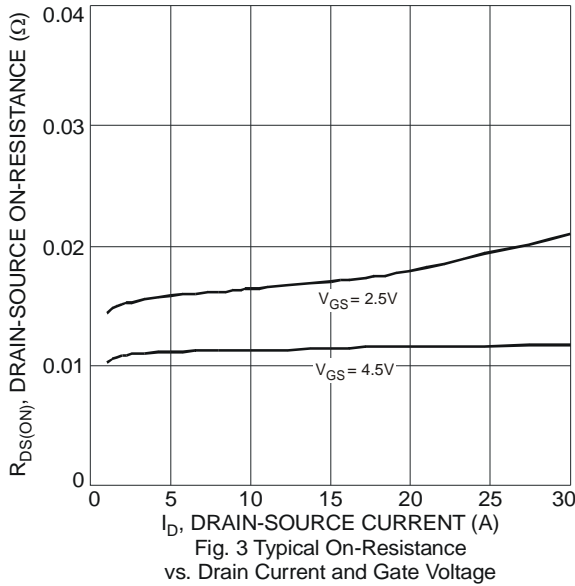
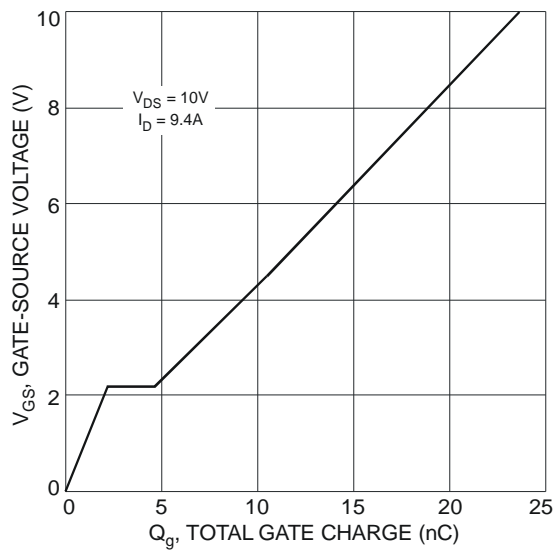
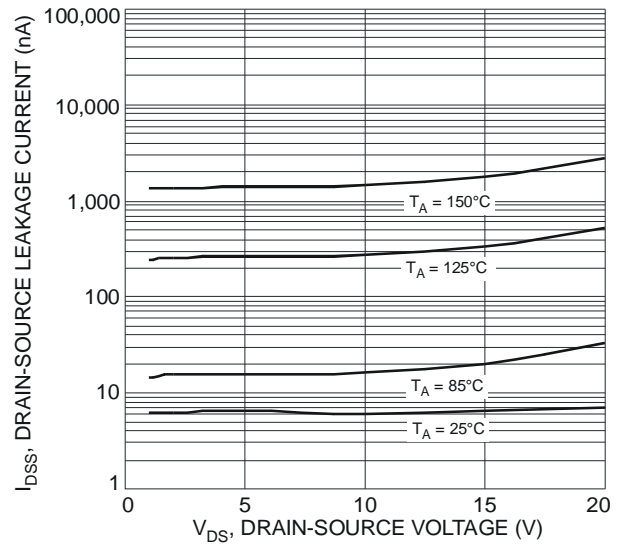
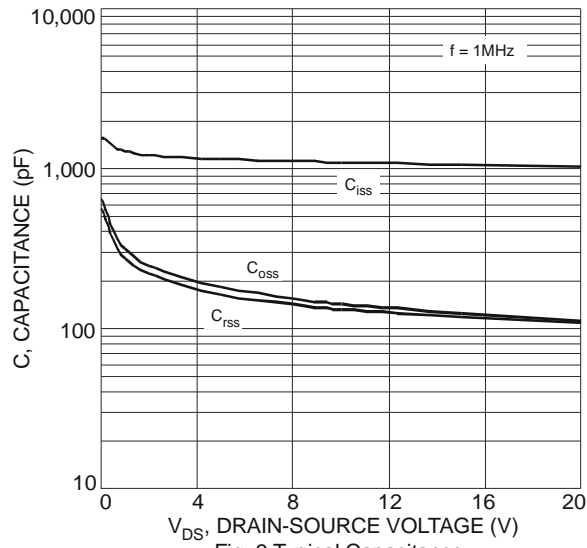

Fig. 2 Typical Transfer Characteristics

**DMC2020USD**



**DMC2020USD**



**Electrical Characteristics – Q2 P-CHANNEL** @ $T_A = 25^\circ\text{C}$  unless otherwise specified

Characteristic	Symbol	Min	Typ	Max	Unit	Test Condition
<b>OFF CHARACTERISTICS</b>						
Drain-Source Breakdown Voltage	$BV_{DSS}$	-20	-	-	V	$V_{GS} = 0V, I_D = -250\mu A$
Zero Gate Voltage Drain Current	$I_{DSS}$	-	-	-1.0	$\mu A$	$V_{DS} = -20V, V_{GS} = 0V$
Gate-Source Leakage	$I_{GSS}$	-	-	$\pm 10$	$\mu A$	$V_{GS} = \pm 8V, V_{DS} = 0V$
<b>ON CHARACTERISTICS (Note 7)</b>						
Gate Threshold Voltage	$V_{GS(th)}$	-0.4	-0.7	-1.0	V	$V_{DS} = V_{GS}, I_D = -250\mu A$
Static Drain-Source On-Resistance (Note 11)	$R_{DS(on)}$	-	26	33	m $\Omega$	$V_{GS} = -4.5V, I_D = -6A$
			33	45		$V_{GS} = -2.5V, I_D = -3A$
Forward Transfer Admittance (Note 11 & 12)	$ Y_{fs} $	-	14	-	S	$V_{DS} = -5V, I_D = -4A$
Diode Forward Voltage (Note 11)	$V_{SD}$	-	-0.7	-1.0	V	$V_{GS} = 0V, I_S = -1A$
Continuous Source Current	$I_S$	-	-	-1.8	A	-
<b>DYNAMIC CHARACTERISTICS (Note 12)</b>						
Input Capacitance	$C_{iss}$	-	1610	-	pF	$V_{DS} = -10V, V_{GS} = 0V, f = 1.0MHz$
Output Capacitance	$C_{oss}$	-	157	-		
Reverse Transfer Capacitance	$C_{rss}$	-	145	-		
Gate Resistance	$R_g$	-	9.45	-	$\Omega$	$V_{DS} = 0V, V_{GS} = 0V, f = 1MHz$
Total Gate Charge (Note 13)	$Q_g$	-	8.0	-	nC	$V_{GS} = -2.5V$ $V_{DS} = -10V$ $I_D = -4A$
Total Gate Charge (Note 13)	$Q_{g1}$	-	15.4	-		
Gate-Source Charge (Note 13)	$Q_{gs}$	-	2.5	-		
Gate-Drain Charge (Note 13)	$Q_{gd}$	-	3.3	-		
Turn-On Delay Time (Note 13)	$t_{D(on)}$	-	16.8	-	ns	$V_{GS} = -4.5V, V_{DS} = -10V, R_G = 6\Omega, I_D = -1A$
Turn-On Rise Time (Note 13)	$t_r$	-	12.4	-		
Turn-Off Delay Time (Note 13)	$t_{D(off)}$	-	94.1	-		
Turn-Off Fall Time (Note 13)	$t_f$	-	42.4	-		

Notes: 11. Measured under pulsed conditions. Pulse width  $\leq 300\mu s$ ; duty cycle  $\leq 2\%$   
 12. For design aid only, not subject to production testing.  
 13. Switching characteristics are independent of operating junction temperatures.

**Typical Characteristics – Q2 P-CHANNEL**

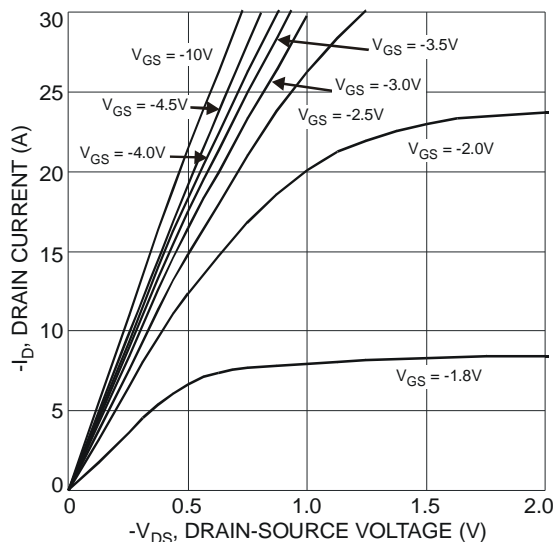

Fig. 12 Typical Output Characteristics

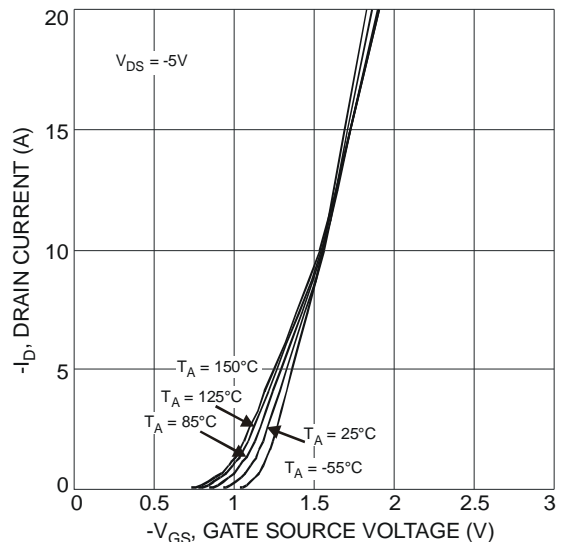

Fig. 13 Typical Transfer Characteristics

**DMC2020USD**

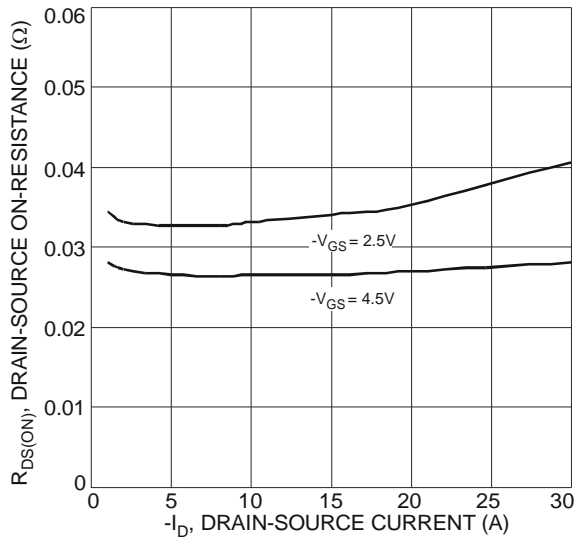

Fig. 14 Typical On-Resistance vs. Drain Current and Gate Voltage

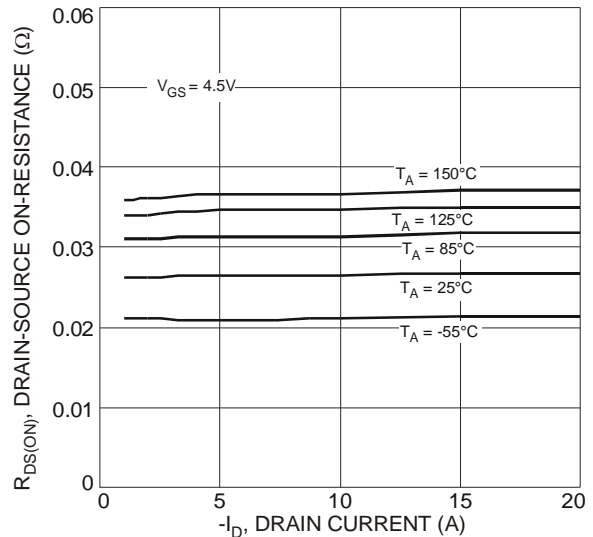

Fig. 15 Typical Drain-Source On-Resistance vs. Drain Current and Temperature

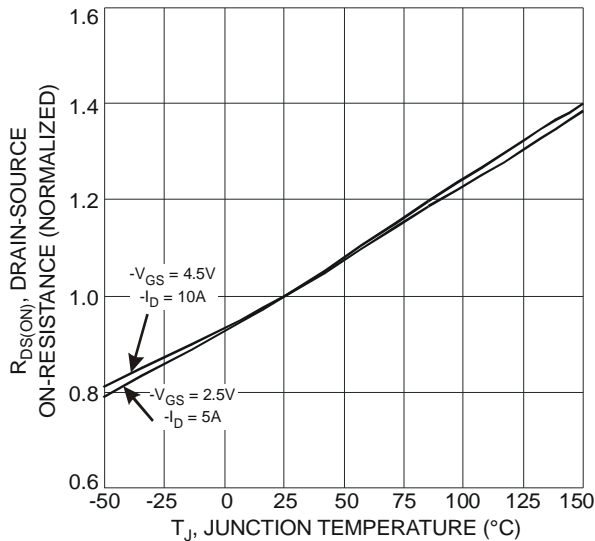

Fig. 16 On-Resistance Variation with Temperature

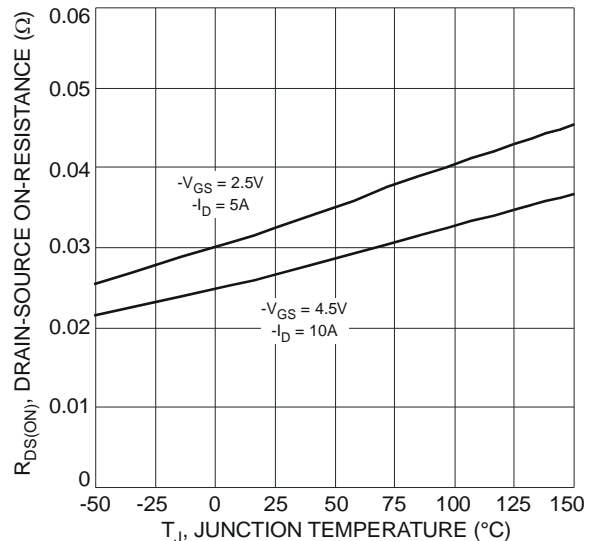

Fig. 17 On-Resistance Variation with Temperature

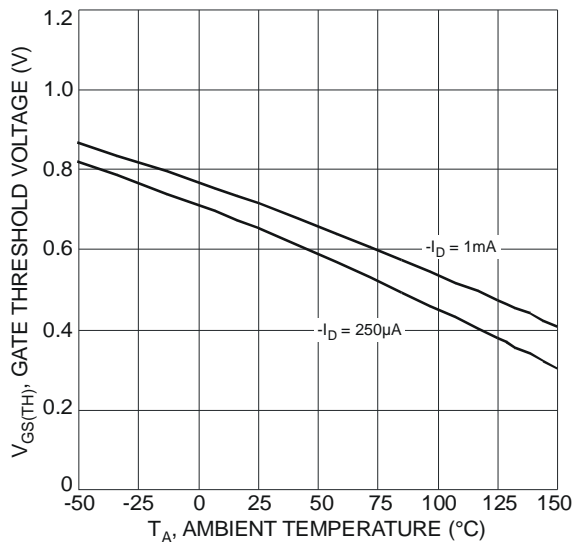

Fig. 18 Gate Threshold Variation vs. Ambient Temperature

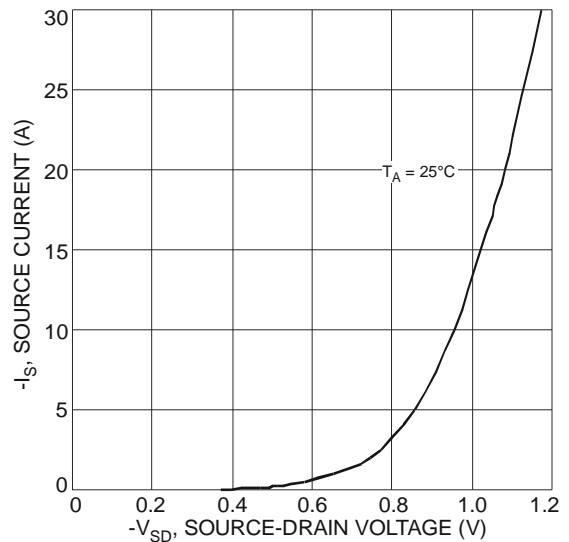
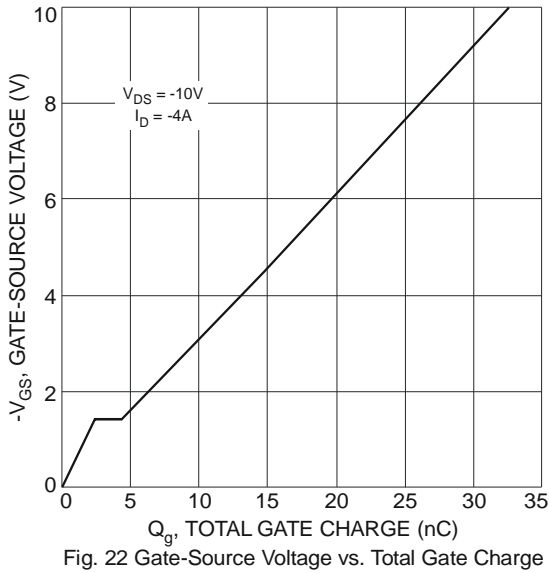
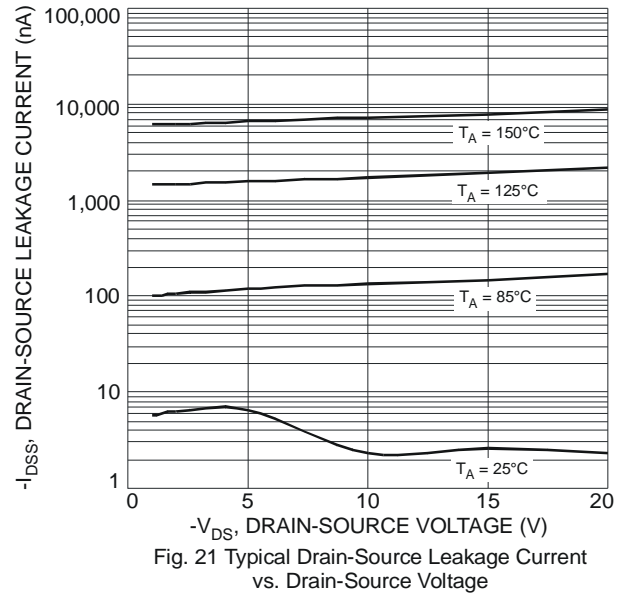
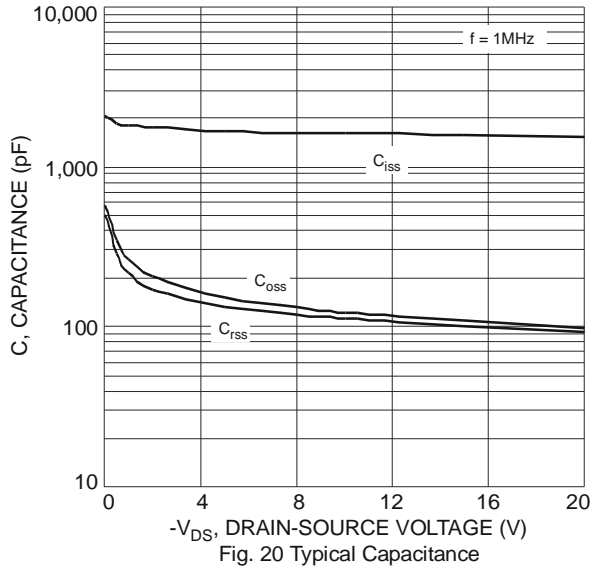
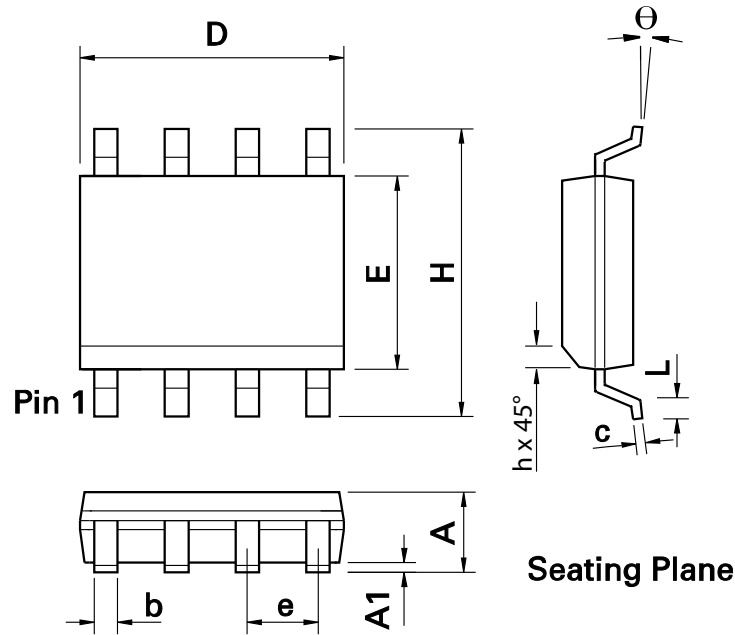

Fig. 19 Diode Forward Voltage vs. Current





**Package Outline Dimensions**



DIM	Inches		Millimeters		DIM	Inches		Millimeters	
	Min.	Max.	Min.	Max.		Min.	Max.	Min.	Max.
A	0.053	0.069	1.35	1.75	e	0.050 BSC		1.27 BSC	
A1	0.004	0.010	0.10	0.25	b	0.013	0.020	0.33	0.51
D	0.189	0.197	4.80	5.00	c	0.008	0.010	0.19	0.25
H	0.228	0.244	5.80	6.20	theta	0°	8°	0°	8°
E	0.150	0.157	3.80	4.00	h	0.010	0.020	0.25	0.50
L	0.016	0.050	0.40	1.27	-	-	-	-	-

**Suggested Pad Layout**

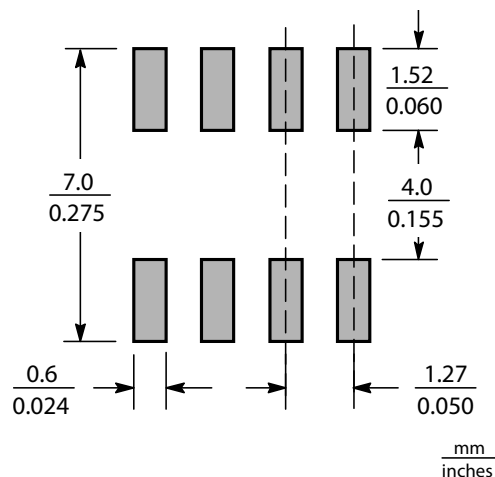

**IMPORTANT NOTICE**

DIODES INCORPORATED MAKES NO WARRANTY OF ANY KIND, EXPRESS OR IMPLIED, WITH REGARDS TO THIS DOCUMENT, INCLUDING, BUT NOT LIMITED TO, THE IMPLIED WARRANTIES OF MERCHANTABILITY AND FITNESS FOR A PARTICULAR PURPOSE (AND THEIR EQUIVALENTS UNDER THE LAWS OF ANY JURISDICTION).

Diodes Incorporated and its subsidiaries reserve the right to make modifications, enhancements, improvements, corrections or other changes without further notice to this document and any product described herein. Diodes Incorporated does not assume any liability arising out of the application or use of this document or any product described herein; neither does Diodes Incorporated convey any license under its patent or trademark rights, nor the rights of others. Any Customer or user of this document or products described herein in such applications shall assume all risks of such use and will agree to hold Diodes Incorporated and all the companies whose products are represented on Diodes Incorporated website, harmless against all damages.

Diodes Incorporated does not warrant or accept any liability whatsoever in respect of any products purchased through unauthorized sales channel. Should Customers purchase or use Diodes Incorporated products for any unintended or unauthorized application, Customers shall indemnify and hold Diodes Incorporated and its representatives harmless against all claims, damages, expenses, and attorney fees arising out of, directly or indirectly, any claim of personal injury or death associated with such unintended or unauthorized application.

Products described herein may be covered by one or more United States, international or foreign patents pending. Product names and markings noted herein may also be covered by one or more United States, international or foreign trademarks.

**LIFE SUPPORT**

Diodes Incorporated products are specifically not authorized for use as critical components in life support devices or systems without the express written approval of the Chief Executive Officer of Diodes Incorporated. As used herein:

A. Life support devices or systems are devices or systems which:

1. are intended to implant into the body, or
2. support or sustain life and whose failure to perform when properly used in accordance with instructions for use provided in the labeling can be reasonably expected to result in significant injury to the user.

B. A critical component is any component in a life support device or system whose failure to perform can be reasonably expected to cause the failure of the life support device or to affect its safety or effectiveness.

Customers represent that they have all necessary expertise in the safety and regulatory ramifications of their life support devices or systems, and acknowledge and agree that they are solely responsible for all legal, regulatory and safety-related requirements concerning their products and any use of Diodes Incorporated products in such safety-critical, life support devices or systems, notwithstanding any devices- or systems-related information or support that may be provided by Diodes Incorporated. Further, Customers must fully indemnify Diodes Incorporated and its representatives against any damages arising out of the use of Diodes Incorporated products in such safety-critical, life support devices or systems.

Copyright © 2011, Diodes Incorporated

**[www.diodes.com](http://www.diodes.com)**

# Mouser Electronics

Authorized Distributor

Click to View Pricing, Inventory, Delivery & Lifecycle Information:

[Diodes Incorporated:](#)

[DMC2020USD-13](#)