

## Features

- Surface Mount Package Ideally Suited for Automated Insertion
- Low Leakage Current
- Fast Switching Speed
- High Reverse Breakdown Voltage
- **Lead Free By Design/RoHS Compliant (Note 3)**
- **“Green” Device (Note 4)**

## Mechanical Data

- Case: SOD-323
- Case Material: Molded Plastic, “Green” Molding Compound. UL Flammability Classification Rating 94V-0
- Moisture Sensitivity: Level 1 per J-STD-020D
- Terminals: Finish — Matte Tin Finish annealed over Alloy 42 leadframe. Solderable per MIL-STD-202, Method 208
- Polarity: Cathode Band
- Marking Information: See Page 2
- Ordering Information: See Page 2
- Weight: 0.004 grams (approximate)

SOD-323



TOP VIEW

## Maximum Ratings @T<sub>A</sub> = 25°C unless otherwise specified

Characteristic	Symbol	Value	Unit
Peak Repetitive Reverse Voltage	V <sub>RRM</sub>	350	V
Working Peak Reverse Voltage	V <sub>RWM</sub>	300	V
DC Blocking Voltage	V <sub>R</sub>		V
RMS Reverse Voltage	V <sub>R(RMS)</sub>	212	V
Forward Continuous Current	I <sub>FM</sub>	225	mA
Repetitive Peak Forward Current	I <sub>FRM</sub>	625	mA
Non-Repetitive Peak Forward Surge Current	I <sub>FSM</sub>	4.0	A
	@ t = 1.0μs	1.0	
	@ t = 1.0s		

## Thermal Characteristics

Characteristic	Symbol	Value	Unit
Power Dissipation (Note 1)	P <sub>D</sub>	200	mW
Thermal Resistance Junction to Ambient Air (Note 1)	R <sub>θJA</sub>	625	°C/W
Operating and Storage Temperature Range	T <sub>J</sub> , T <sub>STG</sub>	-65 to +150	°C

## Electrical Characteristics @T<sub>A</sub> = 25°C unless otherwise specified

Characteristic	Symbol	Min	Typ	Max	Unit	Test Condition
Reverse Breakdown Voltage (Note 2)	V <sub>(BR)R</sub>	350	—	—	V	I <sub>R</sub> = 150μA
Forward Voltage	V <sub>F</sub>	—	0.78 0.93 1.03	0.87 1.0 1.25	V	I <sub>F</sub> = 20mA I <sub>F</sub> = 100mA I <sub>F</sub> = 200mA
Leakage Current (Note 2)	I <sub>R</sub>	—	30 35	100 100	nA μA	V <sub>R</sub> = 240V, T <sub>J</sub> = 25°C V <sub>R</sub> = 240V, T <sub>J</sub> = 150°C
Total Capacitance	C <sub>T</sub>	—	1.0	5.0	pF	V <sub>R</sub> = 0, f = 1.0MHz
Reverse Recovery Time	t <sub>rr</sub>	—	—	50	ns	I <sub>F</sub> = I <sub>R</sub> = 30mA, I <sub>rr</sub> = 3.0mA, R <sub>L</sub> = 100Ω

- Notes:
1. Part mounted on FR-4 PC board with recommended pad layout, which can be found on our website at <http://www.diodes.com/datasheets/ap02001.pdf>.
  2. Short duration pulse test used to minimize self-heating effect.
  3. No purposefully added lead.
  4. Diodes Inc.'s "Green" policy can be found on our website at [http://www.diodes.com/products/lead\\_free/index.php](http://www.diodes.com/products/lead_free/index.php).

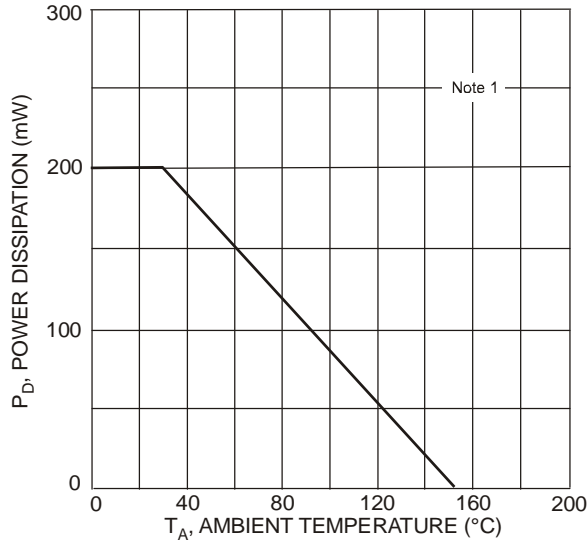

Fig. 1 Power Derating Curve

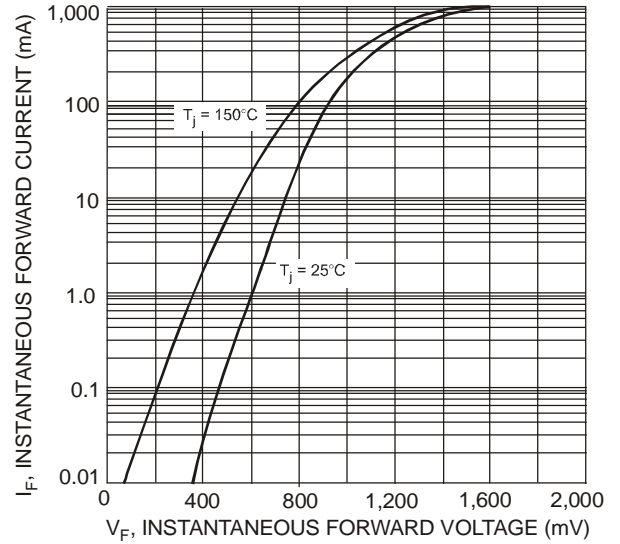

Fig. 2 Typical Forward Characteristics

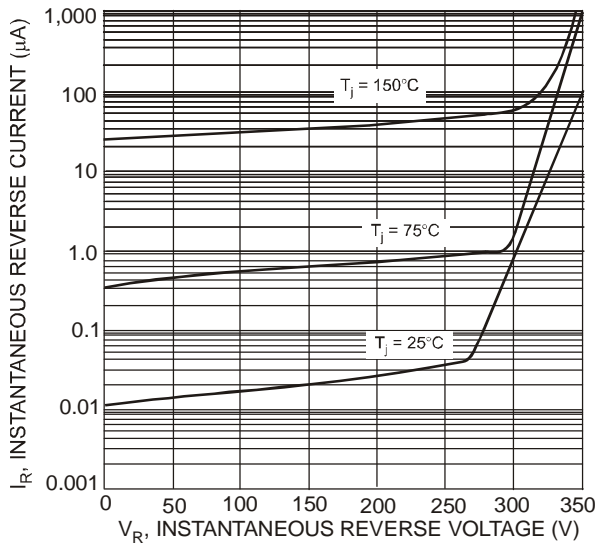

Fig. 3 Typical Reverse Characteristics

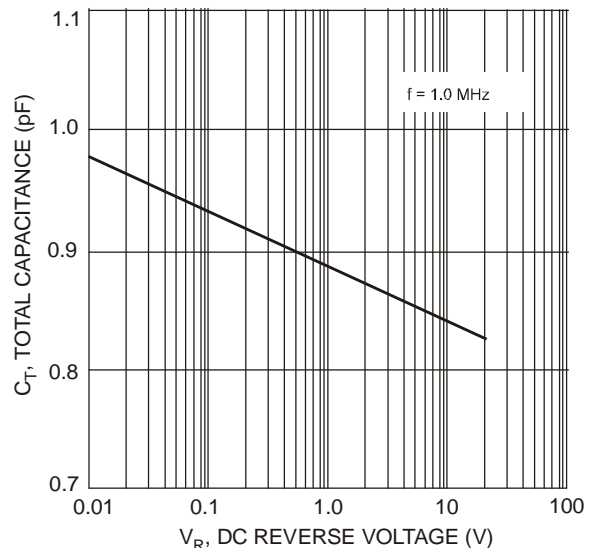

Fig. 4 Total Capacitance vs. Reverse Voltage

**Ordering Information** (Note 5)

Part Number	Case	Packaging
BAV3004WS-7	SOD-323	3000/Tape & Reel

Notes: 5. For packaging details, go to our website at <http://www.diodes.com/datasheets/ap02007.pdf>.

**Marking Information**

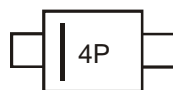

4P = Product Type Marking Code

**Package Outline Dimensions**

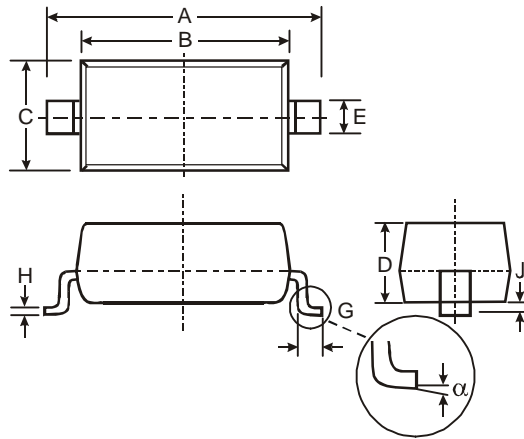

SOD-323		
Dim	Min	Max
A	2.30	2.70
B	1.60	1.80
C	1.20	1.40
D	1.05 Typical	
E	0.25	0.35
G	0.20	0.40
H	0.10	0.15
J	0.00	0.10
α	0°	8°
All Dimensions in mm		

**Suggested Pad Layout**

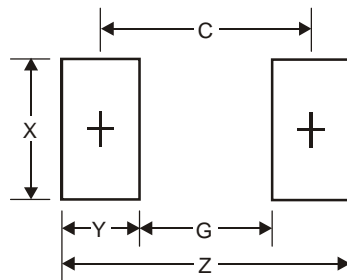

Dimensions	Value (in mm)
Z	3.75
G	1.05
X	0.65
Y	1.35
C	2.40

**IMPORTANT NOTICE**

Diodes Incorporated and its subsidiaries reserve the right to make modifications, enhancements, improvements, corrections or other changes without further notice to any product herein. Diodes Incorporated does not assume any liability arising out of the application or use of any product described herein; neither does it convey any license under its patent rights, nor the rights of others. The user of products in such applications shall assume all risks of such use and will agree to hold Diodes Incorporated and all the companies whose products are represented on our website, harmless against all damages.

**LIFE SUPPORT**

Diodes Incorporated products are not authorized for use as critical components in life support devices or systems without the expressed written approval of the President of Diodes Incorporated.

# Mouser Electronics

Authorized Distributor

Click to View Pricing, Inventory, Delivery & Lifecycle Information:

[Diodes Inc.:](#)

[BAV3004WS-7](#)