



Is Now Part of



ON Semiconductor®

To learn more about ON Semiconductor, please visit our website at
www.onsemi.com

ON Semiconductor and the ON Semiconductor logo are trademarks of Semiconductor Components Industries, LLC dba ON Semiconductor or its subsidiaries in the United States and/or other countries. ON Semiconductor owns the rights to a number of patents, trademarks, copyrights, trade secrets, and other intellectual property. A listing of ON Semiconductor's product/patent coverage may be accessed at www.onsemi.com/site/pdf/Patent-Marking.pdf. ON Semiconductor reserves the right to make changes without further notice to any products herein. ON Semiconductor makes no warranty, representation or guarantee regarding the suitability of its products for any particular purpose, nor does ON Semiconductor assume any liability arising out of the application or use of any product or circuit, and specifically disclaims any and all liability, including without limitation special, consequential or incidental damages. Buyer is responsible for its products and applications using ON Semiconductor products, including compliance with all laws, regulations and safety requirements or standards, regardless of any support or applications information provided by ON Semiconductor. "Typical" parameters which may be provided in ON Semiconductor data sheets and/or specifications can and do vary in different applications and actual performance may vary over time. All operating parameters, including "Typicals" must be validated for each customer application by customer's technical experts. ON Semiconductor does not convey any license under its patent rights nor the rights of others. ON Semiconductor products are not designed, intended, or authorized for use as a critical component in life support systems or any FDA Class 3 medical devices or medical devices with a same or similar classification in a foreign jurisdiction or any devices intended for implantation in the human body. Should Buyer purchase or use ON Semiconductor products for any such unintended or unauthorized application, Buyer shall indemnify and hold ON Semiconductor and its officers, employees, subsidiaries, affiliates, and distributors harmless against all claims, costs, damages, and expenses, and reasonable attorney fees arising out of, directly or indirectly, any claim of personal injury or death associated with such unintended or unauthorized use, even if such claim alleges that ON Semiconductor was negligent regarding the design or manufacture of the part. ON Semiconductor is an Equal Opportunity/Affirmative Action Employer. This literature is subject to all applicable copyright laws and is not for resale in any manner.



FAN7393A

Half-Bridge Gate Drive IC

Features

- Floating Channel for Bootstrap Operation to +600V
- Typically 2.5A/2.5A Sourcing/Sinking Current Driving Capability
- Extended Allowable Negative V_S Swing to -9.8V for Signal Propagation at $V_{BS}=15V$
- High-Side Output in Phase of IN Input Signal
- 3.3V and 5V Input Logic Compatible
- Matched Propagation Delay for Both Channels
- Built-in Shutdown Function
- Built-in UVLO Functions for Both Channels
- Built-in Common-Mode dv/dt Noise Cancelling Circuit
- Internal 400ns Minimum Dead Time at $R_{DT}=0\Omega$
- Programmable Turn-On Delay Control (Dead-Time)

Applications

- High-Speed Power MOSFET and IGBT Gate Driver
- Induction Heating
- High-Power DC-DC Converter
- Synchronous Step-Down Converter
- Motor Drive Inverter

Description

The FAN7393A is a half-bridge gate-drive IC with shut-down and programmable dead-time control functions that can drive high-speed MOSFETs and Isolated Gate Bridge Transistors (IGBTs) operating up to +600V. It has a buffered output stage with all NMOS transistors designed for high-pulse-current driving capability and minimum cross-conduction.

Fairchild's high-voltage process and common-mode noise canceling techniques provide stable operation of the high-side driver under high dv/dt noise circumstances. An advanced level-shift circuit offers high-side gate driver operation up to $V_S=-9.8V$ (typical) for $V_{BS}=15V$.

The UVLO circuit prevents malfunction when V_{DD} and V_{BS} are lower than the specified threshold voltage.

The high-current and low-output voltage drop feature makes this device suitable for diverse half- and full-bridge inverters; motor drive inverters, switching mode power supplies, induction heating, and high-power DC-DC converter applications.

14-SOP

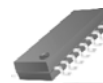

Ordering Information

Part Number	Package	Operating Temperature	Packing Method
FAN7393AMX	14-SOIC	-40°C to +125°C	Tape & Reel

Typical Application Diagrams

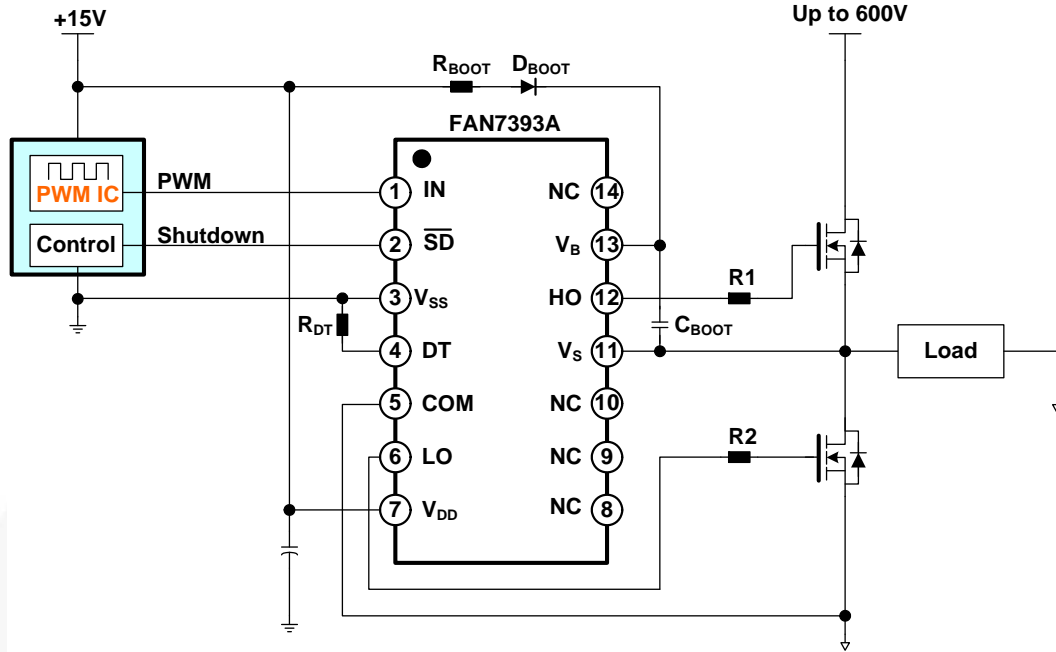

Figure 1. Typical Application Circuit

Internal Block Diagram

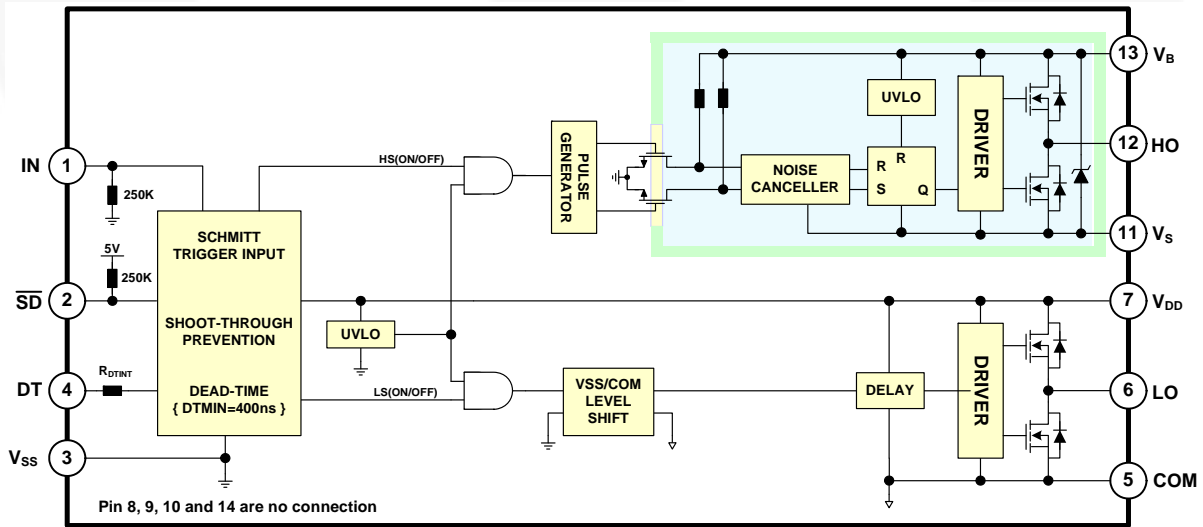

Figure 2. Functional Block Diagram

Pin Configuration

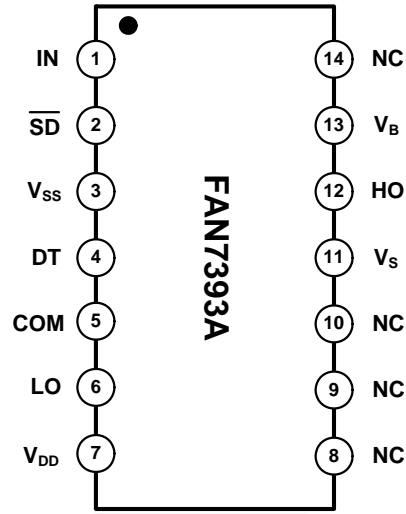

Figure 3. Pin Configurations (Top View)

Pin Definitions

Pin #	Name	Description
1	IN	Logic Input for High-Side and Low-Side Gate Driver Output, In-Phase with HO
2	$\overline{\text{SD}}$	Logic Input for Shutdown
3	V_{SS}	Logic Ground
4	DT	Dead-Time Control with External Resistor (Referenced to V_{SS})
5	COM	Ground
6	LO	Low-Side Driver Return
7	V_{DD}	Supply Voltage
8	NC	No Connection
9	NC	No Connection
10	NC	No Connection
11	V_S	High-Voltage Floating Supply Return
12	HO	High-Side Driver Output
13	V_B	High-Side Floating Supply
14	NC	No Connection

Absolute Maximum Ratings

Stresses exceeding the absolute maximum ratings may damage the device. The device may not function or be operable above the recommended operating conditions and stressing the parts to these levels is not recommended. In addition, extended exposure to stresses above the recommended operating conditions may affect device reliability. The absolute maximum ratings are stress ratings only. $T_A=25^{\circ}\text{C}$ unless otherwise specified.

Symbol	Characteristics	Min.	Max.	Unit
V_B	High-Side Floating Supply Voltage	-0.3	625.0	V
V_S	High-Side Floating Offset Voltage ⁽¹⁾	$V_B - V_{SHUNT}$	$V_B + 0.3$	V
V_{HO}	High-Side Floating Output Voltage	$V_S - 0.3$	$V_B + 0.3$	V
V_{LO}	Low-Side Output Voltage	-0.3	$V_{DD} + 0.3$	V
V_{DD}	Low-Side and Logic Fixed Supply Voltage	-0.3	25.0	V
V_{IN}	Logic Input Voltage (IN)	-0.3	$V_{DD} + 0.3$	V
V_{SD}	Logic Input Voltage (\overline{SD})	V_{SS}	5.5	V
DT	Programmable Dead-Time Pin Voltage	-0.3	$V_{DD} + 0.3$	V
V_{SS}	Logic Ground	$V_{DD} - 25$	$V_{DD} + 0.3$	V
dV_S/dt	Allowable Offset Voltage Slew Rate		± 50	V/ns
P_D	Power Dissipation ^(2, 3, 4)		1	W
θ_{JA}	Thermal Resistance		110	$^{\circ}\text{C}/\text{W}$
T_J	Junction Temperature		+150	$^{\circ}\text{C}$
T_{STG}	Storage Temperature	-55	+150	$^{\circ}\text{C}$

Notes:

- This IC contains a shunt regulator on V_{BS} . This supply pin should not be driven by a low-impedance voltage source greater than V_{SHUNT} specified in the Electrical Characteristics section.
- Mounted on 76.2 x 114.3 x 1.6mm PCB (FR-4 glass epoxy material).
- Refer to the following standards:
JESD51-2: Integral circuits thermal test method environmental conditions - natural convection, and
JESD51-3: Low effective thermal conductivity test board for leaded surface mount packages.
- Do not exceed maximum P_D under any circumstances.

Recommended Operating Conditions

The Recommended Operating Conditions table defines the conditions for actual device operation. Recommended operating conditions are specified to ensure optimal performance to the datasheet specifications. Fairchild does not recommend exceeding them or designing to absolute maximum ratings.

Symbol	Parameter	Min.	Max.	Unit
V_B	High-Side Floating Supply Voltage	$V_S + 10$	$V_S + 20$	V
V_S	High-Side Floating Supply Offset Voltage	$6 - V_{DD}$	600	V
V_{HO}	High-Side Output Voltage	V_S	V_B	V
V_{DD}	Low-Side and Logic Fixed Supply Voltage	10	20	V
V_{LO}	Low-Side Output Voltage	COM	V_{DD}	V
V_{IN}	Logic Input Voltage (IN)	V_{SS}	V_{DD}	V
V_{SD}	Logic Input Voltage (\overline{SD})	V_{SS}	5	V
DT	Programmable Dead-Time Pin Voltage	V_{SS}	V_{DD}	V
V_{SS}	Logic Ground	-5	+5	V
T_A	Operating Ambient Temperature	-40	+125	$^{\circ}\text{C}$

Electrical Characteristics

$V_{BIAS}(V_{DD}, V_{BS})=15.0V$, $V_{SS}=COM=0V$, $DT=V_{SS}$, and $T_A=25^\circ C$ unless otherwise specified. The V_{IN} and I_{IN} parameters are referenced to V_{SS}/COM and are applicable to the respective input leads: IN and SD. The V_O and I_O parameters are referenced to COM and are applicable to the respective output leads: HO and LO.

Symbol	Characteristics	Test Condition	Min.	Typ.	Max.	Unit
POWER SUPPLY SECTION						
I_{QDD}	Quiescent V_{DD} Supply Current	$V_{IN}=0V$ or $5V$		600	1000	μA
I_{QBS}	Quiescent V_{BS} Supply Current	$V_{IN}=0V$ or $5V$		55	100	μA
I_{PDD}	Operating V_{DD} Supply Current	$f_{IN}=20KHz$, No Load		1.0	1.6	mA
I_{PBS}	Operating V_{BS} Supply Current	$C_L=1nF$, $f_{IN}=20KHz$, RMS		450	800	μA
I_{SD}	Shutdown Mode Supply Current	$\overline{SD}=V_{SS}$		650	1000	μA
I_{LK}	Offset Supply Leakage Current	$V_B=V_S=600V$			10	μA
BOOTSTRAPPED SUPPLY SECTION						
V_{DDUV+} V_{BSUV+}	V_{DD} and V_{BS} Supply Under-Voltage Positive-Going Threshold Voltage	$V_{IN}=0V$, $V_{DD}=V_{BS}=\text{Sweep}$	7.8	8.8	9.8	V
V_{DDUV-} V_{BSUV-}	V_{DD} and V_{BS} Supply Under-Voltage Negative-Going Threshold Voltage	$V_{IN}=0V$, $V_{DD}=V_{BS}=\text{Sweep}$	7.3	8.3	9.3	V
V_{DDUVH-} V_{BSUVH}	V_{DD} and V_{BS} Supply Under-Voltage Lockout Hysteresis Voltage	$V_{IN}=0V$, $V_{DD}=V_{BS}=\text{Sweep}$		0.5		V
SHUNT REGULATOR SECTION						
V_{SHUNT}	Shunt Regulator Clamping Voltage for V_{BS}	$V_{BS}=\text{Sweep}$, $I_{SHUNT}=5mA$	21	23	25	V
INPUT LOGIC SECTION						
V_{IH}	Logic "1" Input Voltage for HO & Logic "0" for LO		2.5			V
V_{IL}	Logic "0" Input Voltage for HO & Logic "1" for LO				0.8	V
I_{IN+}	Logic Input High Bias Current	$V_{IN}=5V$, $\overline{SD}=0V$		20	50	μA
I_{IN-}	Logic Input Low Bias Current	$V_{IN}=0V$, $\overline{SD}=5V$			3	μA
R_{IN}	Logic Input Pull-Down Resistance		100	250		$K\Omega$
$V_{SDCLAMP}$	Shutdown (\overline{SD}) Input Clamping Voltage ⁽⁵⁾			5.0	5.5	V
$\overline{SD+}$	Shutdown (\overline{SD}) Input Positive-Going Threshold		2.5			V
$\overline{SD-}$	Shutdown (\overline{SD}) Input Negative-Going Threshold				0.8	V
R_{PSD}	Shutdown (\overline{SD}) Input Pull-Up Resistance		100	250		$K\Omega$
GATE DRIVER OUTPUT SECTION						
V_{OH}	High-Level Output Voltage ($V_{BIAS} - V_O$)	No Load ($I_O=0A$)			1.5	V
V_{OL}	Low-Level Output Voltage	No Load ($I_O=0A$)			100	mV
I_{O+}	Output High, Short-Circuit Pulsed Current ⁽⁵⁾	$V_{HO}=0V$, $V_{IN}=5V$, $PW \leq 10\mu s$	2.0	2.5		A
I_{O-}	Output Low, Short-Circuit Pulsed Current ⁽⁵⁾	$V_{HO}=15V$, $V_{IN}=0V$, $PW \leq 10\mu s$	2.0	2.5		A
V_{SS}/COM	$V_{SS}-COM/COM-V_{SS}$ Voltage Endurance ⁽⁵⁾		-5.0		5.0	V
V_S	Allowable Negative V_S Pin Voltage for IN Signal Propagation to HO			-9.8	-7.0	V

Note:

5 These parameters are guaranteed by design.

Dynamic Electrical Characteristics

$V_{BIAS}(V_{DD}, V_{BS})=15.0V$, $V_{SS}=COM=0V$, $C_L=1000pF$, $DT=V_{SS}$, and $T_A=25^\circ C$, unless otherwise specified.

Symbol	Parameter	Conditions	Min.	Typ.	Max.	Unit
t_{ON}	Turn-On Propagation Delay ⁽⁶⁾	$V_S=0V$, $R_{DT}=0\Omega$		530	730	ns
t_{OFF}	Turn-Off Propagation Delay	$V_S=0V$		130	250	ns
t_{SD}	Shutdown Propagation Delay			140	210	ns
Mt_{ON}	Delay Matching, HO and LO Turn-On			0	90	ns
Mt_{OFF}	Delay Matching, HO and LO Turn-Off			0	40	ns
t_R	Turn-On Rise Time	$V_S=0V$		25	50	ns
t_F	Turn-Off Fall Time	$V_S=0V$		15	35	ns
DT	Dead Time: LO Turn-Off to HO Turn-On, HO Turn-Off to LO Turn-On	$R_{DT}=0\Omega$	300	400	500	ns
		$R_{DT}=200K\Omega$	4	5	6	μs
MDT	Dead-Time Matching= $ DT_{LO-HO} - DT_{HO-LO} $	$R_{DT}=0\Omega$		0	40	ns
		$R_{DT}=200K\Omega$		0	500	ns

Note:

6 The turn-on propagation delay includes dead time.

Typical Characteristics

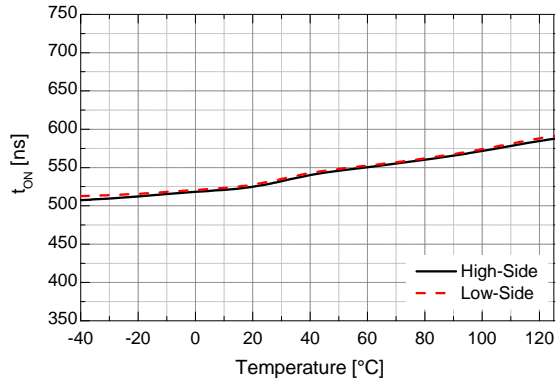

Figure 4. Turn-On Propagation Delay vs. Temperature

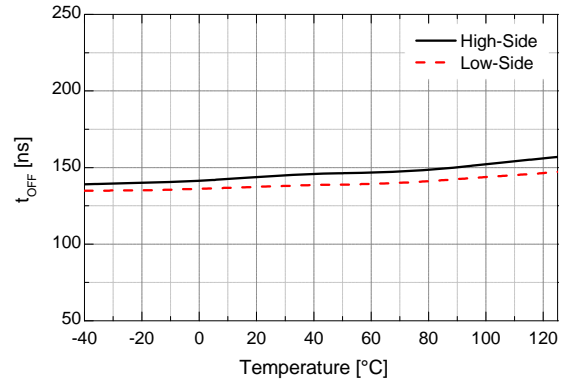

Figure 5. Turn-Off Propagation Delay vs. Temperature

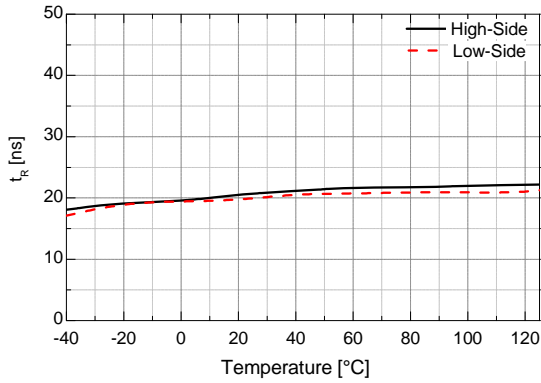

Figure 6. Turn-On Rise Time vs. Temperature

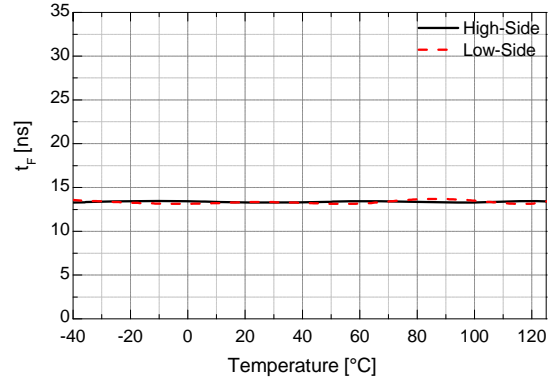

Figure 7. Turn-Off Fall Time vs. Temperature

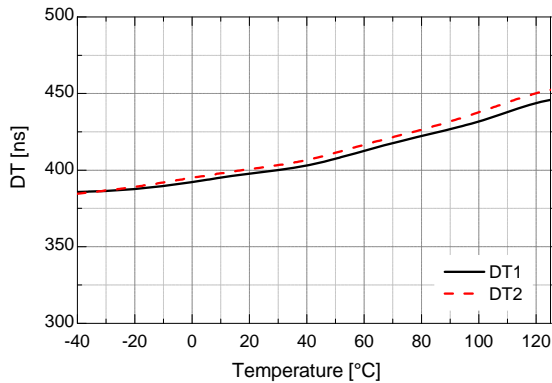

Figure 8. Dead Time ($R_{DT}=0\Omega$) vs. Temperature

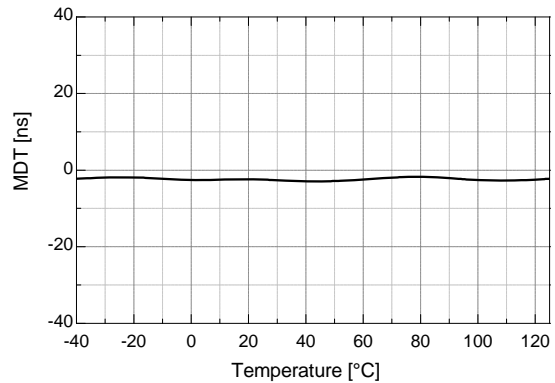

Figure 9. Dead Time Matching ($R_{DT}=0\Omega$) vs. Temperature

Typical Characteristics (Continued)

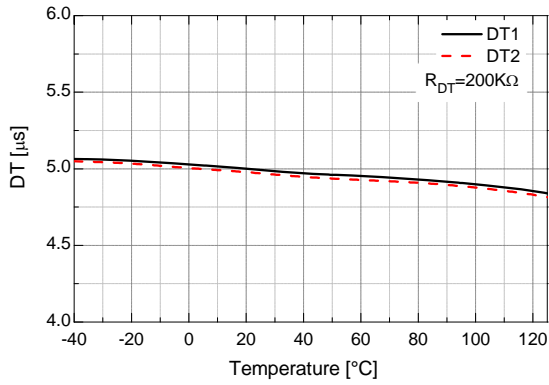

Figure 10. Dead Time ($R_{DT}=200K\Omega$) vs. Temperature

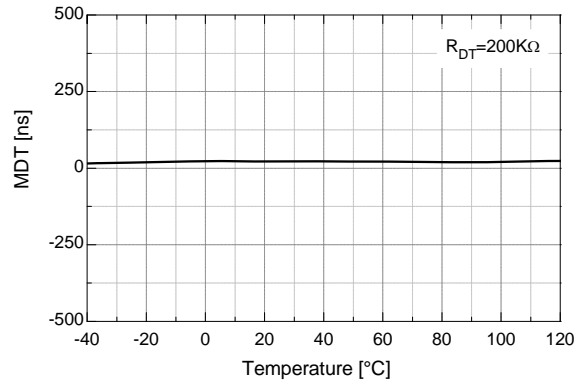

Figure 11. Dead-Time Matching ($R_{DT}=200K\Omega$) vs. Temperature

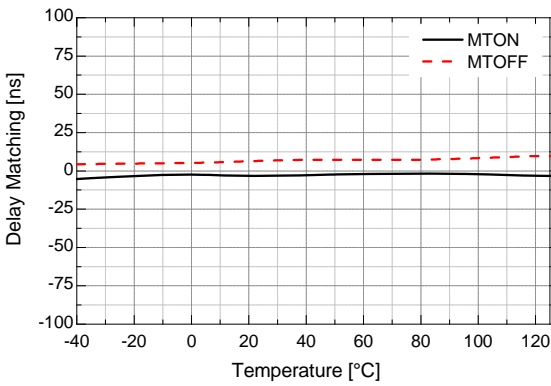

Figure 12. Delay Matching vs. Temperature

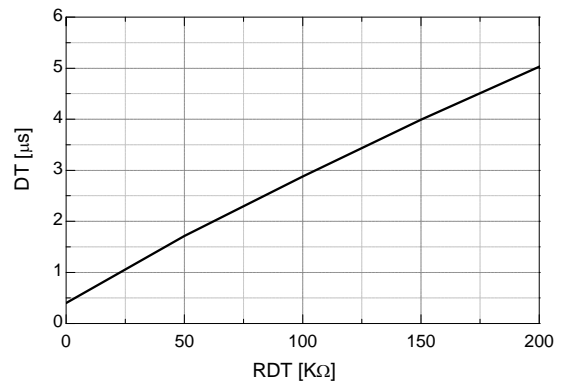

Figure 13. Dead Time vs. R_{DT}

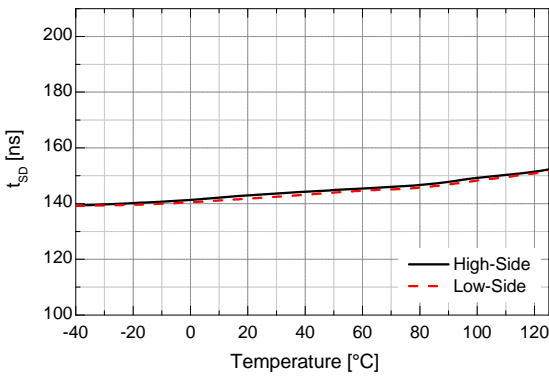

Figure 14. Shutdown Propagation Delay vs. Temperature

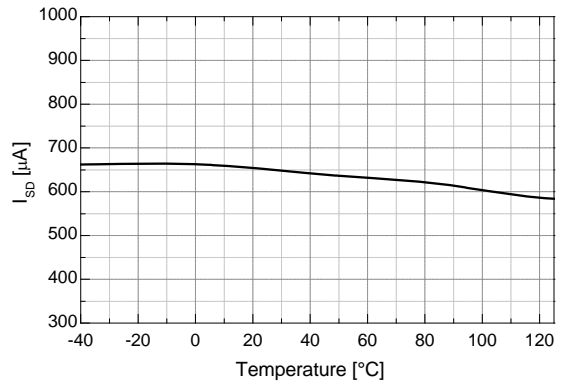

Figure 15. Shutdown Mode Supply Current vs. Temperature

Typical Characteristics (Continued)

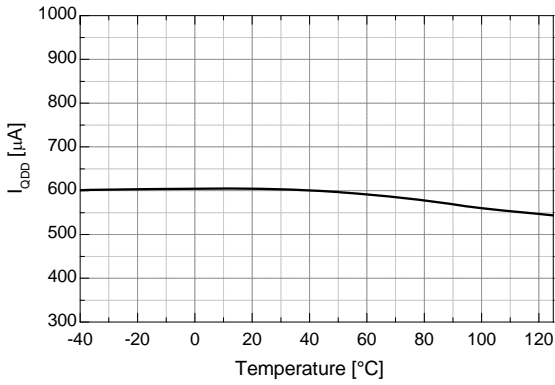

Figure 16. Quiescent V_{DD} Supply Current vs. Temperature

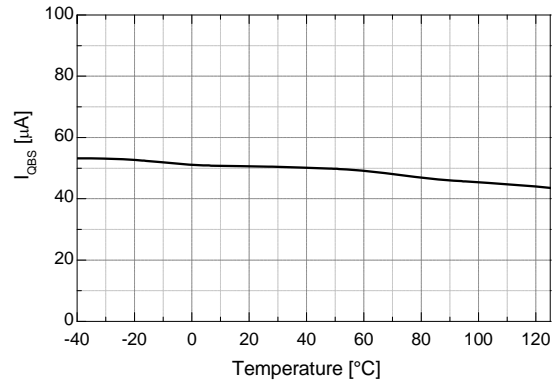

Figure 17. Quiescent V_{BS} Supply Current vs. Temperature

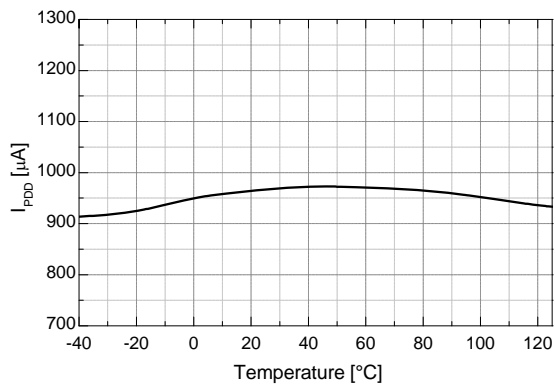

Figure 18. Operating V_{DD} Supply Current vs. Temperature

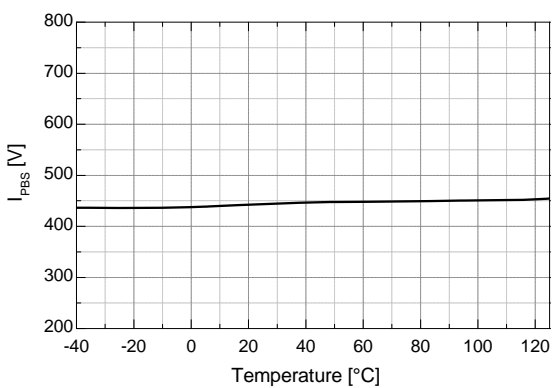

Figure 19. Operating V_{BS} Supply Current vs. Temperature

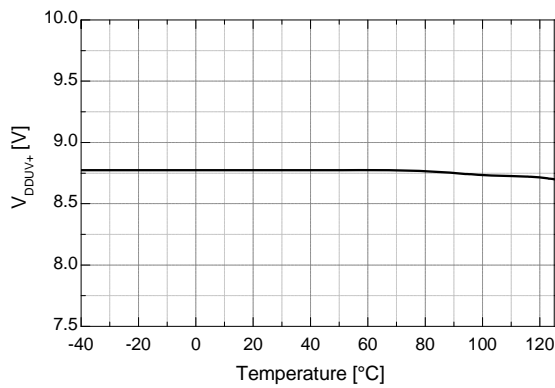

Figure 20. V_{DD} UVLO+ vs. Temperature

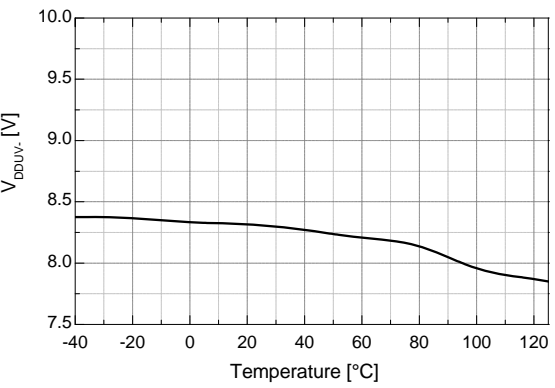

Figure 21. V_{DD} UVLO- vs. Temperature

Typical Characteristics (Continued)

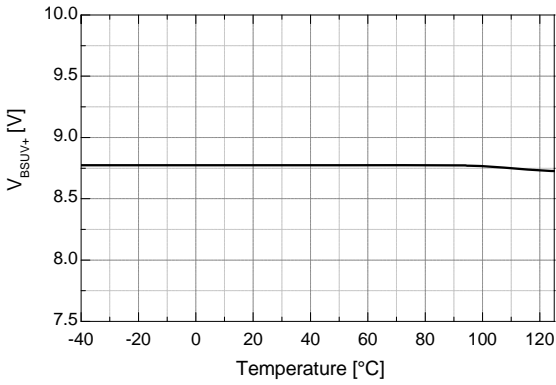

Figure 22. V_{BS} UVLO+ vs. Temperature

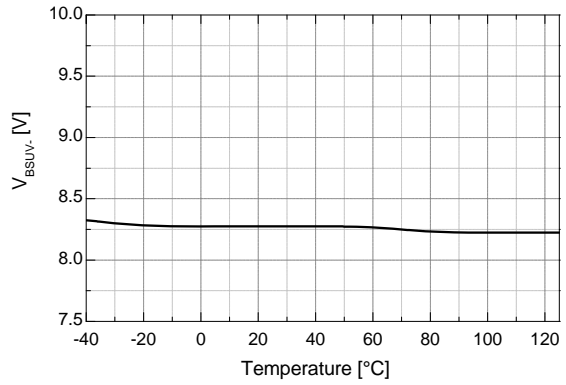

Figure 23. V_{BS} UVLO- vs. Temperature

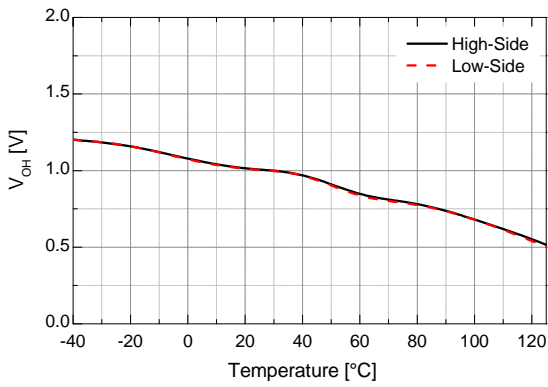

Figure 24. High-Level Output Voltage vs. Temperature

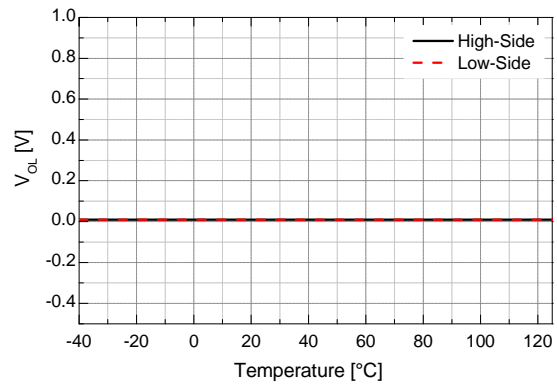

Figure 25. Low-Level Output Voltage vs. Temperature

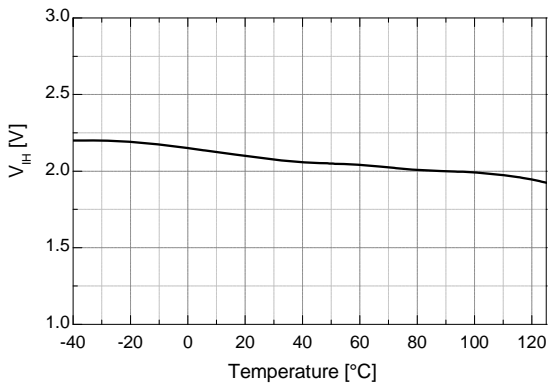

Figure 26. Logic HIGH Input Voltage vs. Temperature

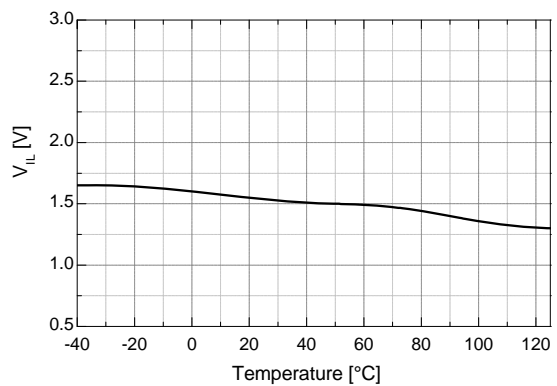

Figure 27. Logic LOW Input Voltage vs. Temperature

Typical Characteristics (Continued)

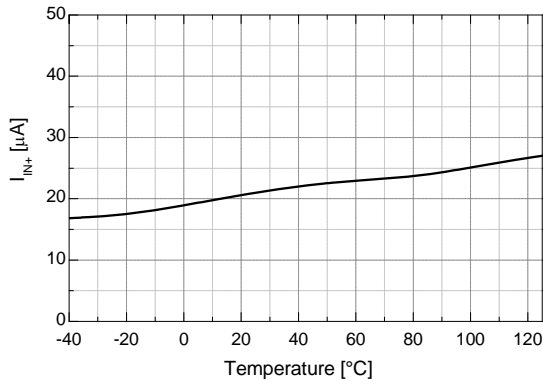

Figure 28. Logic Input High Bias Current vs. Temperature

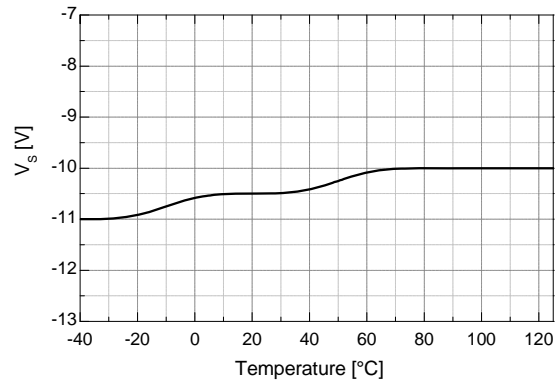

Figure 29. Allowable Negative V_S Voltage vs. Temperature

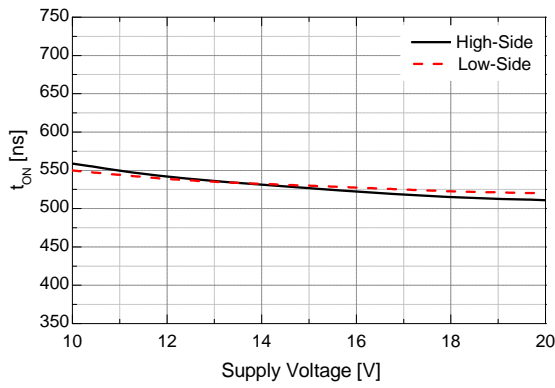

Figure 30. Turn-On Propagation Delay vs. Supply Voltage

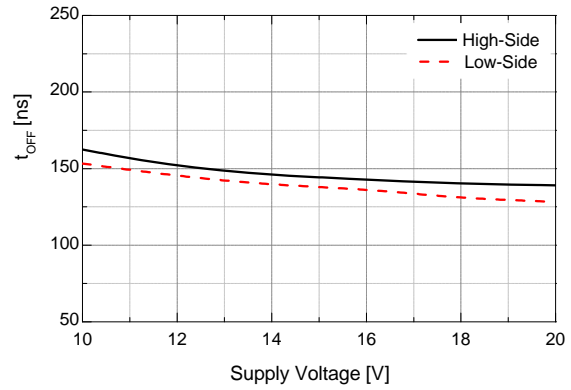

Figure 31. Turn-Off Propagation Delay vs. Supply Voltage

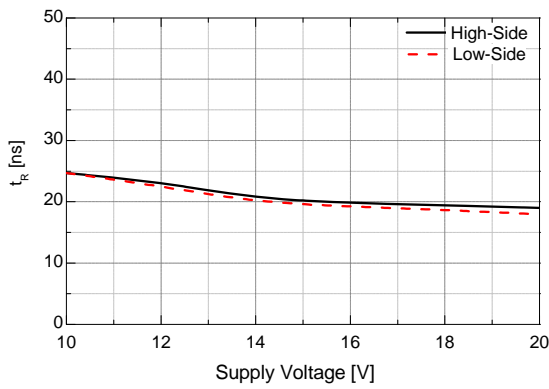

Figure 32. Turn-On Rise Time vs. Supply Voltage

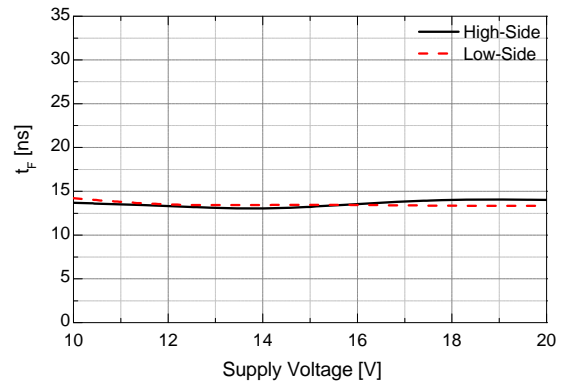

Figure 33. Turn-Off Fall Time vs. Supply Voltage

Typical Characteristics (Continued)

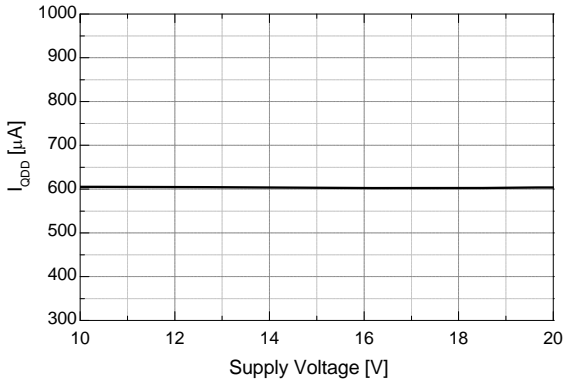

Figure 34. Quiescent V_{DD} Supply Current vs. Supply Voltage

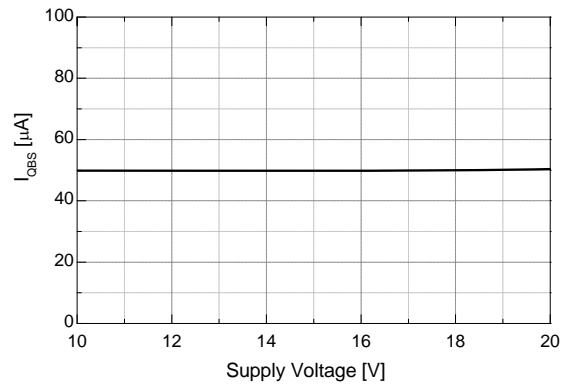

Figure 35. Quiescent V_{BS} Supply Current vs. Supply Voltage

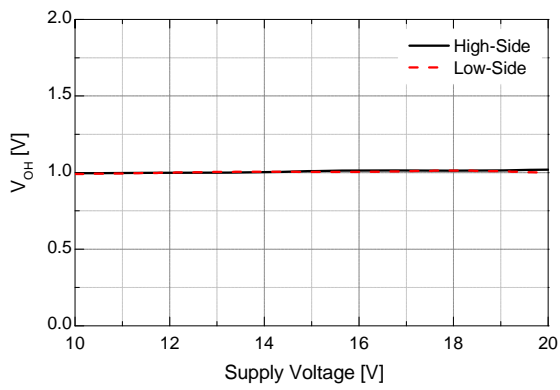

Figure 36. High-Level Output Voltage vs. Supply Voltage

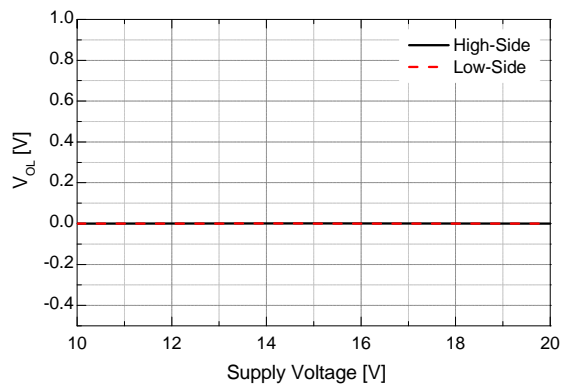

Figure 37. Low-Level Output Voltage vs. Supply Voltage

Switching Time Definitions

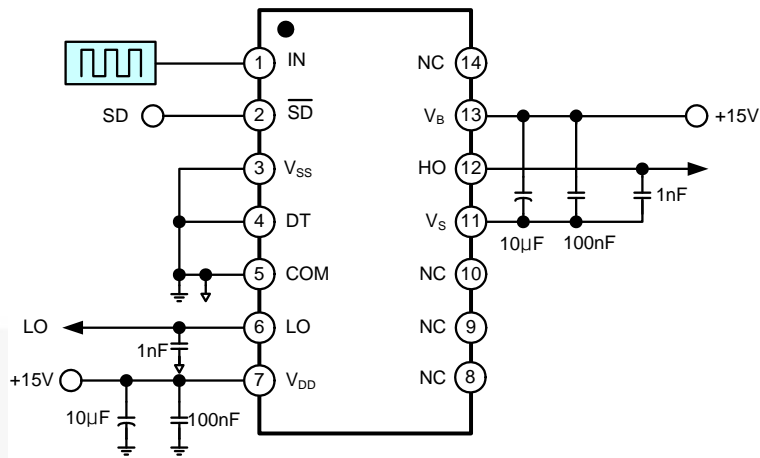

Figure 38. Switching Time Test Circuit

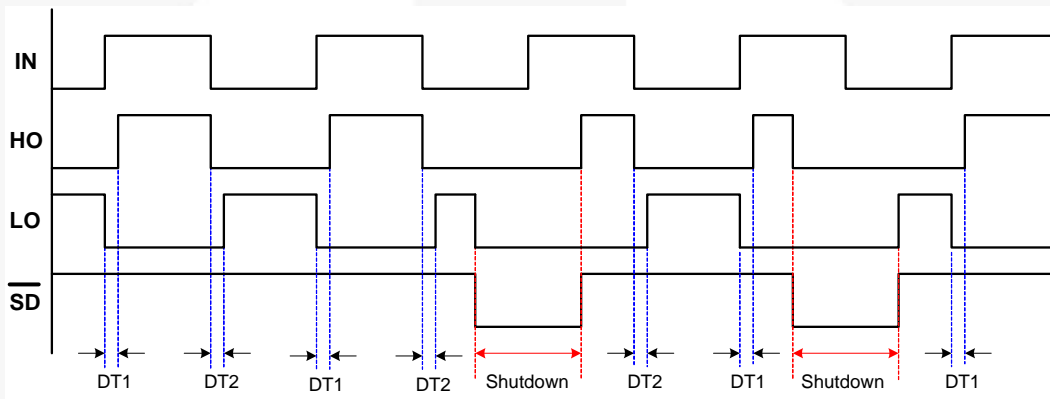

Figure 39. Input / Output Timing Diagram

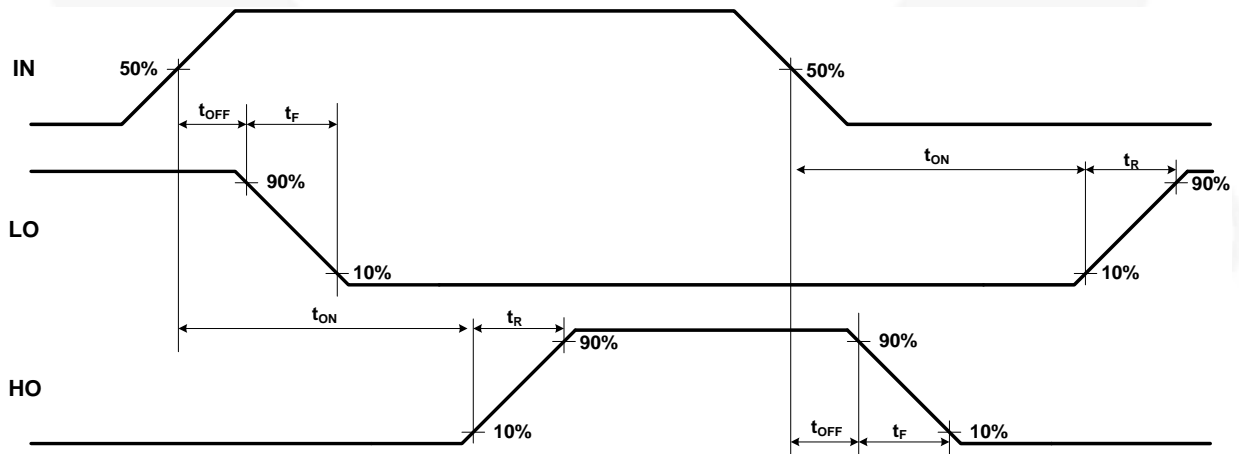

Figure 40. Switching Time Waveform Definition

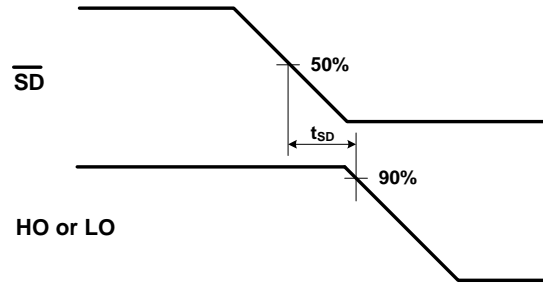

Figure 41. Shutdown Waveform Definition

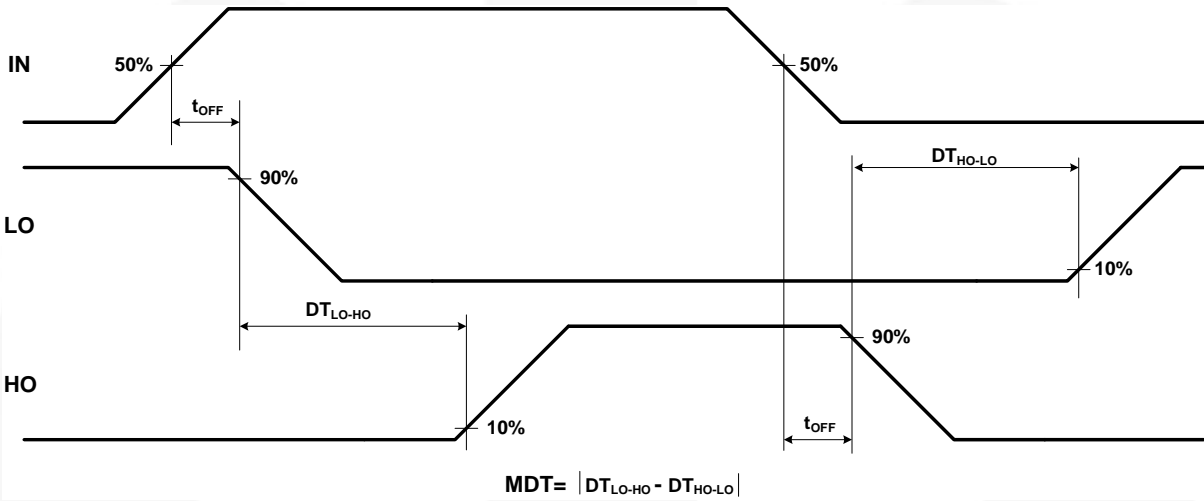

Figure 42. Dead-Time Waveform Definition

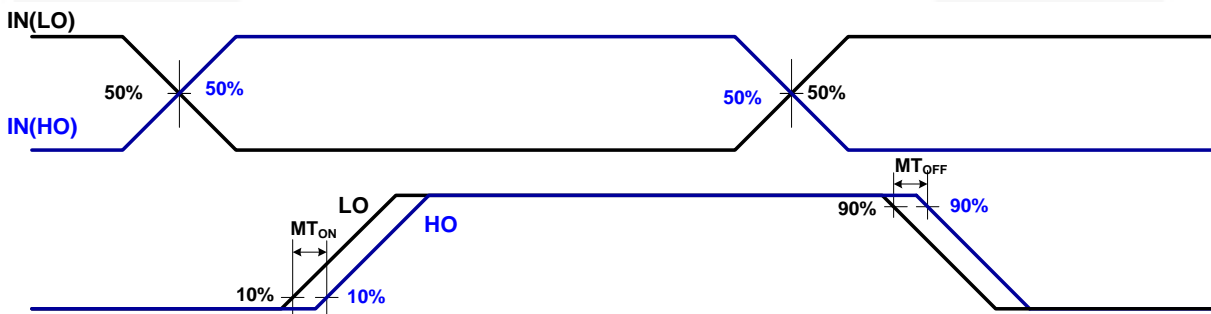
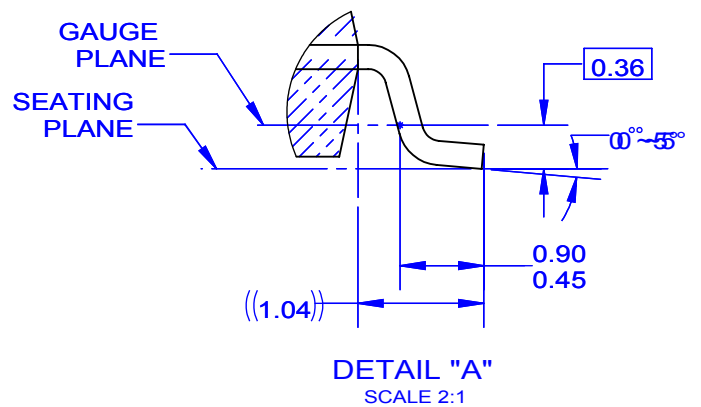
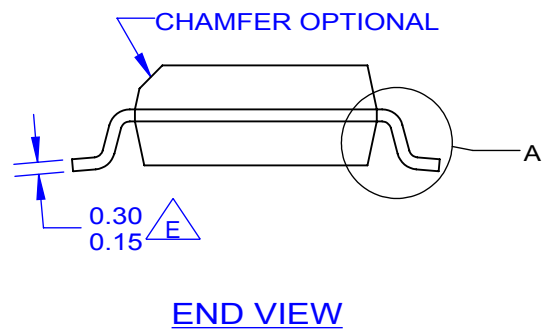
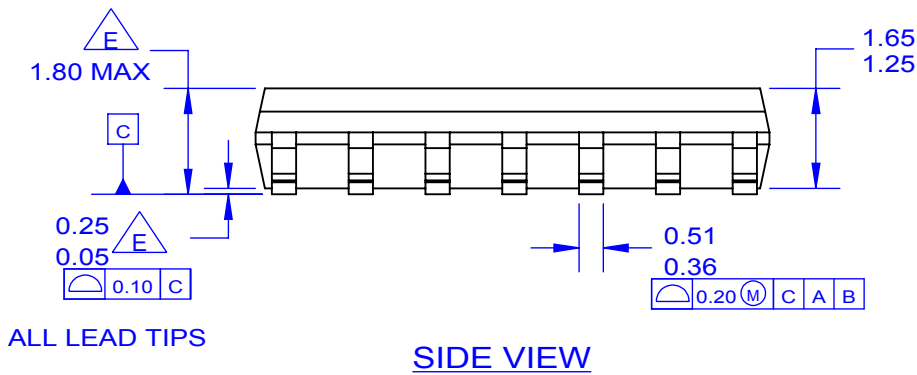
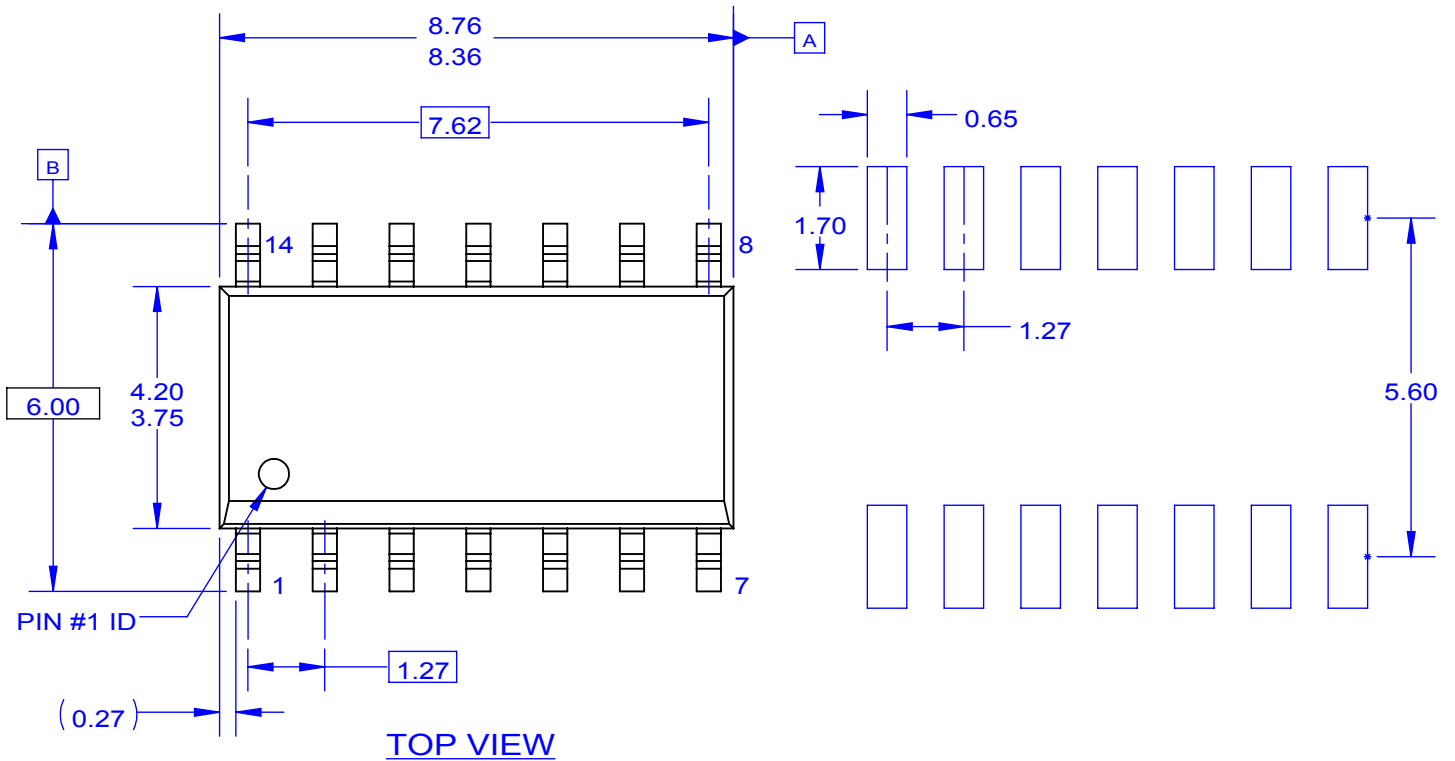

Figure 43. Delay Matching Waveform Definition



NOTES: UNLESS OTHERWISE SPECIFIED

A. THIS PACKAGE REFERENCE TO JEDEC MS-012 VARIATION AB.

B. ALL DIMENSIONS ARE IN MILLIMETERS.

C. DIMENSIONS ARE EXCLUSIVE OF BURRS, MOLD FLASH AND TIE BAR EXTRUSIONS.

D. DIMENSIONS AND TOLERANCES AS PER ASME Y14.5-1994.

E. OUT OF JEDEC STANDARD VALUE.

F. LAND PATTERN STANDARD: SOIC127P600X145-14M.

G. FILE NAME: MKT-M14C REV2



TRADEMARKS

The following includes registered and unregistered trademarks and service marks, owned by Fairchild Semiconductor and/or its global subsidiaries, and is not intended to be an exhaustive list of all such trademarks.

AccuPower™
AttitudeEngine™
Awinda®
AX-CAP®*
BitSiC™
Build it Now™
CorePLUS™
CorePOWER™
CROSSVOL™
CTL™
Current Transfer Logic™
DEUXPEED®
Dual Cool™
EcoSPARK®
EfficientMax™
ESBC™
F®
Fairchild®
Fairchild Semiconductor®
FACT Quiet Series™
FACT®
FastvCore™
FETBench™
FPS™

F-PFS™
FRFET®
Global Power Resource™
GreenBridge™
Green FPS™
Green FPS™ e-Series™
Gmax™
GTO™
IntelliMAX™
ISOPLANAR™
Making Small Speakers Sound Louder and Better™
MegaBuck™
MICROCOUPLER™
MicroFET™
MicroPak™
MicroPak2™
MillerDrive™
MotionMax™
MotionGrid®
MTi®
MTx®
MVN®
mWSaver®
OptoHiT™
OPTOLOGIC®

OPTOPLANAR®
Power Supply WebDesigner™
PowerTrench®
PowerXS™
Programmable Active Droop™
QFET®
QS™
Quiet Series™
RapidConfigure™
Saving our world, 1mW/W/kW at a time™
SignalWise™
SmartMax™
SMART START™
Solutions for Your Success™
SPM®
STEALTH™
SuperFET®
SuperSOT™-3
SuperSOT™-6
SuperSOT™-8
SupreMOS®
SyncFET™
Sync-Lock™

SYSTEM GENERAL®
TinyBoost®
TinyBuck®
TinyCalc™
TinyLogic®
TINYOPTO™
TinyPower™
TinyPWM™
TinyWire™
TranSiC™
TriFault Detect™
TRUECURRENT®*
µSerDes™
SerDes®
UHC®
Ultra FRFET™
UniFET™
VCX™
VisualMax™
VoltagePlus™
XS™
Xsens™
仙童®

* Trademarks of System General Corporation, used under license by Fairchild Semiconductor.

DISCLAIMER

FAIRCHILD SEMICONDUCTOR RESERVES THE RIGHT TO MAKE CHANGES WITHOUT FURTHER NOTICE TO ANY PRODUCTS HEREIN TO IMPROVE RELIABILITY, FUNCTION, OR DESIGN. TO OBTAIN THE LATEST, MOST UP-TO-DATE DATASHEET AND PRODUCT INFORMATION, VISIT OUR WEBSITE AT [HTTP://WWW.FAIRCHILDSEMI.COM](http://www.fairchildsemi.com). FAIRCHILD DOES NOT ASSUME ANY LIABILITY ARISING OUT OF THE APPLICATION OR USE OF ANY PRODUCT OR CIRCUIT DESCRIBED HEREIN; NEITHER DOES IT CONVEY ANY LICENSE UNDER ITS PATENT RIGHTS, NOR THE RIGHTS OF OTHERS. THESE SPECIFICATIONS DO NOT EXPAND THE TERMS OF FAIRCHILD'S WORLDWIDE TERMS AND CONDITIONS, SPECIFICALLY THE WARRANTY THEREIN, WHICH COVERS THESE PRODUCTS.

AUTHORIZED USE

Unless otherwise specified in this data sheet, this product is a standard commercial product and is not intended for use in applications that require extraordinary levels of quality and reliability. This product may not be used in the following applications, unless specifically approved in writing by a Fairchild officer: (1) automotive or other transportation, (2) military/aerospace, (3) any safety critical application – including life critical medical equipment – where the failure of the Fairchild product reasonably would be expected to result in personal injury, death or property damage. Customer's use of this product is subject to agreement of this Authorized Use policy. In the event of an unauthorized use of Fairchild's product, Fairchild accepts no liability in the event of product failure. In other respects, this product shall be subject to Fairchild's Worldwide Terms and Conditions of Sale, unless a separate agreement has been signed by both Parties.

ANTI-COUNTERFEITING POLICY

Fairchild Semiconductor Corporation's Anti-Counterfeiting Policy. Fairchild's Anti-Counterfeiting Policy is also stated on our external website, www.fairchildsemi.com, under Terms of Use

Counterfeiting of semiconductor parts is a growing problem in the industry. All manufacturers of semiconductor products are experiencing counterfeiting of their parts. Customers who inadvertently purchase counterfeit parts experience many problems such as loss of brand reputation, substandard performance, failed applications, and increased cost of production and manufacturing delays. Fairchild is taking strong measures to protect ourselves and our customers from the proliferation of counterfeit parts. Fairchild strongly encourages customers to purchase Fairchild parts either directly from Fairchild or from Authorized Fairchild Distributors who are listed by country on our web page cited above. Products customers buy either from Fairchild directly or from Authorized Fairchild Distributors are genuine parts, have full traceability, meet Fairchild's quality standards for handling and storage and provide access to Fairchild's full range of up-to-date technical and product information. Fairchild and our Authorized Distributors will stand behind all warranties and will appropriately address any warranty issues that may arise. Fairchild will not provide any warranty coverage or other assistance for parts bought from Unauthorized Sources. Fairchild is committed to combat this global problem and encourage our customers to do their part in stopping this practice by buying direct or from authorized distributors.

PRODUCT STATUS DEFINITIONS

Definition of Terms

Datasheet Identification	Product Status	Definition
Advance Information	Formative / In Design	Datasheet contains the design specifications for product development. Specifications may change in any manner without notice.
Preliminary	First Production	Datasheet contains preliminary data; supplementary data will be published at a later date. Fairchild Semiconductor reserves the right to make changes at any time without notice to improve design.
No Identification Needed	Full Production	Datasheet contains final specifications. Fairchild Semiconductor reserves the right to make changes at any time without notice to improve the design.
Obsolete	Not In Production	Datasheet contains specifications on a product that is discontinued by Fairchild Semiconductor. The datasheet is for reference information only.

Mouser Electronics

Authorized Distributor

Click to View Pricing, Inventory, Delivery & Lifecycle Information:

[Fairchild Semiconductor:](#)

[FAN7393AM](#) [FAN7393AMX](#)