



FDB0190N807L

N-Channel PowerTrench[®] MOSFET

80 V, 270 A, 1.7 mΩ

Features

- Max $r_{DS(on)}$ = 1.7 mΩ at $V_{GS} = 10$ V, $I_D = 34$ A
- Max $r_{DS(on)}$ = 2 mΩ at $V_{GS} = 8$ V, $I_D = 31$ A
- Fast Switching Speed
- Low Gate Charge
- High Performance Trench Technology for Extremely Low $R_{DS(on)}$
- High Power and Current Handling Capability
- RoHS Compliant



General Description

This N-Channel MOSFET is produced using Fairchild Semiconductor's advance PowerTrench[®] process that has been especially tailored to minimize the on-state resistance while maintaining superior ruggedness and switching performance for industrial applications.

Applications

- Industrial Motor Drive
- Industrial Power Supply
- Industrial Automation
- Battery Operated tools
- Battery Protection
- Solar Inverters
- UPS and Energy Inverters
- Energy Storage
- Load Switch

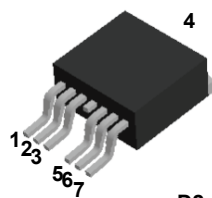

1. Gate
2. Source/Kelvin Sense
3. Source/Kelvin Sense
4. Drain
5. Source
6. Source
7. Source

D2-PAK
(TO263)

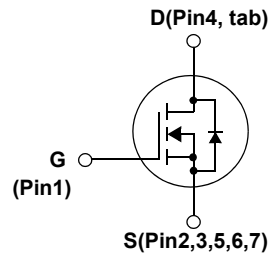

MOSFET Maximum Ratings $T_C = 25^\circ\text{C}$ unless otherwise noted.

Symbol	Parameter	Conditions	Rated Value	Units
V_{DS}	Drain to Source Voltage		80	V
V_{GS}	Gate to Source Voltage		± 20	V
I_D	Drain Current	-Continuous $T_C = 25^\circ\text{C}$ (Note 5)	270	A
		-Continuous $T_C = 100^\circ\text{C}$ (Note 5)	190	
		-Pulsed (Note 4)	1440	
E_{AS}	Single Pulse Avalanche Energy	(Note 3)	777	mJ
P_D	Power Dissipation	$T_C = 25^\circ\text{C}$	250	W
	Power Dissipation	$T_A = 25^\circ\text{C}$ (Note 1a)	3.8	
T_J, T_{STG}	Operating and Storage Junction Temperature Range		-55 to +175	$^\circ\text{C}$

Thermal Characteristics

$R_{\theta JC}$	Thermal Resistance, Junction to Case	(Note 1)	0.6	$^\circ\text{C/W}$
$R_{\theta JA}$	Thermal Resistance, Junction to Ambient	(Note 1a)	40	

Package Marking and Ordering Information

Device Marking	Device	Package	Reel Size	Tape Width	Quantity
FDB0190N807L	FDB0190N807L	D2-PAK-7L	330 mm	24 mm	800 units

Electrical Characteristics $T_J = 25\text{ }^\circ\text{C}$ unless otherwise noted.

Symbol	Parameter	Test Conditions	Min.	Typ.	Max.	Units
--------	-----------	-----------------	------	------	------	-------

Off Characteristics

BV_{DSS}	Drain to Source Breakdown Voltage	$I_D = 250\text{ }\mu\text{A}, V_{GS} = 0\text{ V}$	80			V
$\frac{\Delta BV_{DSS}}{\Delta T_J}$	Breakdown Voltage Temperature Coefficient	$I_D = 250\text{ }\mu\text{A}$, referenced to $25\text{ }^\circ\text{C}$		34		mV/ $^\circ\text{C}$
I_{DSS}	Zero Gate Voltage Drain Current	$V_{DS} = 64\text{ V}, V_{GS} = 0\text{ V}$			1	μA
I_{GSS}	Gate to Source Leakage Current	$V_{GS} = \pm 20\text{ V}, V_{DS} = 0\text{ V}$			± 100	nA

On Characteristics

$V_{GS(th)}$	Gate to Source Threshold Voltage	$V_{GS} = V_{DS}, I_D = 250\text{ }\mu\text{A}$	2	2.9	4	V
$\frac{\Delta V_{GS(th)}}{\Delta T_J}$	Gate to Source Threshold Voltage Temperature Coefficient	$I_D = 250\text{ }\mu\text{A}$, referenced to $25\text{ }^\circ\text{C}$		-13		mV/ $^\circ\text{C}$
$r_{DS(on)}$	Static Drain to Source On Resistance	$V_{GS} = 10\text{ V}, I_D = 34\text{ A}$		1.3	1.7	m Ω
		$V_{GS} = 8\text{ V}, I_D = 31\text{ A}$		1.5	2	
		$V_{GS} = 10\text{ V}, I_D = 34\text{ A}, T_J = 150\text{ }^\circ\text{C}$		2.3	4.3	
g_{FS}	Forward Transconductance	$V_{DS} = 10\text{ V}, I_D = 34\text{ A}$		133		S

Dynamic Characteristics

C_{iss}	Input Capacitance	$V_{DS} = 40\text{ V}, V_{GS} = 0\text{ V}, f = 1\text{ MHz}$		13650	19110	pF
C_{oss}	Output Capacitance			1990	2790	pF
C_{rss}	Reverse Transfer Capacitance			235	330	pF
R_g	Gate Resistance			2.9		Ω

Switching Characteristics

$t_{d(on)}$	Turn-On Delay Time	$V_{DD} = 40\text{ V}, I_D = 34\text{ A}, V_{GS} = 10\text{ V}, R_{GEN} = 6\text{ }\Omega$		60	96	ns
t_r	Rise Time			78	125	ns
$t_{d(off)}$	Turn-Off Delay Time			98	157	ns
t_f	Fall Time			50	80	ns
Q_g	Total Gate Charge			178	249	nC
Q_{gs}	Gate to Source Gate Charge	$V_{DD} = 40\text{ V}, I_D = 34\text{ A}, V_{GS} = 10\text{ V}$		60		nC
Q_{gd}	Gate to Drain "Miller" Charge			32		nC

Drain-Source Diode Characteristics

I_S	Maximum Continuous Drain to Source Diode Forward Current			270	A	
I_{SM}	Maximum Pulsed Drain to Source Diode Forward Current			1440	A	
V_{SD}	Source to Drain Diode Forward Voltage	$V_{GS} = 0\text{ V}, I_S = 34\text{ A}$ (Note 2)		0.8	1.2	V
t_{rr}	Reverse Recovery Time	$I_F = 34\text{ A}, di/dt = 100\text{ A}/\mu\text{s}$		89	142	ns
Q_{rr}	Reverse Recovery Charge			103	165	nC

Notes:

1. $R_{\theta JA}$ is the sum of the junction-to-case and case-to-ambient thermal resistance where the case thermal reference is defined as the solder mounting surface of the drain pins. $R_{\theta JC}$ is guaranteed by design while $R_{\theta CA}$ is determined by the user's board design.

- a) $40\text{ }^\circ\text{C}/\text{W}$ when mounted on a 1 in^2 pad of 2 oz copper.
 b) $62.5\text{ }^\circ\text{C}/\text{W}$ when mounted on a minimum pad of 2 oz copper.

2. Pulse Test: Pulse Width < 300 μs , Duty cycle < 2.0 %.

3. E_{AS} of 777 mJ is based on starting $T_J = 25\text{ }^\circ\text{C}$, $L = 0.3\text{ mH}$, $I_{AS} = 72\text{ A}$, $V_{DD} = 72\text{ V}$, $V_{GS} = 10\text{ V}$. 100% test at $L = 0.1\text{ mH}$, $I_{AS} = 104\text{ A}$.

4. Pulsed I_D please refer to Figure "Forward Bias Safe Operating Area" for more details.

5. Computed continuous current limited to Max Junction Temperature only, actual continuous current will be limited by thermal & electro-mechanical application board design.

Typical Characteristics $T_J = 25\text{ }^\circ\text{C}$ unless otherwise noted.

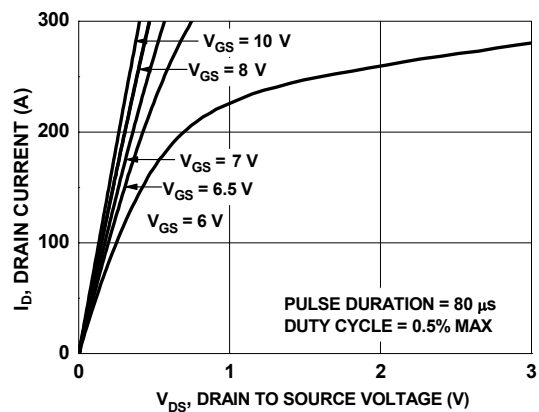

Figure 1. On Region Characteristics

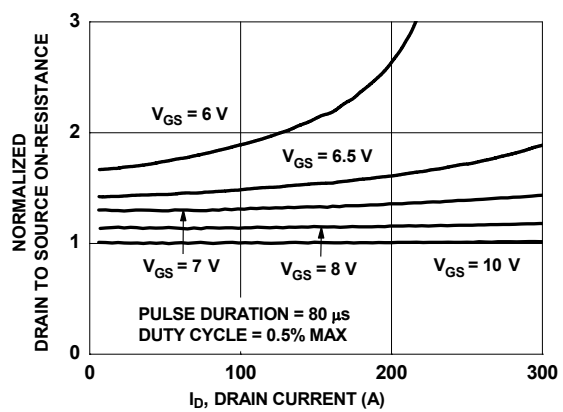

Figure 2. Normalized On-Resistance vs. Drain Current and Gate Voltage

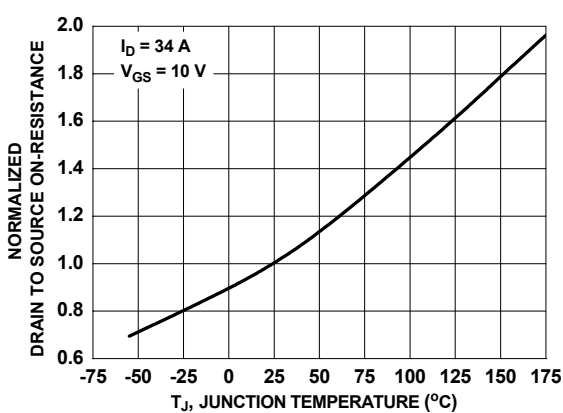

Figure 3. Normalized On Resistance vs. Junction Temperature

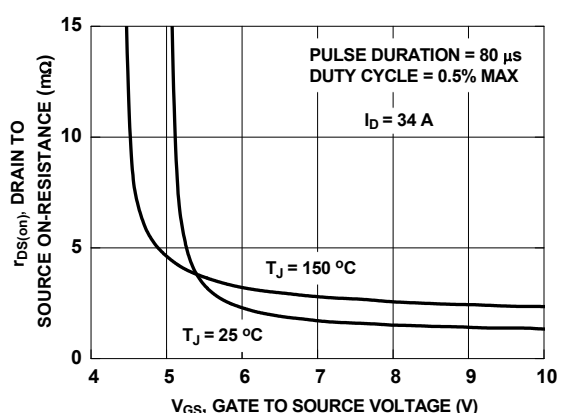

Figure 4. On-Resistance vs. Gate to Source Voltage

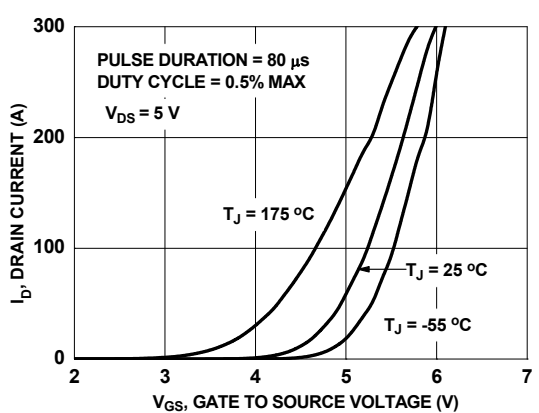

Figure 5. Transfer Characteristics

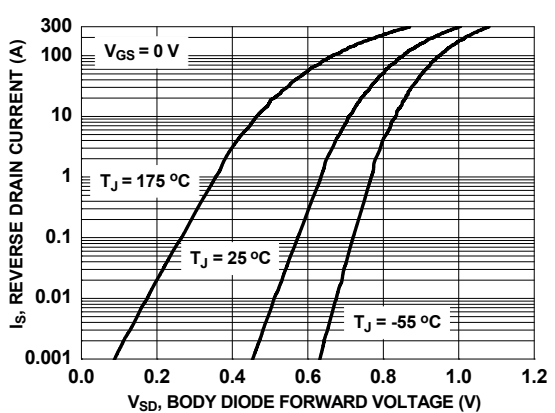

Figure 6. Source to Drain Diode Forward Voltage vs. Source Current

Typical Characteristics $T_J = 25^\circ\text{C}$ unless otherwise noted.

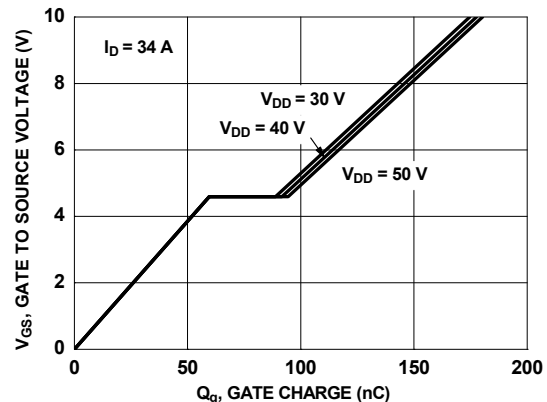

Figure 7. Gate Charge Characteristics

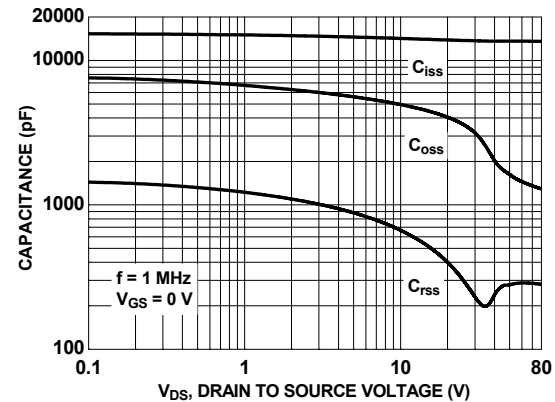

Figure 8. Capacitance vs. Drain to Source Voltage

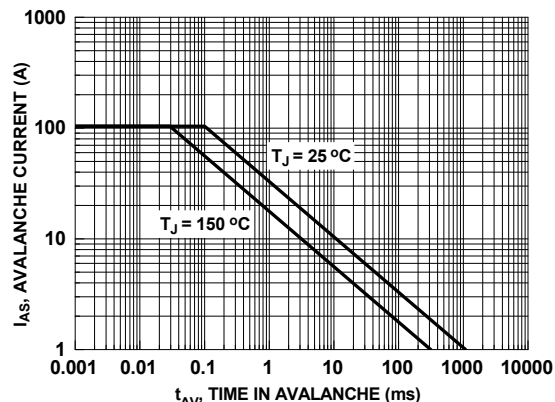

Figure 9. Unclamped Inductive Switching Capability

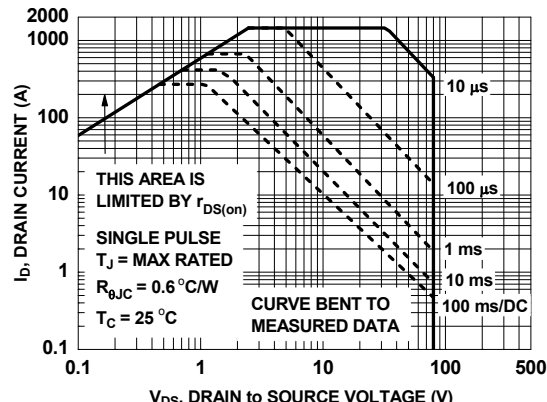

Figure 10. Forward Bias Safe Operating Area

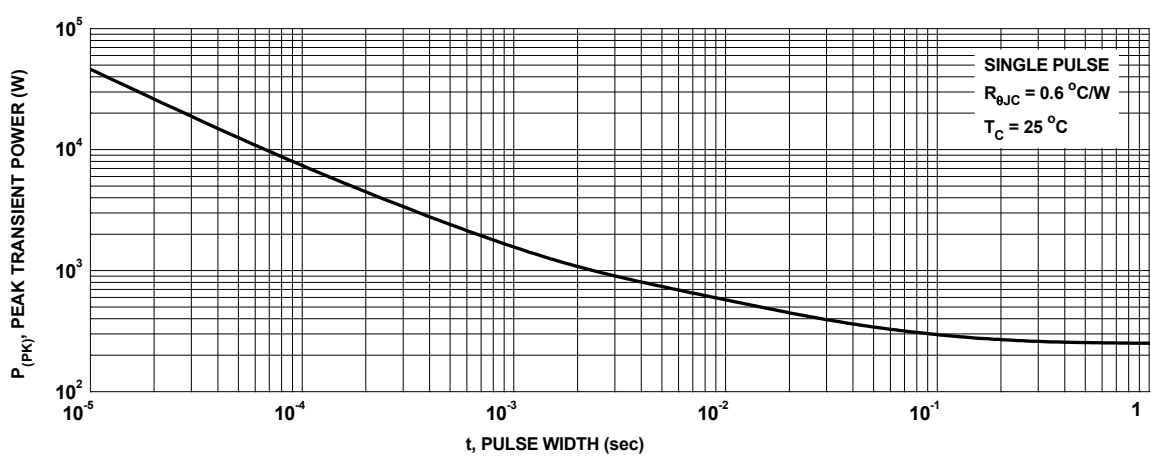

Figure 11. Single Pulse Maximum Power Dissipation

Typical Characteristics $T_J = 25\text{ }^\circ\text{C}$ unless otherwise noted.

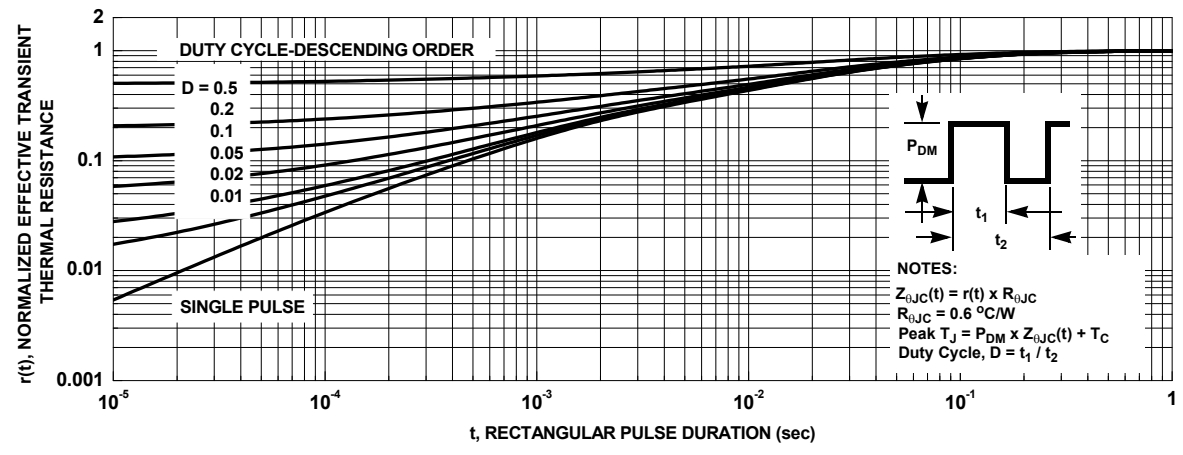
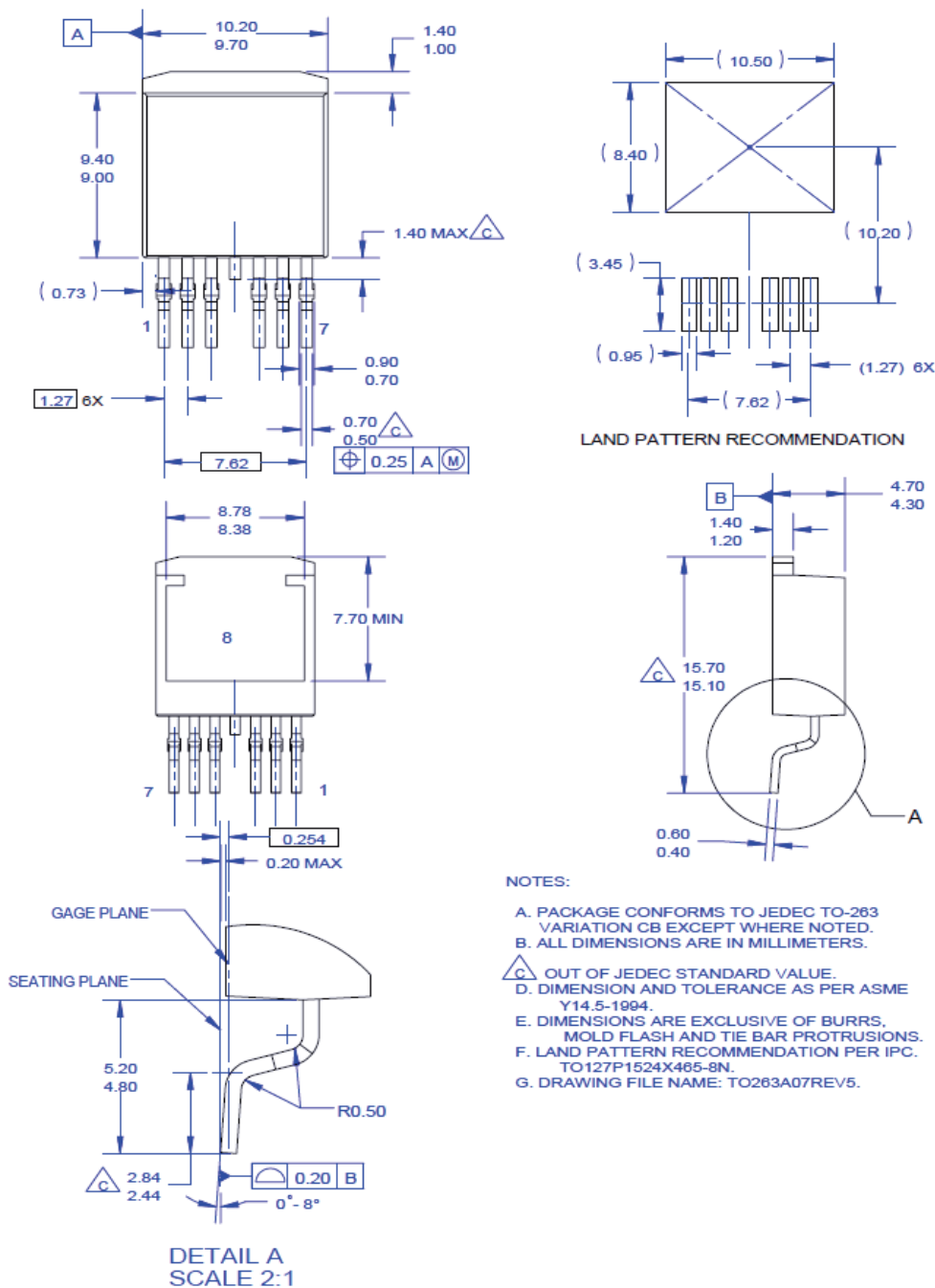

Figure 12. Junction-to-Case Transient Thermal Response Curve

Dimensional Outline and Pad Layout







Package drawings are provided as a service to customers considering Fairchild components. Drawings may change in any manner without notice. Please note the revision and/or date on the drawing and contact a Fairchild Semiconductor representative to verify or obtain the most recent revision. Package specifications do not expand the terms of Fairchild's worldwide terms and conditions, specifically the warranty therein, which covers Fairchild products.

Always visit Fairchild Semiconductor's online packaging area for the most recent package drawings.



TRADEMARKS

The following includes registered and unregistered trademarks and service marks, owned by Fairchild Semiconductor and/or its global subsidiaries, and is not intended to be an exhaustive list of all such trademarks.

- | | | | |
|---|---|---|---|
| AccuPower™ | F-PFS™ | OPTOPLANAR® |  |
| AttitudeEngine™ | FRFET® |  | TinyBoost® |
| Awinda® | Global Power ResourceSM | Power Supply WebDesigner™ | TinyBuck® |
| AX-CAP®* | GreenBridge™ | PowerTrench® | TinyCalc™ |
| BitSiC™ | Green FPS™ | PowerXS™ | TinyLogic® |
| Build it Now™ | Green FPS™ e-Series™ | Programmable Active Droop™ | TINYOPTO™ |
| CorePLUS™ | Gmax™ | QFET® | TinyPower™ |
| CorePOWER™ | GTO™ | QS™ | TinyPWM™ |
| CROSSVOLT™ | IntelliMAX™ | Quiet Series™ | TinyWire™ |
| CTL™ | ISOPLANAR™ | RapidConfigure™ | TranSiC™ |
| Current Transfer Logic™ | Marking Small Speakers Sound Louder and Better™ |  | TriFault Detect™ |
| DEUXPEED® | MegaBuck™ | Saving our world, 1mW/W/kW at a time™ | TRUECURRENT®* |
| Dual Cool™ | MICROCOUPLER™ | SignalWise™ | μSerDes™ |
| EcoSPARK® | MicroFET™ | SmartMax™ |  |
| EfficientMax™ | MicroPak™ | SMART START™ | UHC® |
| ESBC™ | MicroPak2™ | Solutions for Your Success™ | Ultra FRFET™ |
|  | MillerDrive™ | SPM® | UniFET™ |
| Fairchild® | MotionMax™ | STEALTH™ | VCX™ |
| Fairchild Semiconductor® | MotionGrid® | SuperFET® | VisualMax™ |
| FACT Quiet Series™ | MTi® | SuperSOT™-3 | VoltagePlus™ |
| FACT® | MTx® | SuperSOT™-6 | XS™ |
| FastvCore™ | MVN® | SuperSOT™-8 | Xsens™ |
| FETBench™ | mWSaver® | SupreMOS® | 仙童® |
| FPS™ | OptoHiT™ | SyncFET™ | |
| | OPTOLOGIC® | Sync-Lock™ | |

*Trademarks of System General Corporation, used under license by Fairchild Semiconductor.

DISCLAIMER

FAIRCHILD SEMICONDUCTOR RESERVES THE RIGHT TO MAKE CHANGES WITHOUT FURTHER NOTICE TO ANY PRODUCTS HEREIN TO IMPROVE RELIABILITY, FUNCTION, OR DESIGN. TO OBTAIN THE LATEST, MOST UP-TO-DATE DATASHEET AND PRODUCT INFORMATION, VISIT OUR WEBSITE AT [HTTP://WWW.FAIRCHILDEMI.COM](http://www.fairchildsemi.com). FAIRCHILD DOES NOT ASSUME ANY LIABILITY ARISING OUT OF THE APPLICATION OR USE OF ANY PRODUCT OR CIRCUIT DESCRIBED HEREIN; NEITHER DOES IT CONVEY ANY LICENSE UNDER ITS PATENT RIGHTS, NOR THE RIGHTS OF OTHERS. THESE SPECIFICATIONS DO NOT EXPAND THE TERMS OF FAIRCHILD'S WORLDWIDE TERMS AND CONDITIONS, SPECIFICALLY THE WARRANTY THEREIN, WHICH COVERS THESE PRODUCTS.

AUTHORIZED USE

Unless otherwise specified in this data sheet, this product is a standard commercial product and is not intended for use in applications that require extraordinary levels of quality and reliability. This product may not be used in the following applications, unless specifically approved in writing by a Fairchild officer: (1) automotive or other transportation, (2) military/aerospace, (3) any safety critical application – including life critical medical equipment – where the failure of the Fairchild product reasonably would be expected to result in personal injury, death or property damage. Customer's use of this product is subject to agreement of this Authorized Use policy. In the event of an unauthorized use of Fairchild's product, Fairchild accepts no liability in the event of product failure. In other respects, this product shall be subject to Fairchild's Worldwide Terms and Conditions of Sale, unless a separate agreement has been signed by both Parties.

ANTI-COUNTERFEITING POLICY

Fairchild Semiconductor Corporation's Anti-Counterfeiting Policy. Fairchild's Anti-Counterfeiting Policy is also stated on our external website, www.fairchildsemi.com, under Terms of Use

Counterfeiting of semiconductor parts is a growing problem in the industry. All manufacturers of semiconductor products are experiencing counterfeiting of their parts. Customers who inadvertently purchase counterfeit parts experience many problems such as loss of brand reputation, substandard performance, failed applications, and increased cost of production and manufacturing delays. Fairchild is taking strong measures to protect ourselves and our customers from the proliferation of counterfeit parts. Fairchild strongly encourages customers to purchase Fairchild parts either directly from Fairchild or from Authorized Fairchild Distributors who are listed by country on our web page cited above. Products customers buy either from Fairchild directly or from Authorized Fairchild Distributors are genuine parts, have full traceability, meet Fairchild's quality standards for handling and storage and provide access to Fairchild's full range of up-to-date technical and product information. Fairchild and our Authorized Distributors will stand behind all warranties and will appropriately address and warranty issues that may arise. Fairchild will not provide any warranty coverage or other assistance for parts bought from Unauthorized Sources. Fairchild is committed to combat this global problem and encourage our customers to do their part in stopping this practice by buying direct or from authorized distributors.

PRODUCT STATUS DEFINITIONS

Definition of Terms

Datasheet Identification	Product Status	Definition
Advance Information	Formative / In Design	Datasheet contains the design specifications for product development. Specifications may change in any manner without notice.
Preliminary	First Production	Datasheet contains preliminary data; supplementary data will be published at a later date. Fairchild Semiconductor reserves the right to make changes at any time without notice to improve design.
No Identification Needed	Full Production	Datasheet contains final specifications. Fairchild Semiconductor reserves the right to make changes at any time without notice to improve the design.
Obsolete	Not In Production	Datasheet contains specifications on a product that is discontinued by Fairchild Semiconductor. The datasheet is for reference information only.

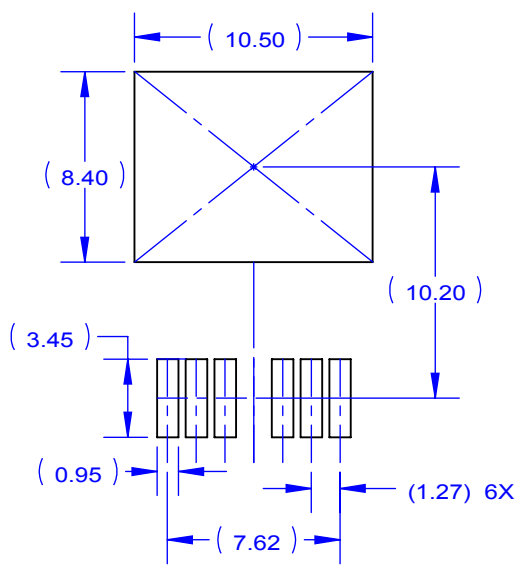
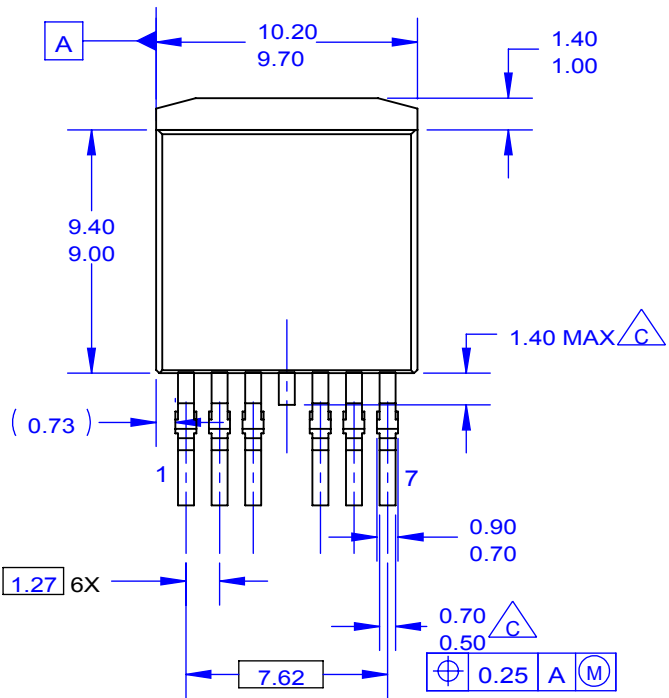

LAND PATTERN RECOMMENDATION

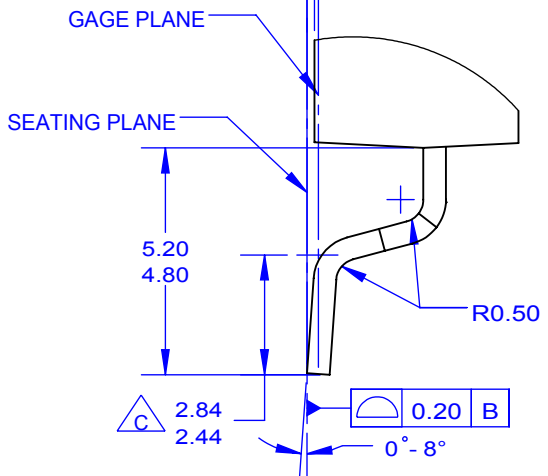
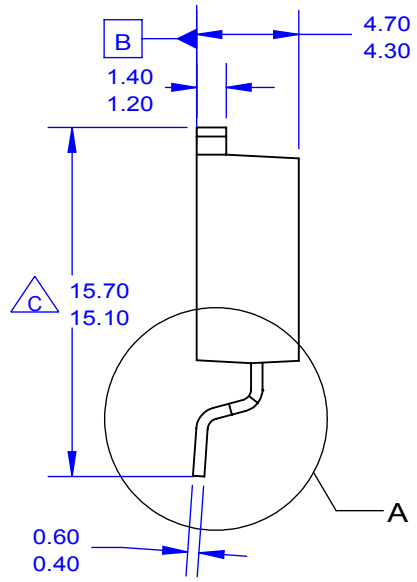
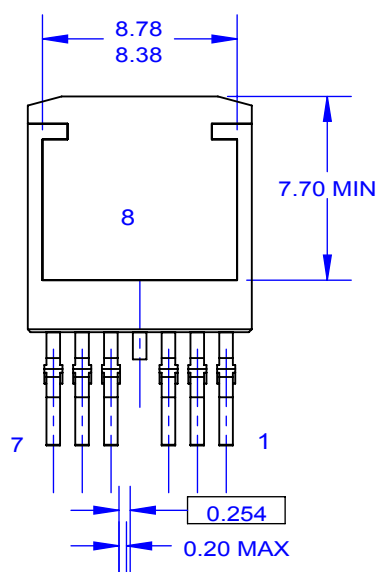

DETAIL A
SCALE 2:1

NOTES:

- A. PACKAGE CONFORMS TO JEDEC TO-263 VARIATION CB EXCEPT WHERE NOTED.
- B. ALL DIMENSIONS ARE IN MILLIMETERS.
- C. OUT OF JEDEC STANDARD VALUE.
- D. DIMENSION AND TOLERANCE AS PER ASME Y14.5-1994.
- E. DIMENSIONS ARE EXCLUSIVE OF BURRS, MOLD FLASH AND TIE BAR PROTRUSIONS.
- F. LAND PATTERN RECOMMENDATION PER IPC TO127P1524X465-8N.
- G. DRAWING FILE NAME: TO263A07REV5.



TRADEMARKS

The following includes registered and unregistered trademarks and service marks, owned by Fairchild Semiconductor and/or its global subsidiaries, and is not intended to be an exhaustive list of all such trademarks.

- | | | | |
|--------------------------|--|---------------------------------------|------------------|
| AccuPower™ | F-PFS™ | OPTOPLANAR® | SYSTEM GENERAL® |
| AttitudeEngine™ | FRFET® | Power Supply WebDesigner™ | TinyBoost® |
| Awinda® | Global Power Resource SM | PowerTrench® | TinyBuck® |
| AX-CAP®* | GreenBridge™ | PowerXS™ | TinyCalc™ |
| BitSiC™ | Green FPS™ | Programmable Active Droop™ | TinyLogic® |
| Build it Now™ | Green FPS™ e-Series™ | QFET® | TINYOPTO™ |
| CorePLUS™ | Gmax™ | QS™ | TinyPower™ |
| CorePOWER™ | GTO™ | Quiet Series™ | TinyPWM™ |
| CROSSVOL™ | IntelliMAX™ | RapidConfigure™ | TinyWire™ |
| CTL™ | ISOPLANAR™ | Saving our world, 1mW/W/kW at a time™ | TranSiC™ |
| Current Transfer Logic™ | Making Small Speakers Sound Louder and Better™ | SignalWise™ | TriFault Detect™ |
| DEUXPEED® | MegaBuck™ | SmartMax™ | TRUECURRENT®* |
| Dual Cool™ | MICROCOUPLER™ | SMART START™ | μSerDes™ |
| EcoSPARK® | MicroFET™ | Solutions for Your Success™ | UHC® |
| EfficientMax™ | MicroPak™ | SPM® | Ultra FRFET™ |
| ESBC™ | MicroPak2™ | STEALTH™ | UniFET™ |
| F [®] | MillerDrive™ | SuperFET® | Vcx™ |
| Fairchild® | MotionMax™ | SuperSOT™-3 | VisualMax™ |
| Fairchild Semiconductor® | MotionGrid® | SuperSOT™-6 | VoltagePlus™ |
| FACT Quiet Series™ | MTi® | SuperSOT™-8 | Xs™ |
| FACT® | MTx® | SupreMOS® | Xsens™ |
| FastvCore™ | MVN® | SyncFET™ | 仙童® |
| FETBench™ | mWSaver® | Sync-Lock™ | |
| FPS™ | OptoHiT™ | | |
| | OPTOLOGIC® | | |

* Trademarks of System General Corporation, used under license by Fairchild Semiconductor.

DISCLAIMER

FAIRCHILD SEMICONDUCTOR RESERVES THE RIGHT TO MAKE CHANGES WITHOUT FURTHER NOTICE TO ANY PRODUCTS HEREIN TO IMPROVE RELIABILITY, FUNCTION, OR DESIGN. TO OBTAIN THE LATEST, MOST UP-TO-DATE DATASHEET AND PRODUCT INFORMATION, VISIT OUR WEBSITE AT [HTTP://WWW.FAIRCHILDSEMI.COM](http://www.fairchildsemi.com). FAIRCHILD DOES NOT ASSUME ANY LIABILITY ARISING OUT OF THE APPLICATION OR USE OF ANY PRODUCT OR CIRCUIT DESCRIBED HEREIN; NEITHER DOES IT CONVEY ANY LICENSE UNDER ITS PATENT RIGHTS, NOR THE RIGHTS OF OTHERS. THESE SPECIFICATIONS DO NOT EXPAND THE TERMS OF FAIRCHILD'S WORLDWIDE TERMS AND CONDITIONS, SPECIFICALLY THE WARRANTY THEREIN, WHICH COVERS THESE PRODUCTS.

AUTHORIZED USE

Unless otherwise specified in this data sheet, this product is a standard commercial product and is not intended for use in applications that require extraordinary levels of quality and reliability. This product may not be used in the following applications, unless specifically approved in writing by a Fairchild officer: (1) automotive or other transportation, (2) military/aerospace, (3) any safety critical application – including life critical medical equipment – where the failure of the Fairchild product reasonably would be expected to result in personal injury, death or property damage. Customer's use of this product is subject to agreement of this Authorized Use policy. In the event of an unauthorized use of Fairchild's product, Fairchild accepts no liability in the event of product failure. In other respects, this product shall be subject to Fairchild's Worldwide Terms and Conditions of Sale, unless a separate agreement has been signed by both Parties.

ANTI-COUNTERFEITING POLICY

Fairchild Semiconductor Corporation's Anti-Counterfeiting Policy. Fairchild's Anti-Counterfeiting Policy is also stated on our external website, www.fairchildsemi.com, under Terms of Use

Counterfeiting of semiconductor parts is a growing problem in the industry. All manufacturers of semiconductor products are experiencing counterfeiting of their parts. Customers who inadvertently purchase counterfeit parts experience many problems such as loss of brand reputation, substandard performance, failed applications, and increased cost of production and manufacturing delays. Fairchild is taking strong measures to protect ourselves and our customers from the proliferation of counterfeit parts. Fairchild strongly encourages customers to purchase Fairchild parts either directly from Fairchild or from Authorized Fairchild Distributors who are listed by country on our web page cited above. Products customers buy either from Fairchild directly or from Authorized Fairchild Distributors are genuine parts, have full traceability, meet Fairchild's quality standards for handling and storage and provide access to Fairchild's full range of up-to-date technical and product information. Fairchild and our Authorized Distributors will stand behind all warranties and will appropriately address any warranty issues that may arise. Fairchild will not provide any warranty coverage or other assistance for parts bought from Unauthorized Sources. Fairchild is committed to combat this global problem and encourage our customers to do their part in stopping this practice by buying direct or from authorized distributors.

PRODUCT STATUS DEFINITIONS

Definition of Terms

Datasheet Identification	Product Status	Definition
Advance Information	Formative / In Design	Datasheet contains the design specifications for product development. Specifications may change in any manner without notice.
Preliminary	First Production	Datasheet contains preliminary data; supplementary data will be published at a later date. Fairchild Semiconductor reserves the right to make changes at any time without notice to improve design.
No Identification Needed	Full Production	Datasheet contains final specifications. Fairchild Semiconductor reserves the right to make changes at any time without notice to improve the design.
Obsolete	Not In Production	Datasheet contains specifications on a product that is discontinued by Fairchild Semiconductor. The datasheet is for reference information only.

Rev. I77

Mouser Electronics

Authorized Distributor

Click to View Pricing, Inventory, Delivery & Lifecycle Information:

[Fairchild Semiconductor:](#)

[FDB0190N807L](#)