



May 2014

FQA6N90C_F109

N-Channel QFET[®] MOSFET 900 V, 6 A, 2.3 Ω

Features

- 6 A, 900 V, $R_{DS(on)} = 2.3 \Omega$ (Max.) @ $V_{GS} = 10 \text{ V}$, $I_D = 3 \text{ A}$
- Low Gate Charge (Typ. 30 nC)
- Low Crss (Typ. 11 pF)
- 100% Avalanche Tested
- RoHS Compliant

Description

This N-Channel enhancement mode power MOSFET is produced using Fairchild Semiconductor's proprietary planar stripe and DMOS technology. This advanced MOSFET technology has been especially tailored to reduce on-state resistance, and to provide superior switching performance and high avalanche energy strength. These devices are suitable for switched mode power supplies, active power factor correction (PFC), and electronic lamp ballasts.

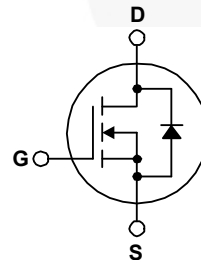
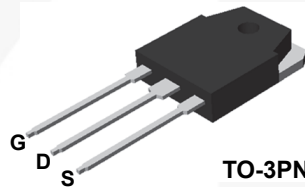

Absolute Maximum Ratings T_C = 25°C unless otherwise noted.

Symbol	Parameter	FQA6N90C_F109	Unit
V_{DSS}	Drain-Source Voltage	900	V
I_D	Drain Current - Continuous ($T_C = 25^\circ\text{C}$) - Continuous ($T_C = 100^\circ\text{C}$)	6.0	A
		3.87	A
I_{DM}	Drain Current - Pulsed (Note 1)	24.0	A
V_{GSS}	Gate-Source Voltage	± 30	V
E_{AS}	Single Pulsed Avalanche Energy (Note 2)	650	mJ
I_{AR}	Avalanche Current (Note 1)	6.0	A
E_{AR}	Repetitive Avalanche Energy (Note 1)	19.8	mJ
dv/dt	Peak Diode Recovery dv/dt (Note 3)	4.0	V/ns
P_D	Power Dissipation ($T_C = 25^\circ\text{C}$)	198	W
	- Derate above 25°C	1.59	W/°C
T_J, T_{STG}	Operating and Storage Temperature Range	-55 to +150	°C
T_L	Maximum lead temperature for soldering purposes, 1/8" from case for 5 seconds	300	°C

Thermal Characteristics

Symbol	Parameter	FQA6N90C_F109	Unit
$R_{\theta JC}$	Thermal Resistance, Junction-to-Case, Max.	0.63	°C/W
$R_{\theta CS}$	Thermal Resistance, Case-to-Sink, Typ.	0.24	°C/W
$R_{\theta JA}$	Thermal Resistance, Junction-to-Ambient, Max	40	°C/W

Package Marking and Ordering Information

Part Number	Top Mark	Package	Packing Method	Reel Size	Tape Width	Quantity
FQA6N90C_F109	FQA6N90C	TO-3PN	Tube	N/A	N/A	30 units

Electrical Characteristics T_C = 25°C unless otherwise noted.

Symbol	Parameter	Test Conditions	Min.	Typ.	Max.	Unit	
Off Characteristics							
BV _{DSS}	Drain-Source Breakdown Voltage	V _{GS} = 0 V, I _D = 250 μA	900	--	--	V	
ΔBV _{DSS} /ΔT _J	Breakdown Voltage Temperature Coefficient	I _D = 250 μA, Referenced to 25°C	--	1.07	--	V/°C	
I _{DSS}	Zero Gate Voltage Drain Current	V _{DS} = 900 V, V _{GS} = 0 V	--	--	10	μA	
		V _{DS} = 720 V, T _C = 125°C	--	--	100	μA	
I _{GSSF}	Gate-Body Leakage Current, Forward	V _{GS} = 30 V, V _{DS} = 0 V	--	--	100	nA	
I _{GSSR}	Gate-Body Leakage Current, Reverse	V _{GS} = -30 V, V _{DS} = 0 V	--	--	-100	nA	
On Characteristics							
V _{GS(th)}	Gate Threshold Voltage	V _{DS} = V _{GS} , I _D = 250 μA	3.0	--	5.0	V	
R _{DS(on)}	Static Drain-Source On-Resistance	V _{GS} = 10 V, I _D = 3.0 A	--	1.93	2.3	Ω	
g _{FS}	Forward Transconductance	V _{DS} = 50 V, I _D = 3.0 A	--	5.5	--	S	
Dynamic Characteristics							
C _{iss}	Input Capacitance	V _{DS} = 25 V, V _{GS} = 0 V, f = 1.0 MHz	--	1360	1770	pF	
C _{oss}	Output Capacitance		--	110	145	pF	
C _{rss}	Reverse Transfer Capacitance		--	11	15	pF	
Switching Characteristics							
t _{d(on)}	Turn-On Delay Time	V _{DD} = 450 V, I _D = 6.0A, R _G = 25 Ω	--	35	80	ns	
t _r	Turn-On Rise Time		--	90	190	ns	
t _{d(off)}	Turn-Off Delay Time		(Note 4)	--	55	120	ns
t _f	Turn-Off Fall Time		(Note 4)	--	60	130	ns
Q _g	Total Gate Charge	V _{DS} = 720 V, I _D = 6.0A, V _{GS} = 10 V	--	30	40	nC	
Q _{gs}	Gate-Source Charge		(Note 4)	--	9.0	--	nC
Q _{gd}	Gate-Drain Charge		(Note 4)	--	12	--	nC
Drain-Source Diode Characteristics and Maximum Ratings							
I _S	Maximum Continuous Drain-Source Diode Forward Current		--	--	6.0	A	
I _{SM}	Maximum Pulsed Drain-Source Diode Forward Current		--	--	24	A	
V _{SD}	Drain-Source Diode Forward Voltage	V _{GS} = 0 V, I _S = 6.0 A	--	--	1.4	V	
t _{rr}	Reverse Recovery Time	V _{GS} = 0 V, I _S = 6.0 A, di _F / dt = 100 A/μs	--	630	--	ns	
Q _{rr}	Reverse Recovery Charge		--	6.9	--	μC	

NOTES:

1. Repetitive rating: pulse-width limited by maximum junction temperature.
2. L = 34 mH, I_{AS} = 6 A, V_{DD} = 50 V, R_G = 25 Ω, starting T_J = 25°C.
3. I_{SD} ≤ 6 A, di/dt ≤ 200 A/μs, V_{DD} ≤ BV_{DSS}, starting T_J = 25°C.
4. Essentially independent of operating temperature typical characteristics.

Typical Performance Characteristics

Figure 1. On-Region Characteristics

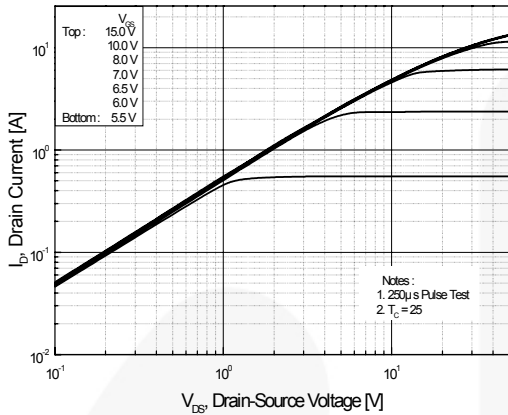

Figure 2. Transfer Characteristics

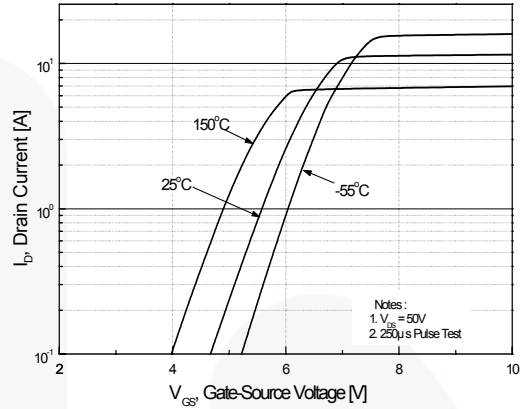

Figure 3. On-Resistance Variation vs. Drain Current and Gate Voltage

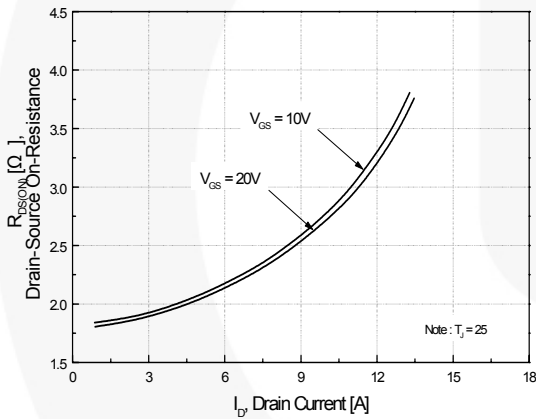

Figure 4. Body Diode Forward Voltage Variation vs. Source Current and Temperature

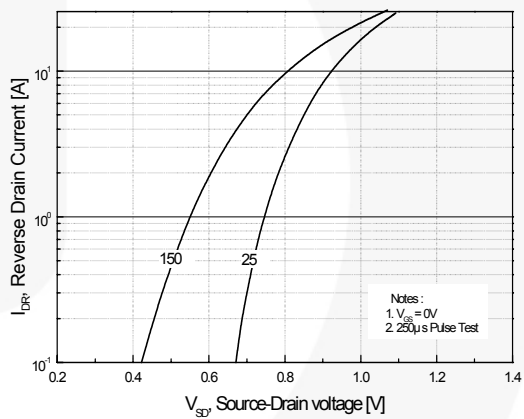

Figure 5. Capacitance Characteristics

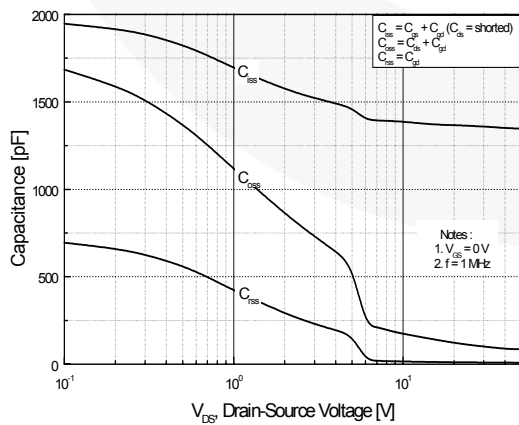
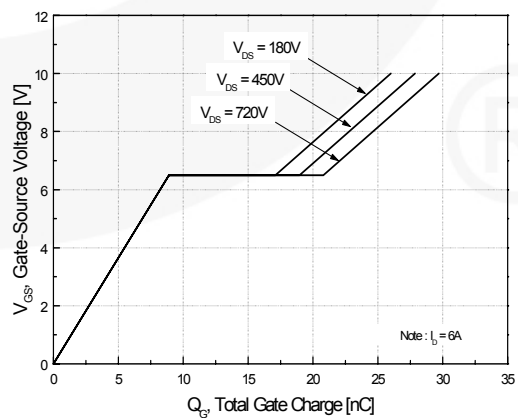

Figure 6. Gate Charge Characteristics



Typical Performance Characteristics (Continued)

Figure 7. Breakdown Voltage Variation vs. Temperature

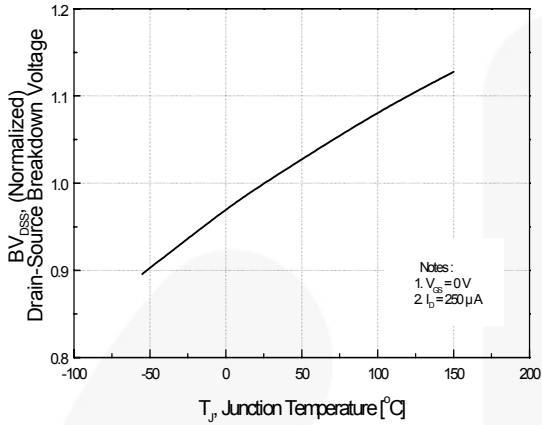

Figure 8. On-Resistance Variation vs. Temperature

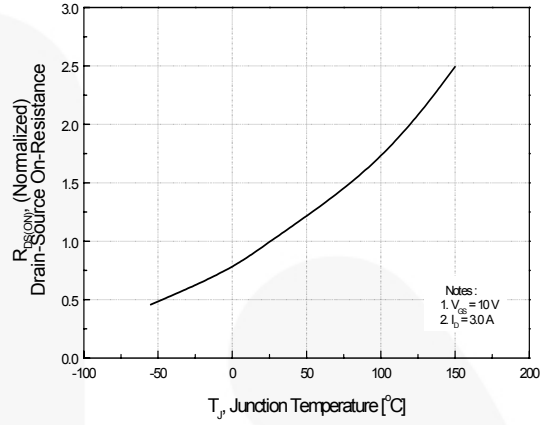

Figure 9. Maximum Safe Operating Area

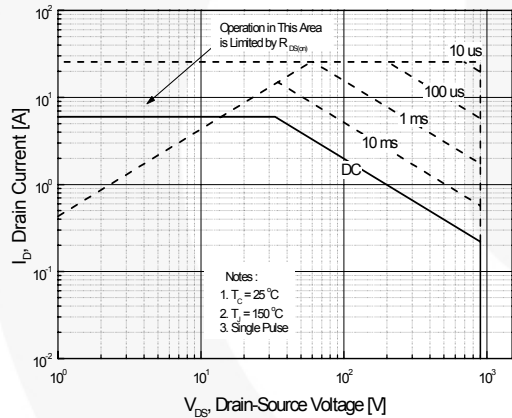

Figure 10. Maximum Drain Current vs. Case Temperature

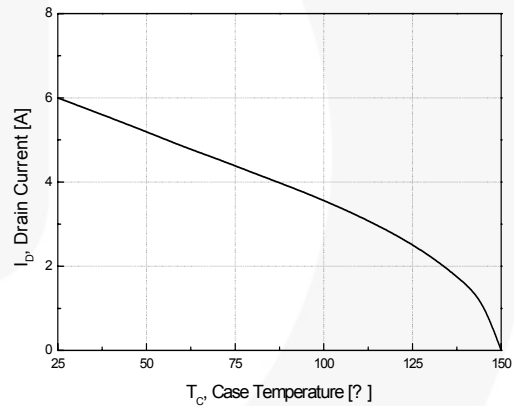
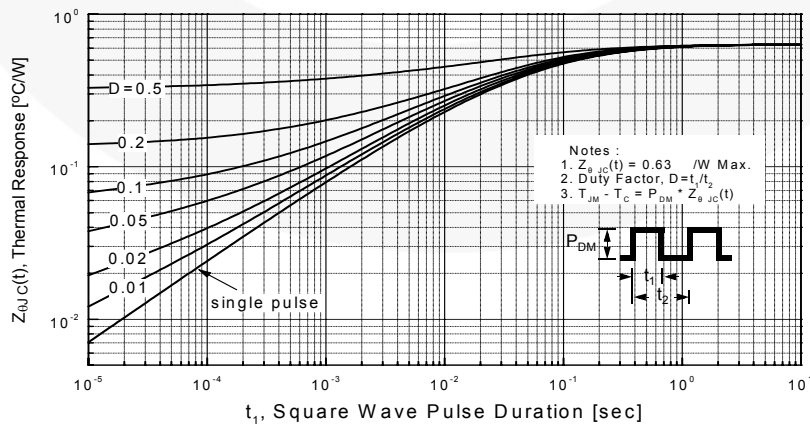

Figure 11. Transient Thermal Response Curve



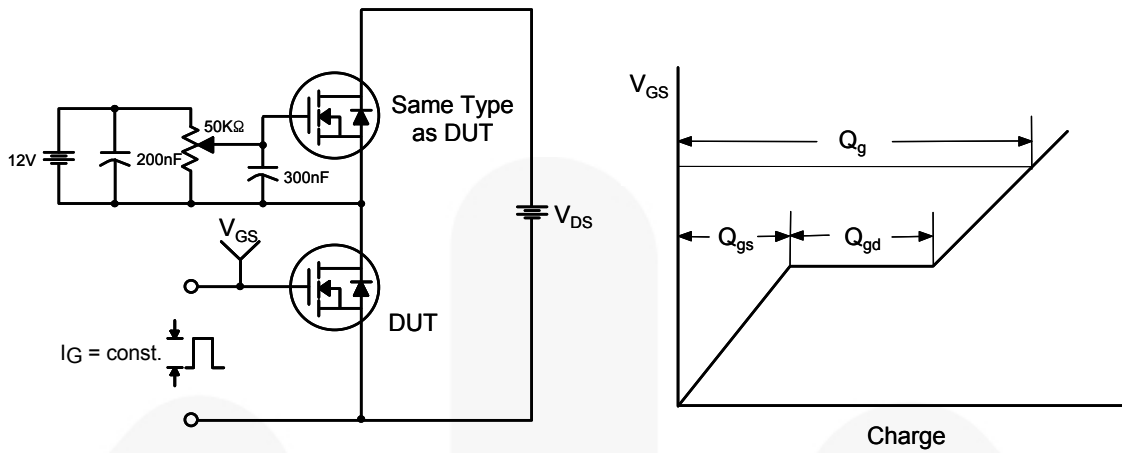

Figure 12. Gate Charge Test Circuit & Waveform

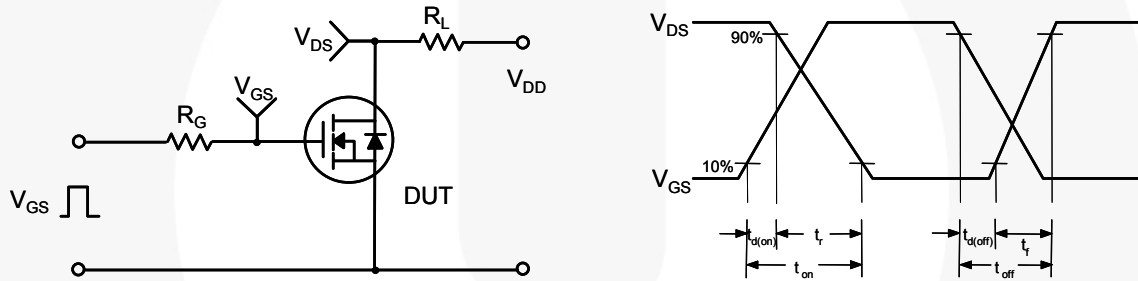

Figure 13. Resistive Switching Test Circuit & Waveforms

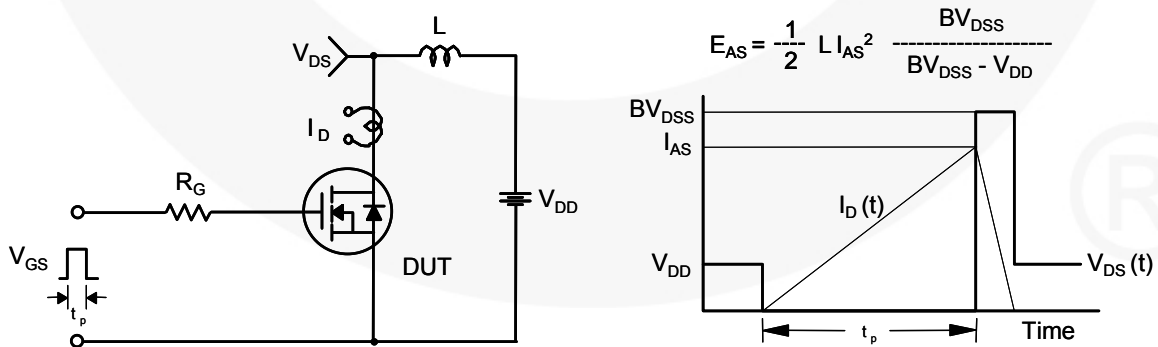

Figure 14. Unclamped Inductive Switching Test Circuit & Waveforms

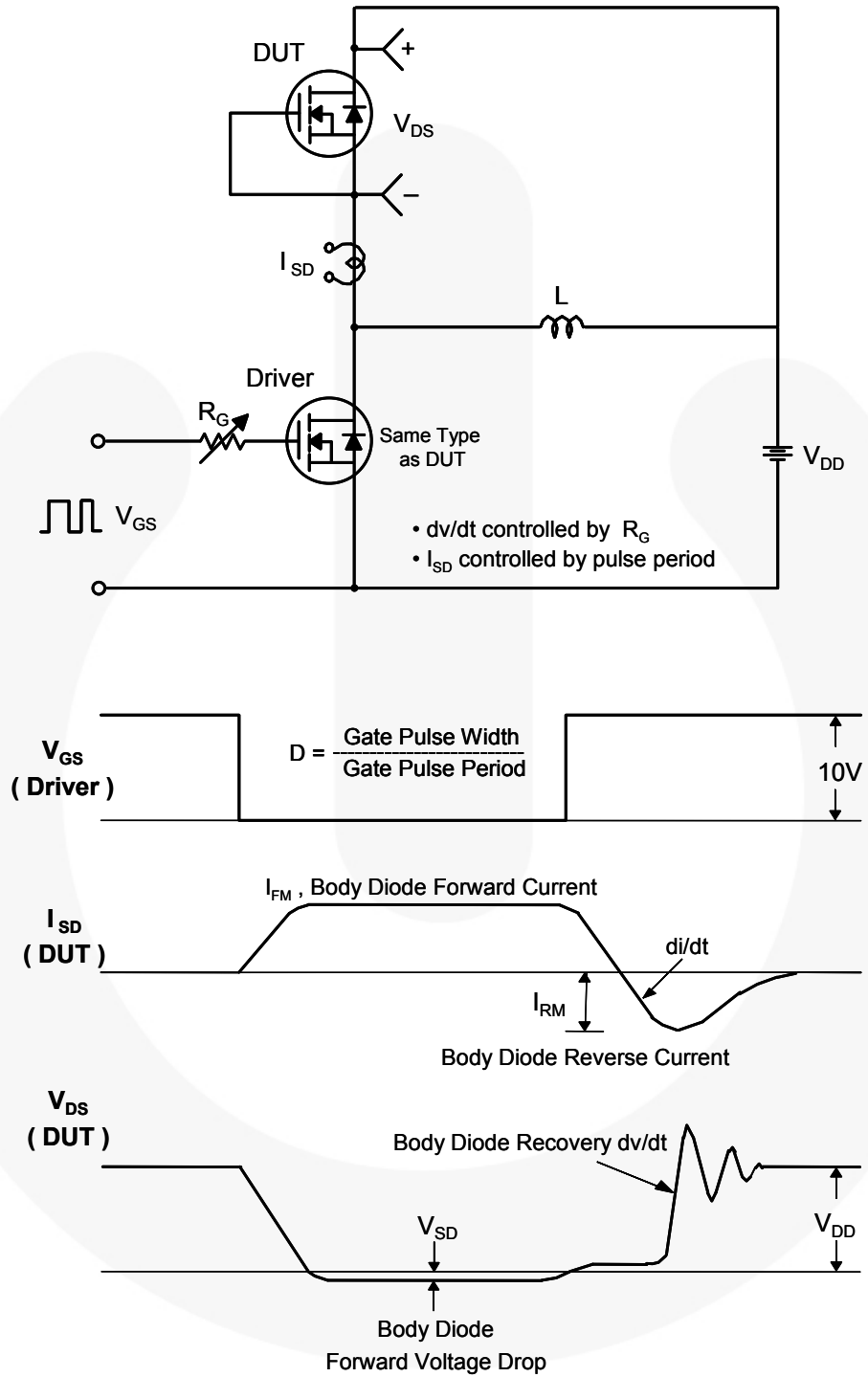
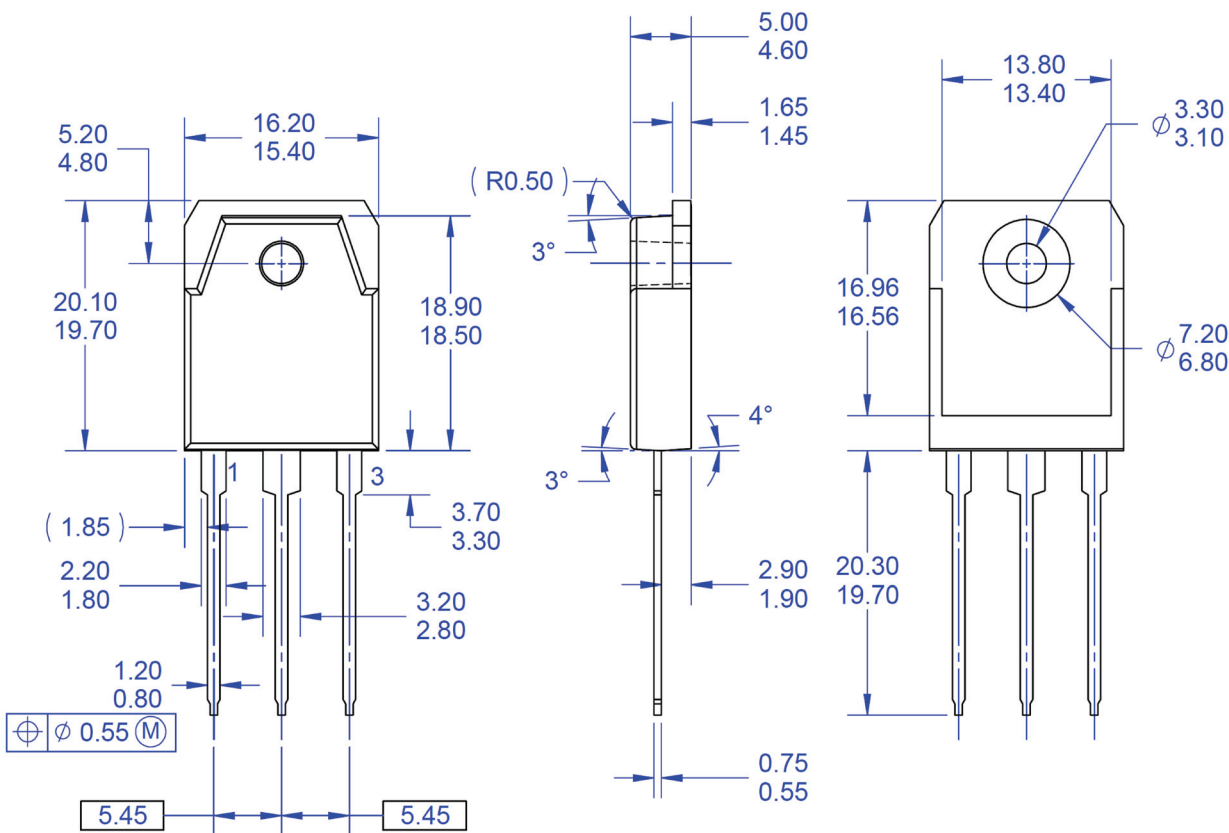

Figure 15. Peak Diode Recovery dv/dt Test Circuit & Waveforms

Mechanical Dimensions



NOTES: UNLESS OTHERWISE SPECIFIED

- A) THIS PACKAGE CONFORMS TO EIAJ SC-65 PACKAGING STANDARD.
- B) ALL DIMENSIONS ARE IN MILLIMETERS.
- C) DIMENSION AND TOLERANCING PER ASME14.5-2009.
- D) DIMENSIONS ARE EXCLUSIVE OF BURRS, MOLD FLASH, AND TIE BAR EXTRUSIONS.
- E) DRAWING FILE NAME: TO3PN03AREV1.
- F) FAIRCHILD SEMICONDUCTOR.

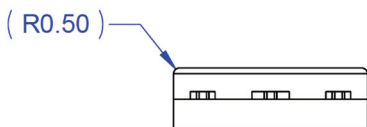

Figure 16. TO3PN, 3-Lead, Plastic, EIAJ SC-65

Package drawings are provided as a service to customers considering Fairchild components. Drawings may change in any manner without notice. Please note the revision and/or date on the drawing and contact a Fairchild Semiconductor representative to verify or obtain the most recent revision. Package specifications do not expand the terms of Fairchild's worldwide terms and conditions, specifically the warranty therein, which covers Fairchild products.





Always visit Fairchild Semiconductor's online packaging area for the most recent package drawings:

http://www.fairchildsemi.com/package/packageDetails.html?id=PN_TT3PN-003



TRADEMARKS

The following includes registered and unregistered trademarks and service marks, owned by Fairchild Semiconductor and/or its global subsidiaries, and is not intended to be an exhaustive list of all such trademarks.

- | | | | |
|---|---|---|---|
| AccuPower™ | F-PFS™ |  ® |  SYSTEM® |
| AX-CAP®* | FRFET® | PowerTrench® | TinyBoost® |
| BitSiC™ | Global Power ResourceSM | PowerXS™ | TinyBuck® |
| Build it Now™ | GreenBridge™ | Programmable Active Droop™ | TinyCalc™ |
| CorePLUS™ | Green FPS™ | QFET® | TinyLogic® |
| CorePOWER™ | Green FPS™ e-Series™ | QS™ | TINYOPTO™ |
| CROSSVOL™ | Gmax™ | Quiet Series™ | TinyPower™ |
| CTL™ | GTO™ | RapidConfigure™ | TinyPWM™ |
| Current Transfer Logic™ | IntelliMAX™ |  ™ | TinyWire™ |
| DEUXPEED® | ISOPLANAR™ | Saving our world, 1mW/W/kW at a time™ | TranSiC™ |
| Dual Cool™ | Marking Small Speakers Sound Louder and Better™ | SignalWise™ | TriFault Detect™ |
| EcoSPARK® | MegaBuck™ | SmartMax™ | TRUECURRENT®* |
| EfficientMax™ | MICROCOUPLER™ | SMART START™ | µSerDes™ |
| ESBC™ | MicroFET™ | Solutions for Your Success™ |  SerDes™ |
|  ® | MicroPak™ | SPM® | UHC® |
| Fairchild® | MicroPak2™ | STEALTH™ | Ultra FRFET™ |
| Fairchild Semiconductor® | MillerDrive™ | SuperFET® | UniFET™ |
| FACT Quiet Series™ | MotionMax™ | SuperSOT™-3 | VCX™ |
| FACT® | mWSaver® | SuperSOT™-6 | VisualMax™ |
| FAST® | OptoHit™ | SuperSOT™-8 | VoltagePlus™ |
| FastvCore™ | OPTOLOGIC® | SupreMOS® | XS™ |
| FETBench™ | OPTOPLANAR® | SyncFET™ | 仙童™ |
| FPS™ | | Sync-Lock™ | |

*Trademarks of System General Corporation, used under license by Fairchild Semiconductor.

DISCLAIMER

FAIRCHILD SEMICONDUCTOR RESERVES THE RIGHT TO MAKE CHANGES WITHOUT FURTHER NOTICE TO ANY PRODUCTS HEREIN TO IMPROVE RELIABILITY, FUNCTION, OR DESIGN. FAIRCHILD DOES NOT ASSUME ANY LIABILITY ARISING OUT OF THE APPLICATION OR USE OF ANY PRODUCT OR CIRCUIT DESCRIBED HEREIN; NEITHER DOES IT CONVEY ANY LICENSE UNDER ITS PATENT RIGHTS, NOR THE RIGHTS OF OTHERS. THESE SPECIFICATIONS DO NOT EXPAND THE TERMS OF FAIRCHILD'S WORLDWIDE TERMS AND CONDITIONS, SPECIFICALLY THE WARRANTY THEREIN, WHICH COVERS THESE PRODUCTS.

LIFE SUPPORT POLICY

FAIRCHILD'S PRODUCTS ARE NOT AUTHORIZED FOR USE AS CRITICAL COMPONENTS IN LIFE SUPPORT DEVICES OR SYSTEMS WITHOUT THE EXPRESS WRITTEN APPROVAL OF FAIRCHILD SEMICONDUCTOR CORPORATION.

As used here in:

- Life support devices or systems are devices or systems which, (a) are intended for surgical implant into the body or (b) support or sustain life, and (c) whose failure to perform when properly used in accordance with instructions for use provided in the labeling, can be reasonably expected to result in a significant injury of the user.
- A critical component in any component of a life support, device, or system whose failure to perform can be reasonably expected to cause the failure of the life support device or system, or to affect its safety or effectiveness.

ANTI-COUNTERFEITING POLICY

Fairchild Semiconductor Corporation's Anti-Counterfeiting Policy. Fairchild's Anti-Counterfeiting Policy is also stated on our external website, www.fairchildsemi.com, under Sales Support. Counterfeiting of semiconductor parts is a growing problem in the industry. All manufactures of semiconductor products are experiencing counterfeiting of their parts. Customers who inadvertently purchase counterfeit parts experience many problems such as loss of brand reputation, substandard performance, failed application, and increased cost of production and manufacturing delays. Fairchild is taking strong measures to protect ourselves and our customers from the proliferation of counterfeit parts. Fairchild strongly encourages customers to purchase Fairchild parts either directly from Fairchild or from Authorized Fairchild Distributors who are listed by country on our web page cited above. Products customers buy either from Fairchild directly or from Authorized Fairchild Distributors are genuine parts, have full traceability, meet Fairchild's quality standards for handling and storage and provide access to Fairchild's full range of up-to-date technical and product information. Fairchild and our Authorized Distributors will stand behind all warranties and will appropriately address and warranty issues that may arise. Fairchild will not provide any warranty coverage or other assistance for parts bought from Unauthorized Sources. Fairchild is committed to combat this global problem and encourage our customers to do their part in stopping this practice by buying direct or from authorized distributors.

PRODUCT STATUS DEFINITIONS

Definition of Terms

Datasheet Identification	Product Status	Definition
Advance Information	Formative / In Design	Datasheet contains the design specifications for product development. Specifications may change in any manner without notice.
Preliminary	First Production	Datasheet contains preliminary data; supplementary data will be published at a later date. Fairchild Semiconductor reserves the right to make changes at any time without notice to improve design.
No Identification Needed	Full Production	Datasheet contains final specifications. Fairchild Semiconductor reserves the right to make changes at any time without notice to improve the design.
Obsolete	Not In Production	Datasheet contains specifications on a product that is discontinued by Fairchild Semiconductor. The datasheet is for reference information only.

Rev. I68

Mouser Electronics

Authorized Distributor

Click to View Pricing, Inventory, Delivery & Lifecycle Information:

[Fairchild Semiconductor:](#)

[FQA6N90C_F109](#)