



July 2015

FQA90N15_F109

N-Channel QFET[®] MOSFET

150 V, 90 A, 18 mΩ

Features

- $R_{DS(on)} = 18\text{ m}\Omega$ (Max.) @ $V_{GS} = 10\text{ V}$, $I_D = 45\text{ A}$
- Low Gate Charge (Typ. 220 nC)
- Low C_{rss} (Typ. 200 pF)
- 100% Avalanche Tested
- 175°C Maximum Junction Temperature Rating

Description

These N-Channel enhancement mode power field effect transistors are produced using Fairchild's proprietary, planar stripe, DMOS technology.

This advanced technology has been especially tailored to minimize on-state resistance, provide superior switching performance, and withstand high energy pulse in the avalanche and commutation mode. These devices are well suited for low voltage applications such as audio amplifier, high efficiency switching for DC/DC converters, and DC motor control, uninterrupted power supply.

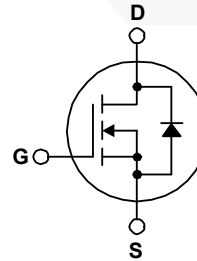
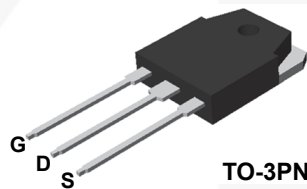

Absolute Maximum Ratings $T_C = 25^\circ\text{C}$ unless otherwise noted.

Symbol	Parameter	FQA90N15_F109	Unit
V_{DSS}	Drain-Source Voltage	150	V
I_D	Drain Current - Continuous ($T_C = 25^\circ\text{C}$) - Continuous ($T_C = 100^\circ\text{C}$)	90 63.5	A A
I_{DM}	Drain Current - Pulsed (Note 1)	360	A
V_{GSS}	Gate-Source voltage	± 25	V
E_{AS}	Single Pulsed Avalanche Energy (Note 2)	1400	mJ
I_{AR}	Avalanche Current (Note 1)	90	A
E_{AR}	Repetitive Avalanche Energy (Note 1)	37.5	mJ
dv/dt	Peak Diode Recovery dv/dt (Note 3)	6.0	V/ns
P_D	Power Dissipation ($T_C = 25^\circ\text{C}$) - Derate Above 25°C	375 2.5	W W/°C
T_J, T_{STG}	Operating and Storage Temperature Range	-55 to +175	°C
T_L	Maximum Lead Temperature for Soldering Purpose, 1/8" from Case for 5 Seconds	300	°C

Thermal Characteristics

Symbol	Parameter	FQA90N15_F109	Unit
$R_{\theta JC}$	Thermal Resistance, Junction-to-Case, Max.	0.4	°C/W
$R_{\theta CS}$	Thermal Resistance, Case-to-Sink, Typ.	0.24	°C/W
$R_{\theta JA}$	Thermal Resistance, Junction-to-Ambient, Max.	40	°C/W

Package Marking and Ordering Information

Part Number	Top Mark	Package	Packing Method	Reel Size	Tape Width	Quantity
FQA90N15_F109	FQA90N15	TO-3PN	Tube	N/A	N/A	30 units

Electrical Characteristics T_C = 25°C unless otherwise noted.

Symbol	Parameter	Conditions	Min.	Typ.	Max	Units
Off Characteristics						
BV _{DSS}	Drain-Source Breakdown Voltage	V _{GS} = 0V, I _D = 250μA	150	--	--	V
ΔBV _{DSS} / ΔT _J	Breakdown Voltage Temperature Coefficient	I _D = 250μA, Referenced to 25°C	--	0.15	--	V/°C
I _{DSS}	Zero Gate Voltage Drain Current	V _{DS} = 150V, V _{GS} = 0V V _{DS} = 120V, T _C = 150°C	--	--	1 10	μA μA
I _{GSSF}	Gate-Body Leakage Current, Forward	V _{GS} = 25V, V _{DS} = 0V	--	--	100	nA
I _{GSSR}	Gate-Body Leakage Current, Reverse	V _{GS} = -25V, V _{DS} = 0V	--	--	-100	nA
On Characteristics						
V _{GS(th)}	Gate Threshold Voltage	V _{DS} = V _{GS} , I _D = 250μA	2.0	--	4.0	V
R _{DS(on)}	Static Drain-Source On-Resistance	V _{GS} = 10V, I _D = 45A	--	0.014	0.018	Ω
g _{FS}	Forward Transconductance	V _{DS} = 40V, I _D = 45A	--	68	--	S
Dynamic Characteristics						
C _{iss}	Input Capacitance	V _{DS} = 25V, V _{GS} = 0V, f = 1.0MHz	--	6700	8700	pF
C _{oss}	Output Capacitance		--	1400	1800	pF
C _{rss}	Reverse Transfer Capacitance		--	200	260	pF
Switching Characteristics						
t _{d(on)}	Turn-On Delay Time	V _{DD} = 75V, I _D = 90A R _G = 25Ω	--	105	220	ns
t _r	Turn-On Rise Time		--	760	1500	ns
t _{d(off)}	Turn-Off Delay Time		--	470	950	ns
t _f	Turn-Off Fall Time		(Note 4)	--	410	830
Q _g	Total Gate Charge	V _{DS} = 120V, I _D = 90A V _{GS} = 10V	--	220	285	nC
Q _{gs}	Gate-Source Charge		--	43	--	nC
Q _{gd}	Gate-Drain Charge		(Note 4)	--	110	--
Drain-Source Diode Characteristics and Maximum Ratings						
I _S	Maximum Continuous Drain-Source Diode Forward Current		--	--	90	A
I _{SM}	Maximum Pulsed Drain-Source Diode Forward Current		--	--	360	A
V _{SD}	Drain-Source Diode Forward Voltage	V _{GS} = 0V, I _S = 90A	--	--	1.5	V
t _{rr}	Reverse Recovery Time	V _{GS} = 0V, I _S = 90A di/dt = 100A/μs	--	175	--	ns
Q _{rr}	Reverse Recovery Charge		--	0.97	--	μC

NOTES:

1. Repetitive rating: pulse-width limited by maximum junction temperature.
2. L = 0.29 mH, I_{AS} = 90 A, V_{DD} = 25 V, R_G = 25 Ω, starting T_J = 25°C.
3. I_{SD} ≤ 90 A, di/dt ≤ 300 A/μs, V_{DD} ≤ BV_{DSS}, starting T_J = 25°C.
4. Essentially independent of operating temperature typical characteristics.

Typical Performance Characteristics

Figure 1. On-Region Characteristics

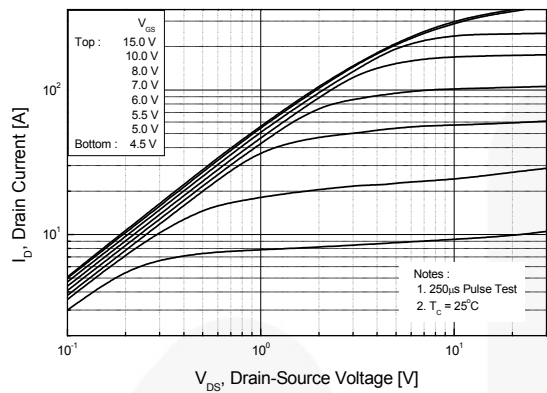

Figure 2. Transfer Characteristics

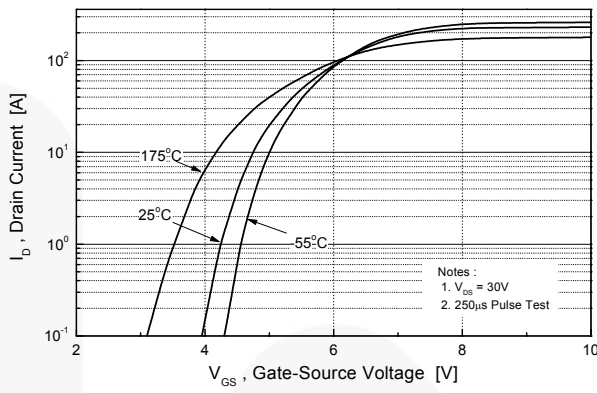

Figure 3. On-Resistance Variation vs. Drain Current and Gate Voltage

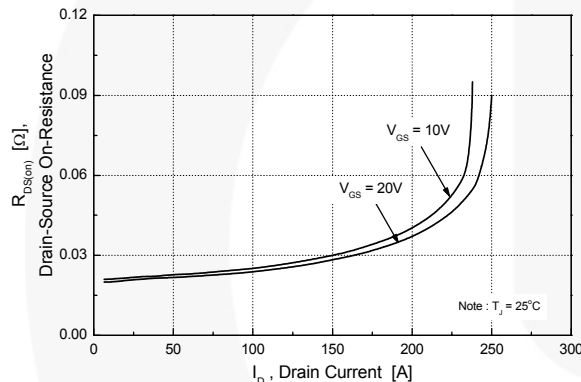

Figure 4. Body Diode Forward Voltage Variation vs. Source Current

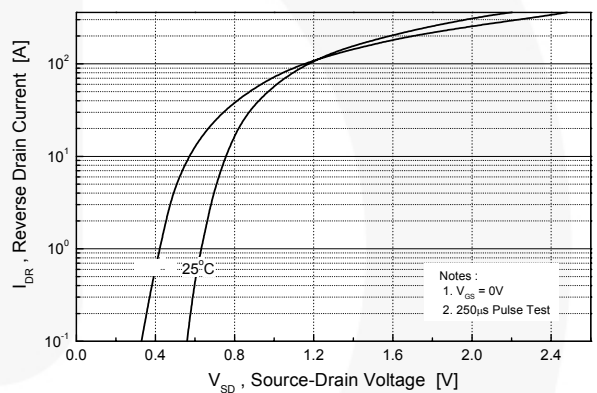

Figure 5. Capacitance Characteristics

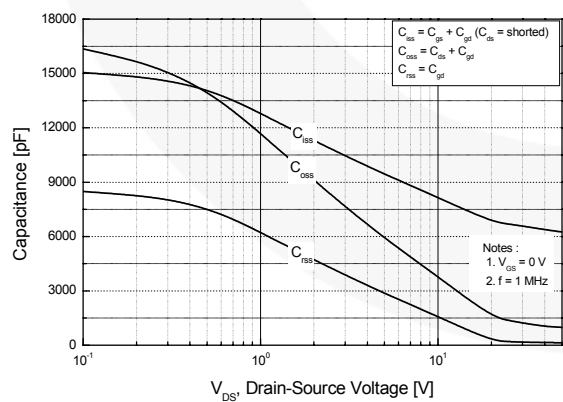
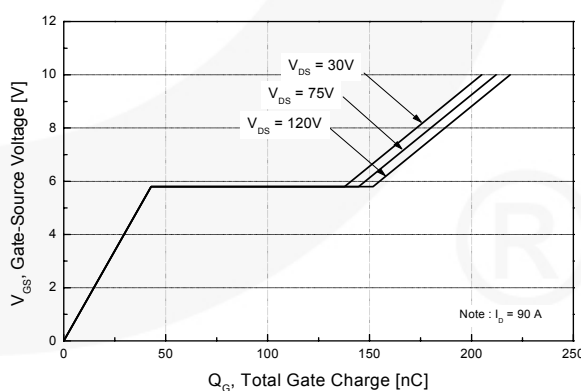

Figure 6. Gate Charge Characteristics



Typical Performance Characteristics (Continued)

Figure 7. Breakdown Voltage Variation vs. Temperature

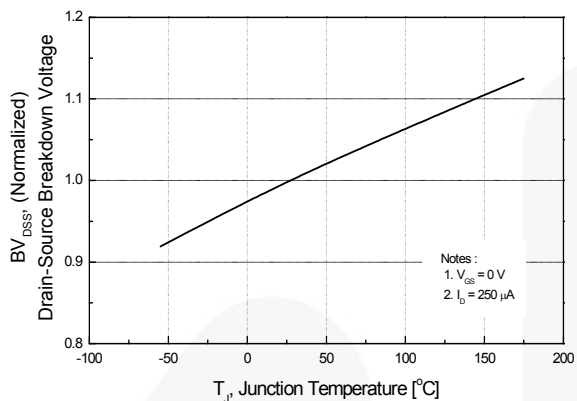

Figure 8. On-Resistance Variation vs. Temperature

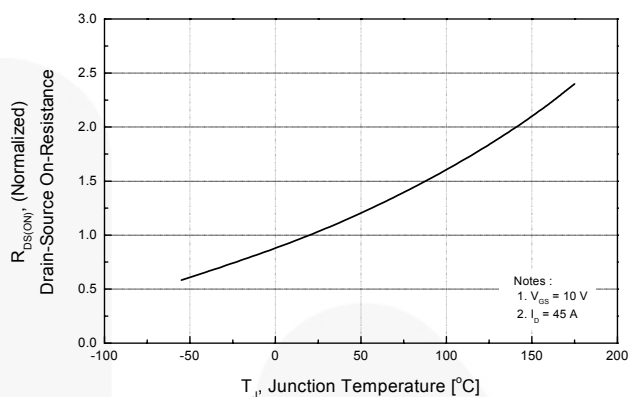

Figure 9. Maximum Safe Operating Area

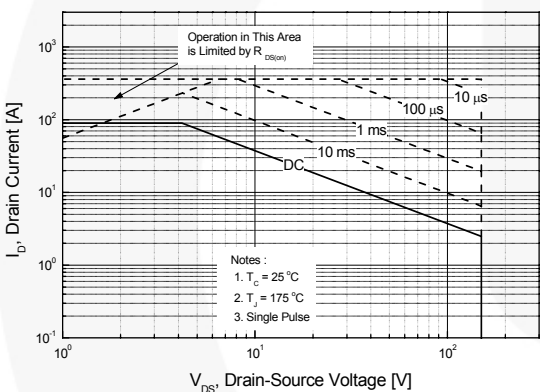

Figure 10. Maximum Drain Current vs. Case Temperature

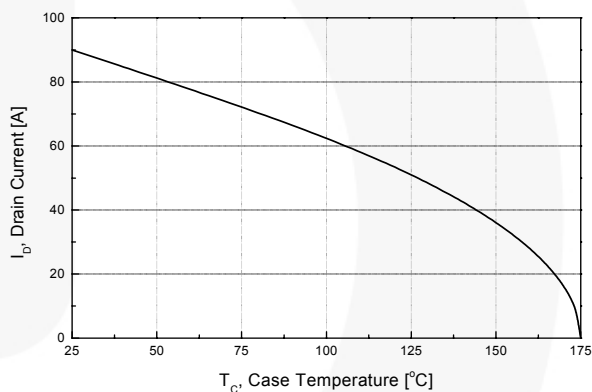
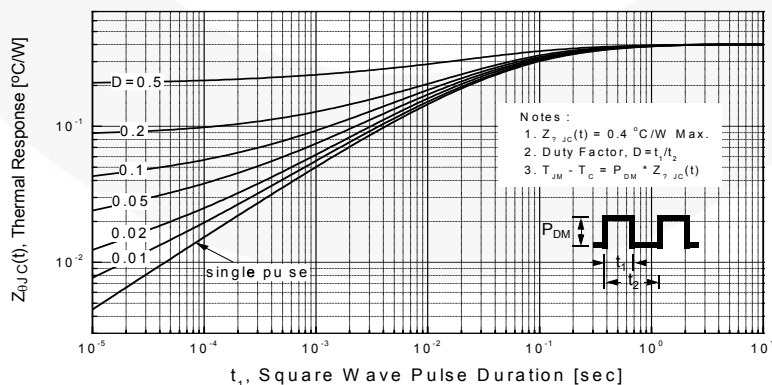

Figure 11. Transient Thermal Response Curve



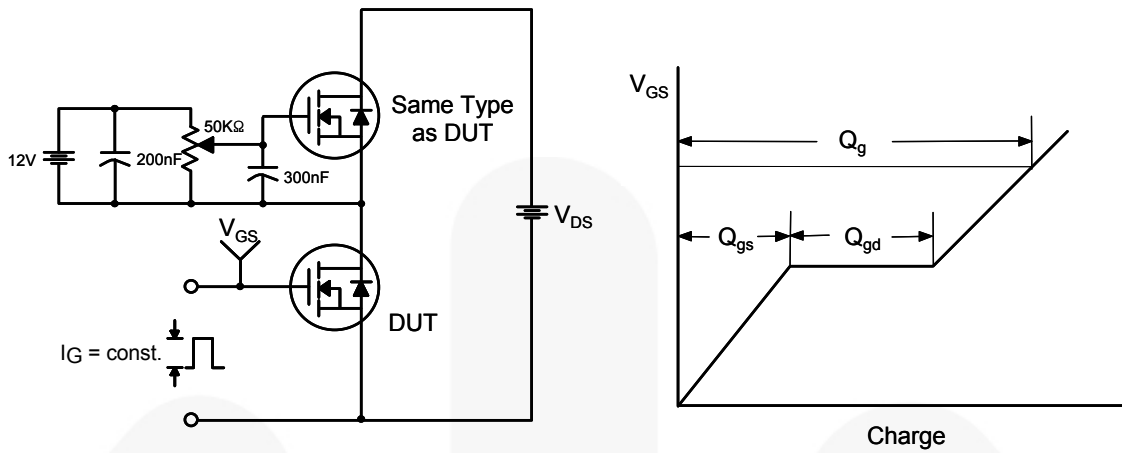

Figure 12. Gate Charge Test Circuit & Waveform

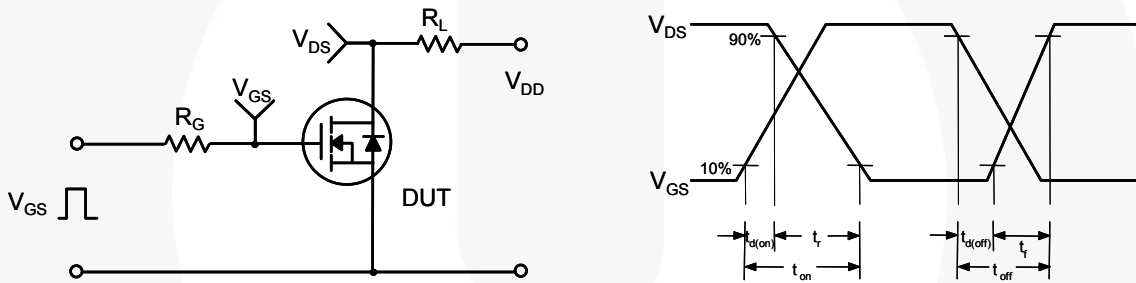

Figure 13. Resistive Switching Test Circuit & Waveforms

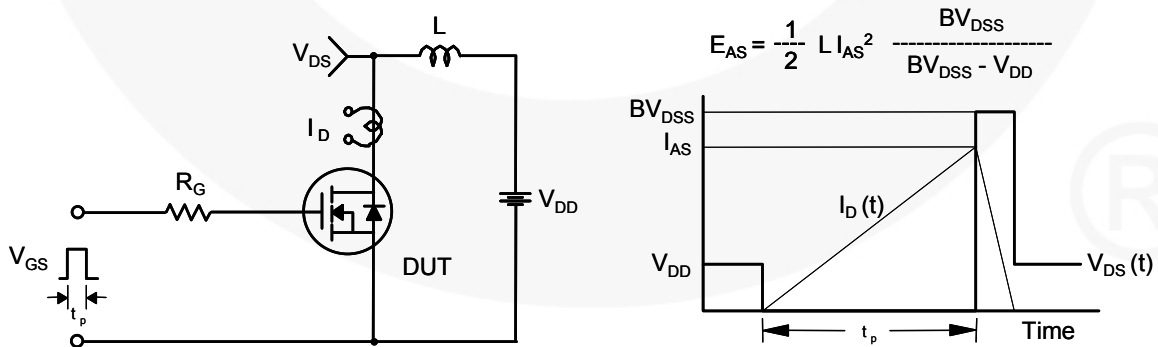

Figure 14. Unclamped Inductive Switching Test Circuit & Waveforms

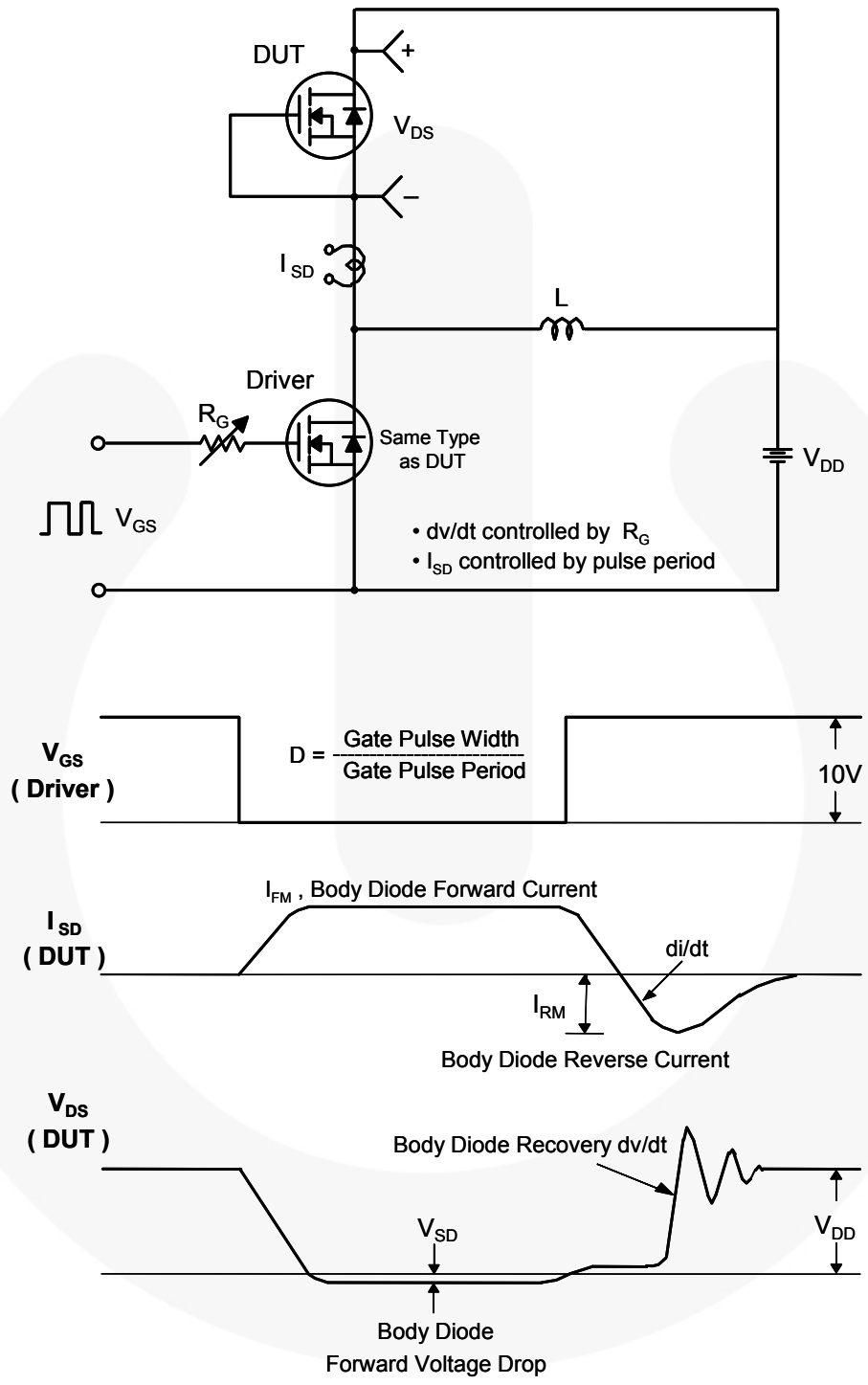
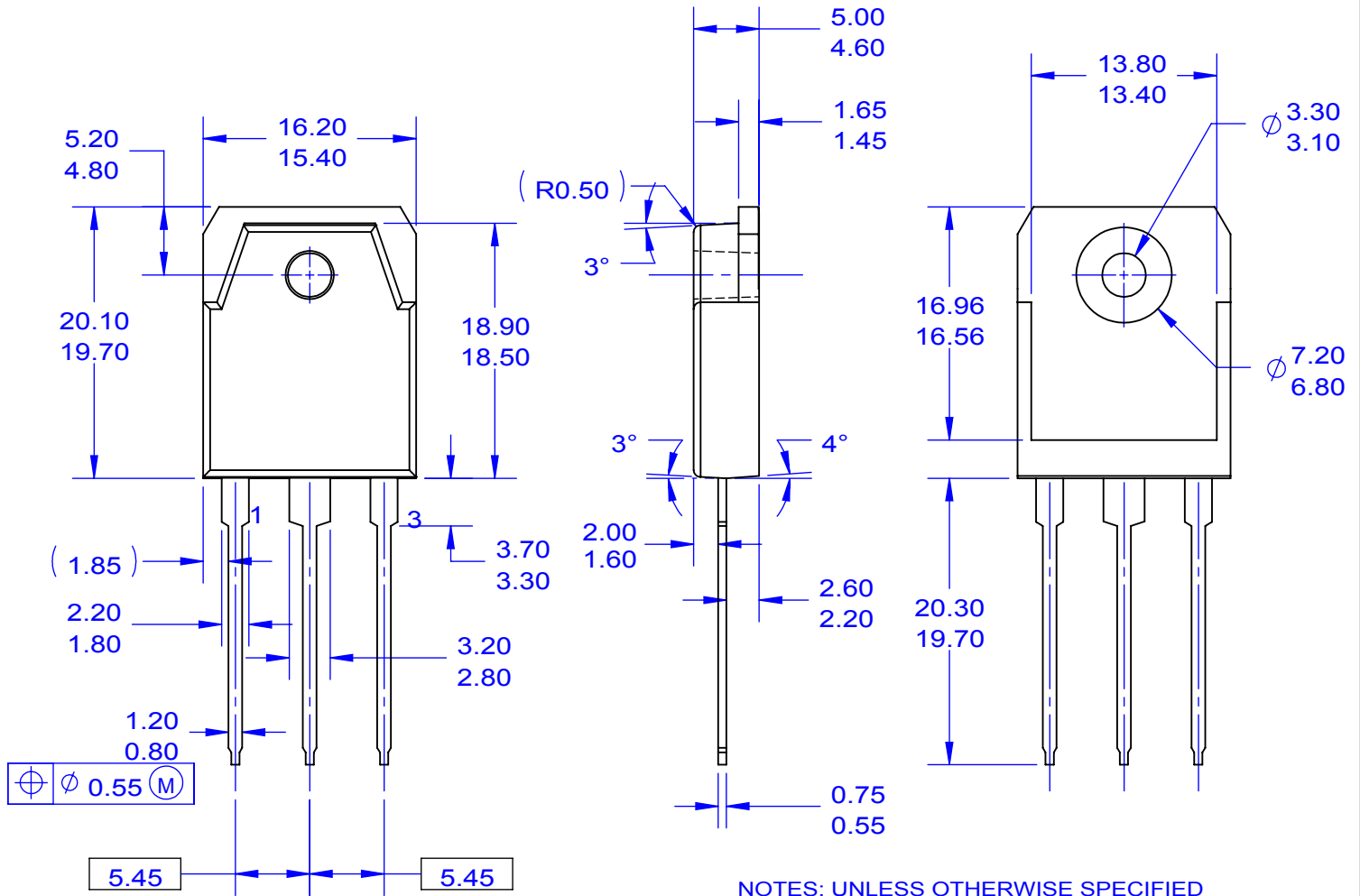
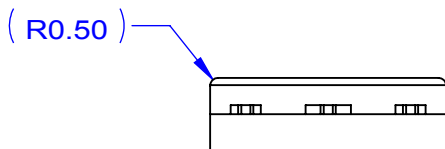

Figure 15. Peak Diode Recovery dv/dt Test Circuit & Waveforms



NOTES: UNLESS OTHERWISE SPECIFIED

- A) THIS PACKAGE CONFORMS TO EIAJ SC-65 PACKAGING STANDARD.
- B) ALL DIMENSIONS ARE IN MILLIMETERS.
- C) DIMENSION AND TOLERANCING PER ASME14.5-2009.
- D) DIMENSIONS ARE EXCLUSIVE OF BURRS, MOLD FLASH, AND TIE BAR EXTRUSIONS.
- E) DRAWING FILE NAME: TO3PN03AREV2.
- F) FAIRCHILD SEMICONDUCTOR.





TRADEMARKS

The following includes registered and unregistered trademarks and service marks, owned by Fairchild Semiconductor and/or its global subsidiaries, and is not intended to be an exhaustive list of all such trademarks.

- AccuPower™
- AttitudeEngine™
- Awinda®
- AX-CAP®*
- BitSiC™
- Build it Now™
- CorePLUS™
- CorePOWER™
- CROSSVOL™
- CTL™
- Current Transfer Logic™
- DEUXPEED®
- Dual Cool™
- EcoSPARK®
- EfficientMax™
- ESBC™
- F**™
- Fairchild®
- Fairchild Semiconductor®
- FACT Quiet Series™
- FACT®
- FastvCore™
- FETBench™
- FPS™
- F-PFS™
- FRFET®
- Global Power ResourceSM
- GreenBridge™
- Green FPS™
- Green FPS™ e-Series™
- Gmax™
- GTO™
- IntelliMAX™
- ISOPLANAR™
- Making Small Speakers Sound Louder and Better™
- MegaBuck™
- MICROCOUPLER™
- MicroFET™
- MicroPak™
- MicroPak2™
- MillerDrive™
- MotionMax™
- MotionGrid®
- MTi®
- MTx®
- MVN®
- mWSaver®
- OptoHiT™
- OPTOLOGIC®
- OPTOPLANAR®
- ®
- Power Supply WebDesigner™
- PowerTrench®
- PowerXS™
- Programmable Active Droop™
- QFET®
- QS™
- Quiet Series™
- RapidConfigure™
- ™
- Saving our world, 1mW/W/kW at a time™
- SignalWise™
- SmartMax™
- SMART START™
- Solutions for Your Success™
- SPM®
- STEALTH™
- SuperFET®
- SuperSOT™-3
- SuperSOT™-6
- SuperSOT™-8
- SupreMOS®
- SyncFET™
- Sync-Lock™
- ®
- TinyBoost®
- TinyBuck®
- TinyCalc™
- TinyLogic®
- TINYOPTO™
- TinyPower™
- TinyPWM™
- TinyWire™
- TranSiC™
- TriFault Detect™
- TRUECURRENT®*
- μSerDes™
- ™
- UHC®
- Ultra FRFET™
- UniFET™
- VcX™
- VisualMax™
- VoltagePlus™
- XS™
- Xsens™
- 仙童®

* Trademarks of System General Corporation, used under license by Fairchild Semiconductor.

DISCLAIMER

FAIRCHILD SEMICONDUCTOR RESERVES THE RIGHT TO MAKE CHANGES WITHOUT FURTHER NOTICE TO ANY PRODUCTS HEREIN TO IMPROVE RELIABILITY, FUNCTION, OR DESIGN. TO OBTAIN THE LATEST, MOST UP-TO-DATE DATASHEET AND PRODUCT INFORMATION, VISIT OUR WEBSITE AT [HTTP://WWW.FAIRCHILDSEMI.COM](http://www.fairchildsemi.com). FAIRCHILD DOES NOT ASSUME ANY LIABILITY ARISING OUT OF THE APPLICATION OR USE OF ANY PRODUCT OR CIRCUIT DESCRIBED HEREIN; NEITHER DOES IT CONVEY ANY LICENSE UNDER ITS PATENT RIGHTS, NOR THE RIGHTS OF OTHERS. THESE SPECIFICATIONS DO NOT EXPAND THE TERMS OF FAIRCHILD'S WORLDWIDE TERMS AND CONDITIONS, SPECIFICALLY THE WARRANTY THEREIN, WHICH COVERS THESE PRODUCTS.

AUTHORIZED USE

Unless otherwise specified in this data sheet, this product is a standard commercial product and is not intended for use in applications that require extraordinary levels of quality and reliability. This product may not be used in the following applications, unless specifically approved in writing by a Fairchild officer: (1) automotive or other transportation, (2) military/aerospace, (3) any safety critical application – including life critical medical equipment – where the failure of the Fairchild product reasonably would be expected to result in personal injury, death or property damage. Customer's use of this product is subject to agreement of this Authorized Use policy. In the event of an unauthorized use of Fairchild's product, Fairchild accepts no liability in the event of product failure. In other respects, this product shall be subject to Fairchild's Worldwide Terms and Conditions of Sale, unless a separate agreement has been signed by both Parties.

ANTI-COUNTERFEITING POLICY

Fairchild Semiconductor Corporation's Anti-Counterfeiting Policy. Fairchild's Anti-Counterfeiting Policy is also stated on our external website, www.fairchildsemi.com, under Terms of Use

Counterfeiting of semiconductor parts is a growing problem in the industry. All manufacturers of semiconductor products are experiencing counterfeiting of their parts. Customers who inadvertently purchase counterfeit parts experience many problems such as loss of brand reputation, substandard performance, failed applications, and increased cost of production and manufacturing delays. Fairchild is taking strong measures to protect ourselves and our customers from the proliferation of counterfeit parts. Fairchild strongly encourages customers to purchase Fairchild parts either directly from Fairchild or from Authorized Fairchild Distributors who are listed by country on our web page cited above. Products customers buy either from Fairchild directly or from Authorized Fairchild Distributors are genuine parts, have full traceability, meet Fairchild's quality standards for handling and storage and provide access to Fairchild's full range of up-to-date technical and product information. Fairchild and our Authorized Distributors will stand behind all warranties and will appropriately address any warranty issues that may arise. Fairchild will not provide any warranty coverage or other assistance for parts bought from Unauthorized Sources. Fairchild is committed to combat this global problem and encourage our customers to do their part in stopping this practice by buying direct or from authorized distributors.

PRODUCT STATUS DEFINITIONS

Definition of Terms

Datasheet Identification	Product Status	Definition
Advance Information	Formative / In Design	Datasheet contains the design specifications for product development. Specifications may change in any manner without notice.
Preliminary	First Production	Datasheet contains preliminary data; supplementary data will be published at a later date. Fairchild Semiconductor reserves the right to make changes at any time without notice to improve design.
No Identification Needed	Full Production	Datasheet contains final specifications. Fairchild Semiconductor reserves the right to make changes at any time without notice to improve the design.
Obsolete	Not In Production	Datasheet contains specifications on a product that is discontinued by Fairchild Semiconductor. The datasheet is for reference information only.

Rev. I77

Mouser Electronics

Authorized Distributor

Click to View Pricing, Inventory, Delivery & Lifecycle Information:

[Fairchild Semiconductor:](#)

[FQA90N15_F109](#)