



Is Now Part of



ON Semiconductor®

To learn more about ON Semiconductor, please visit our website at
www.onsemi.com

ON Semiconductor and the ON Semiconductor logo are trademarks of Semiconductor Components Industries, LLC dba ON Semiconductor or its subsidiaries in the United States and/or other countries. ON Semiconductor owns the rights to a number of patents, trademarks, copyrights, trade secrets, and other intellectual property. A listing of ON Semiconductor's product/patent coverage may be accessed at www.onsemi.com/site/pdf/Patent-Marking.pdf. ON Semiconductor reserves the right to make changes without further notice to any products herein. ON Semiconductor makes no warranty, representation or guarantee regarding the suitability of its products for any particular purpose, nor does ON Semiconductor assume any liability arising out of the application or use of any product or circuit, and specifically disclaims any and all liability, including without limitation special, consequential or incidental damages. Buyer is responsible for its products and applications using ON Semiconductor products, including compliance with all laws, regulations and safety requirements or standards, regardless of any support or applications information provided by ON Semiconductor. "Typical" parameters which may be provided in ON Semiconductor data sheets and/or specifications can and do vary in different applications and actual performance may vary over time. All operating parameters, including "Typicals" must be validated for each customer application by customer's technical experts. ON Semiconductor does not convey any license under its patent rights nor the rights of others. ON Semiconductor products are not designed, intended, or authorized for use as a critical component in life support systems or any FDA Class 3 medical devices or medical devices with a same or similar classification in a foreign jurisdiction or any devices intended for implantation in the human body. Should Buyer purchase or use ON Semiconductor products for any such unintended or unauthorized application, Buyer shall indemnify and hold ON Semiconductor and its officers, employees, subsidiaries, affiliates, and distributors harmless against all claims, costs, damages, and expenses, and reasonable attorney fees arising out of, directly or indirectly, any claim of personal injury or death associated with such unintended or unauthorized use, even if such claim alleges that ON Semiconductor was negligent regarding the design or manufacture of the part. ON Semiconductor is an Equal Opportunity/Affirmative Action Employer. This literature is subject to all applicable copyright laws and is not for resale in any manner.

KA431 / KA431A / KA431L

Programmable Shunt Regulator

Features

- Programmable Output Voltage to 36 V
- Low Dynamic Output Impedance: 0.2 Ω (Typical)
- Sink Current Capability: 1.0 to 100 mA
- Equivalent Full-Range Temperature Coefficient of 50 ppm/°C (Typical)
- Temperature Compensated for Operation Over Full Rated Operating Temperature Range
- Low Output Noise Voltage
- Fast Turn-on Response

Description

The KA431 / KA431A / KA431L are three-terminal adjustable regulators with a guaranteed thermal stability over the operating temperature range. The output voltage can be set to any value between V_{REF} (approximately 2.5 V) and 36 V with two external resistors. These devices have a typical dynamic output impedance of 0.2 Ω. Active output circuitry provides a sharp turn-on characteristic, making these devices excellent replacements for Zener diodes in many applications.

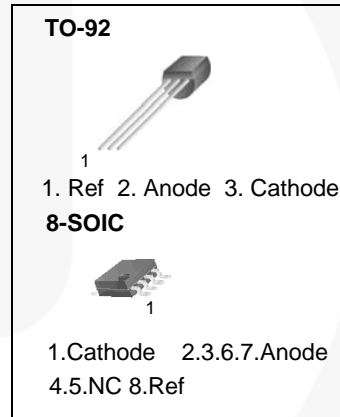

Ordering Information

Part Number	Operating Temperature Range	Output Voltage Tolerance	Top Mark	Package	Packing Method
KA431DTF	-25 ~ +85°C	2%	431	8-SOIC	Tape and Reel
KA431ADTF			431A	8-SOIC	Tape and Reel
KA431AZBU		1%	KA431AZ	TO-92	Bulk
KA431AZTA			KA431AZ	TO-92	Ammo
KA431LZTA			KA431LZ	TO-92	Ammo
		0.5%			

Block Diagram

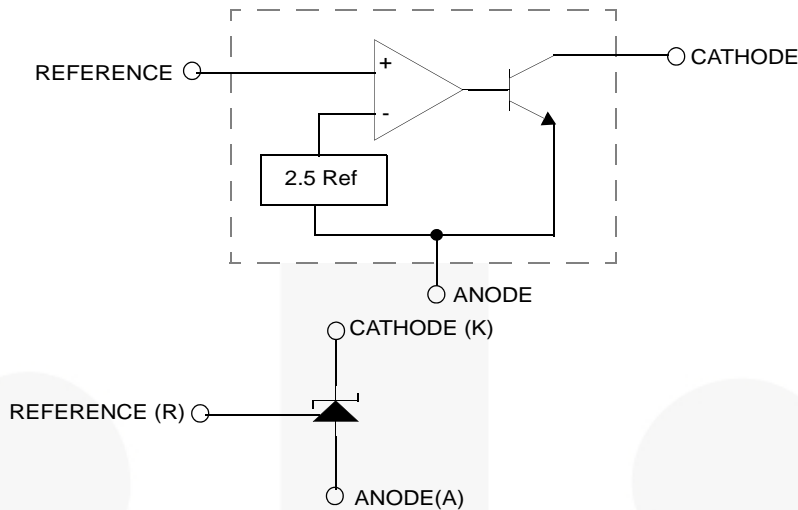

Figure 1. Block Diagram

Absolute Maximum Ratings

Stresses exceeding the absolute maximum ratings may damage the device. The device may not function or be operable above the recommended operating conditions and stressing the parts to these levels is not recommended. In addition, extended exposure to stresses above the recommended operating conditions may affect device reliability. The absolute maximum ratings are stress ratings only. Values are at $T_A = 25^\circ\text{C}$ unless otherwise noted.

Symbol	Parameter	Value	Unit
V_{KA}	Cathode Voltage	37	V
I_{KA}	Cathode Current Range (Continuous)	-100 to +150	mA
I_{REF}	Reference Input Current Range	-0.05 to +10	mA
P_D	Power Dissipation TO-92, 8-SOIC Packages	770	mW
$R_{\theta JA}$	Thermal Resistance, Junction to Ambient TO-92, 8-SOIC Packages	160	$^\circ\text{C}/\text{W}$
T_{OPR}	Operating Temperature Range	-25 to +85	$^\circ\text{C}$
T_J	Junction Temperature	150	$^\circ\text{C}$
T_{STG}	Storage Temperature Range	-65 to +150	$^\circ\text{C}$

Recommended Operating Conditions

The Recommended Operating Conditions table defines the conditions for actual device operation. Recommended operating conditions are specified to ensure optimal performance to the datasheet specifications. Fairchild does not recommend exceeding them or designing to Absolute Maximum Ratings.

Symbol	Parameter	Min.	Max.	Unit
V_{KA}	Cathode Voltage	V_{REF}	36	V
I_{KA}	Cathode Current	1	100	mA

Electrical Characteristics

Values are at $T_A = 25^\circ\text{C}$ unless otherwise noted.

Symbol	Parameter	Conditions	KA431			KA431A			KA431L			Unit
			Min.	Typ.	Max.	Min.	Typ.	Max.	Min.	Typ.	Max.	
V_{REF}	Reference Input Voltage	$V_{KA} = V_{REF}$, $I_{KA} = 10\text{ mA}$	2.450	2.500	2.550	2.470	2.495	2.520	2.482	2.495	2.508	V
$\Delta V_{REF}/\Delta T$	Deviation of Reference Input Voltage Over-Temperature	$V_{KA} = V_{REF}$, $I_{KA} = 10\text{ mA}$, $T_{MIN} \leq T_A \leq T_{MAX}^{(1)}$		4.5	17.0		4.5	17.0		4.5	17.0	mV
$\Delta V_{REF}/\Delta V_{KA}$	Ratio of Change in Reference Input Voltage to the Change in Cathode Voltage	$I_{KA} = 10\text{ mA}$	$\Delta V_{KA} = 10V - V_{REF}$	-1.0	-2.7		-1.0	-2.7		-1.0	-2.7	mV / V
			$\Delta V_{KA} = 36V - 10V$	-0.5	-2.0		-0.5	-2.0		-0.5	-2.0	
I_{REF}	Reference Input Current	$I_{KA} = 10\text{ mA}$, $R1 = 10\text{ k}\Omega$, $R2 = \infty$		1.5	4.0		1.5	4.0		1.5	4.0	μA
$\Delta I_{REF}/\Delta T$	Deviation of Reference Input Current Over Full Temperature Range	$I_{KA} = 10\text{ mA}$, $R1 = 10\text{ k}\Omega$, $R2 = \infty$, $T_A = \text{Full Range}$		0.4	1.2		0.4	1.2		0.4	1.2	μA
$I_{KA(MIN)}$	Minimum Cathode Current for Regulation	$V_{KA} = V_{REF}$		0.45	1.00		0.45	1.00		0.45	1.00	mA
$I_{KA(OFF)}$	Off - Stage Cathode Current	$V_{KA} = 36V$, $V_{REF} = 0$		0.05	1.00		0.05	1.00		0.05	1.00	μA
Z_{KA}	Dynamic Impedance	$V_{KA} = V_{REF}$, $I_{KA} = 1\text{ to }100\text{ mA}$, $f \geq 1.0\text{ kHz}$		0.15	0.50		0.15	0.50		0.15	0.50	Ω

Note:

- $T_{MIN} = -25^\circ\text{C}$, $T_{MAX} = +85^\circ\text{C}$.

Test Circuits

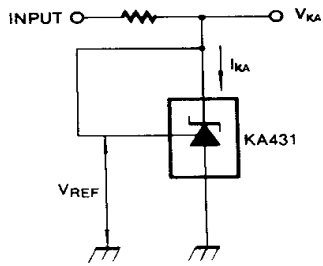

Figure 2. Test Circuit for $V_{KA} = V_{REF}$

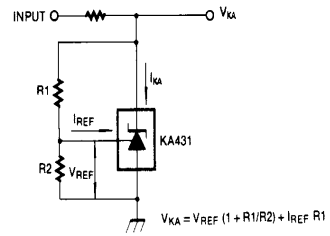

Figure 3. Test Circuit for $V_{KA} \geq V_{REF}$

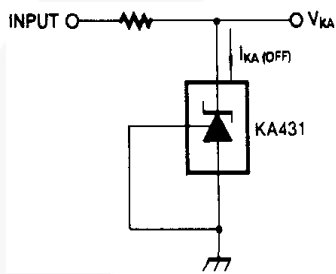

Figure 4. Test Circuit for $I_{KA(OFF)}$



Typical Performance Characteristics

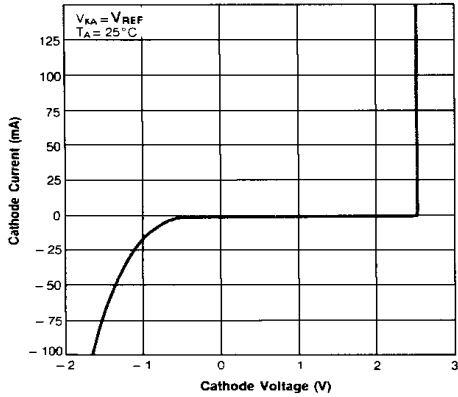

Figure 5. Cathode Current vs. Cathode Voltage

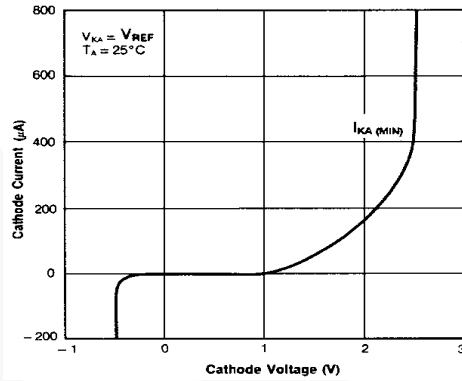

Figure 6. Cathode Current vs. Cathode Voltage

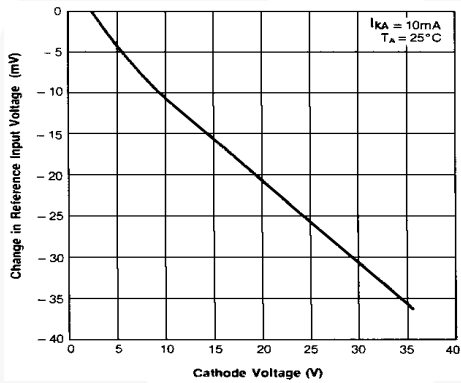

Figure 7. Change in Reference Input Voltage vs. Cathode Voltage

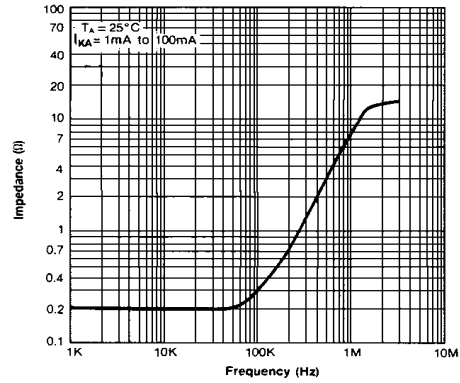

Figure 8. Dynamic Impedance Frequency

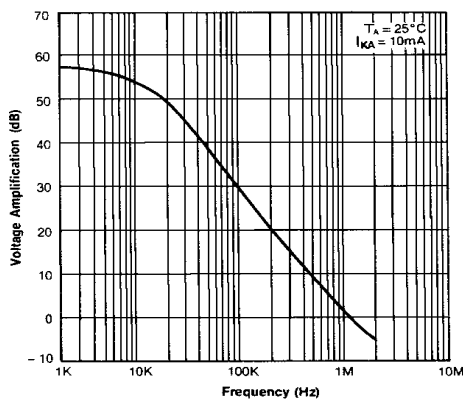

Figure 9. Small Signal Voltage Amplification vs. Frequency

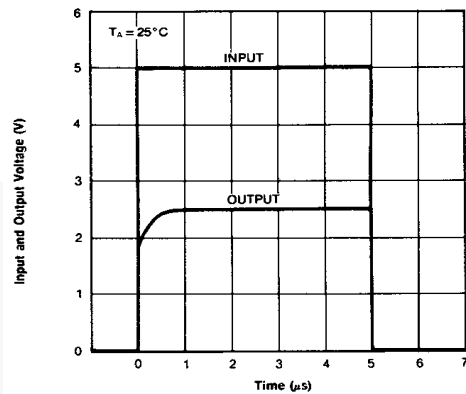

Figure 10. Pulse Response

Typical Performance Characteristics (Continued)

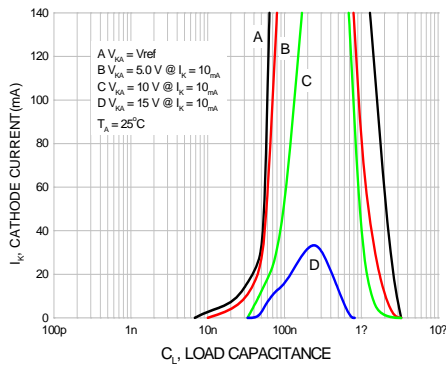

Figure11. Stability Boundary Conditions



Typical Application

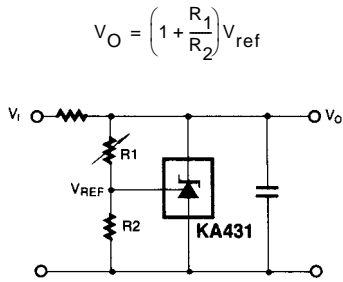

Figure 12. Shunt Regulator

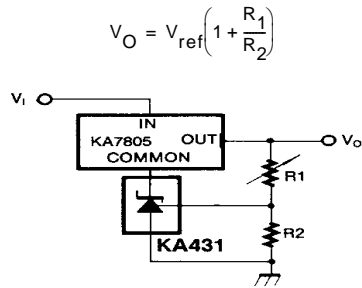

Figure 13. Output Control for Three-Terminal Fixed Regulator

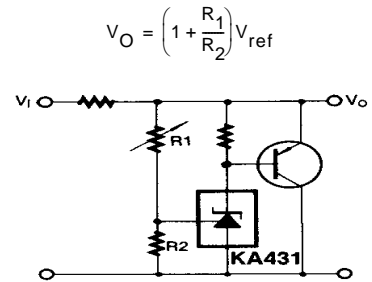

Figure 14. High-Current Shunt Regulator

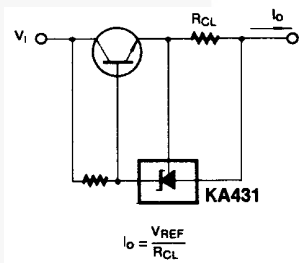

Figure 15. Current Limit or Current Source

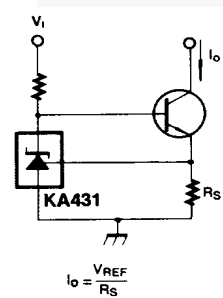
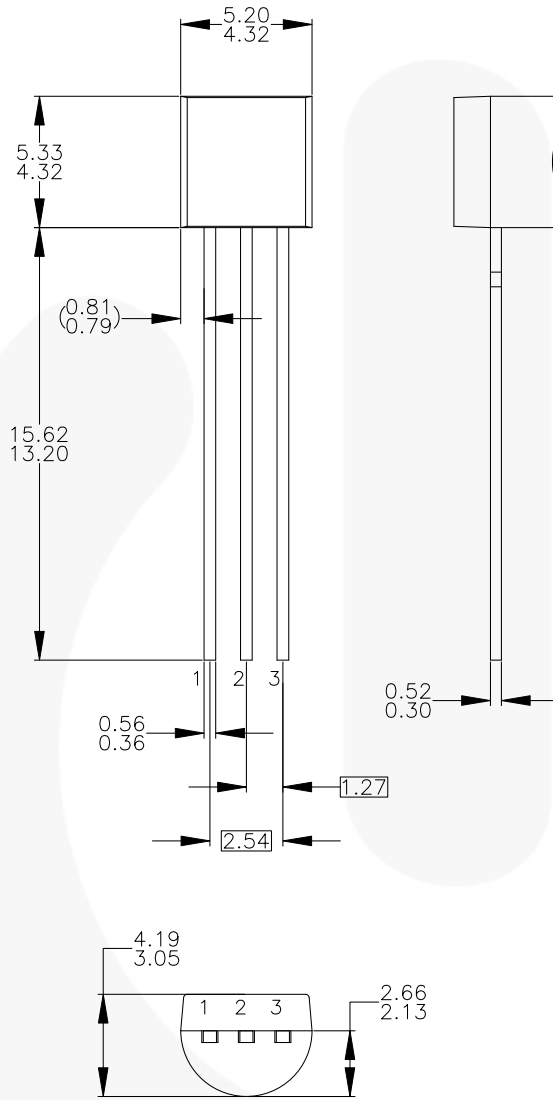

Figure 16. Constant-Current Sink

Physical Dimensions

TO-92 Bulk Type



- NOTES: UNLESS OTHERWISE SPECIFIED
- A) DRAWING WITH REFERENCE TO JEDEC TO-92 RECOMMENDATIONS.
 - B) ALL DIMENSIONS ARE IN MILLIMETERS.
 - C) DRAWING CONFORMS TO ASME Y14.5M-1994.
 - D) DRAWING FILENAME: MKT-ZA03DREV3.

Figure 17. 3-Lead, TO-92, Molded, Standard Straight Lead

Package drawings are provided as a service to customers considering Fairchild components. Drawings may change in any manner without notice. Please note the revision and/or date on the drawing and contact a Fairchild Semiconductor representative to verify or obtain the most recent revision. Package specifications do not expand the terms of Fairchild's worldwide terms and conditions, specifically the warranty therein, which covers Fairchild products.

Always visit Fairchild Semiconductor's online packaging area for the most recent package drawings:
<http://www.fairchildsemi.com/dwg/ZA/ZA03D.pdf>

For current tape and reel specifications, visit Fairchild Semiconductor's online packaging area:
http://www.fairchildsemi.com/packaging_dwg/PKG-ZA03D_BK.pdf

Physical Dimensions (Continued)

TO-92 Ammo Type

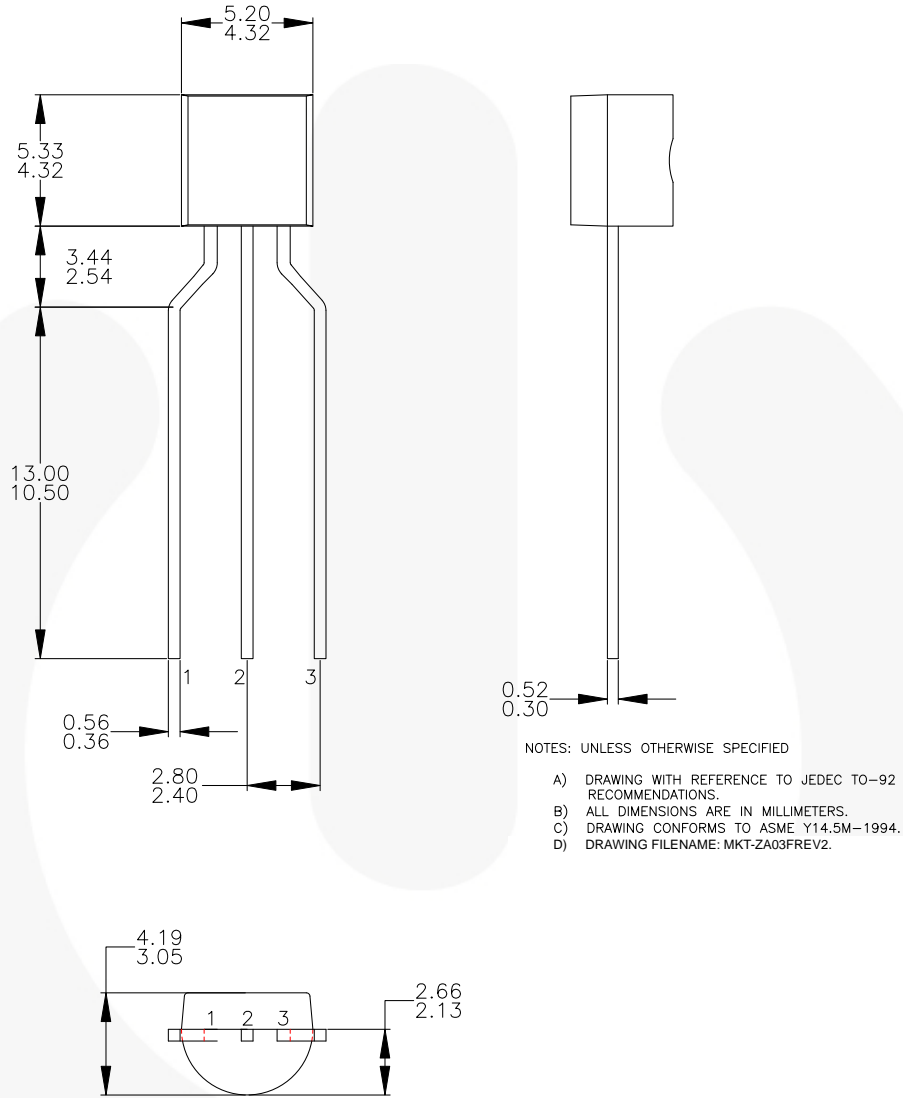

Figure 18. 3-Lead, TO-92, Molded, 0.200 in Line Spacing Lead Form

Package drawings are provided as a service to customers considering Fairchild components. Drawings may change in any manner without notice. Please note the revision and/or date on the drawing and contact a Fairchild Semiconductor representative to verify or obtain the most recent revision. Package specifications do not expand the terms of Fairchild's worldwide terms and conditions, specifically the warranty therein, which covers Fairchild products.

Always visit Fairchild Semiconductor's online packaging area for the most recent package drawings:

<http://www.fairchildsemi.com/dwg/ZA03F.pdf>

For current tape and reel specifications, visit Fairchild Semiconductor's online packaging area:

http://www.fairchildsemi.com/packing_dwg/PKG-ZA03F_BK.pdf

Physical Dimensions (Continued)

8-SOIC

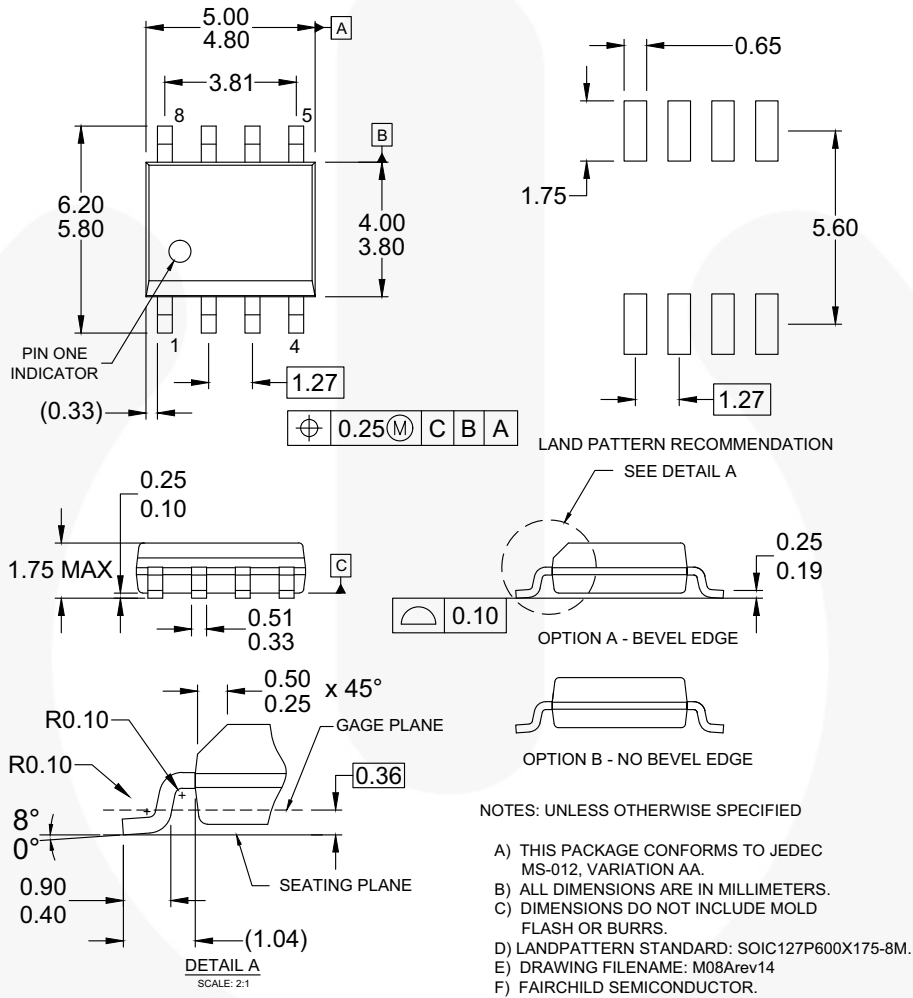

Figure 19. 8-Lead, SOIC, JEDEC MS 0-12, 0.150 inch Narrow Body

Package drawings are provided as a service to customers considering Fairchild components. Drawings may change in any manner without notice. Please note the revision and/or date on the drawing and contact a Fairchild Semiconductor representative to verify or obtain the most recent revision. Package specifications do not expand the terms of Fairchild's worldwide terms and conditions, specifically the warranty therein, which covers Fairchild products.





Always visit Fairchild Semiconductor's online packaging area for the most recent package drawings:
<http://www.fairchildsemi.com/dwg/M0/M08A.pdf>

For current tape and reel specifications, visit Fairchild Semiconductor's online packaging area:
http://www.fairchildsemi.com/packaging_dwq/PKG-M08A_PSTS.pdf



TRADEMARKS

The following includes registered and unregistered trademarks and service marks, owned by Fairchild Semiconductor and/or its global subsidiaries, and is not intended to be an exhaustive list of all such trademarks.

2Cool™	FPS™		Sync-Lock™
AccuPower™	F-PFS™	PowerTrench®	
AX-CAP®*	FRFET®	PowerXS™	TinyBoost™
BitSiC™	Global Power Resource SM	Programmable Active Droop™	TinyBuck™
Build it Now™	GreenBridge™	QFET®	TinyCalc™
CorePLUS™	Green FPS™	QS™	TinyLogic®
CorePOWER™	Green FPS™ e-Series™	Quiet Series™	TINYOPTO™
CROSSVOLT™	Gmax™	RapidConfigure™	TinyPower™
CTL™	GTO™		TinyPWM™
Current Transfer Logic™	IntelliMAX™	Saving our world, 1mW/W/kW at a time™	TinyWire™
DEUXPEED®	ISOPLANAR™	SignalWise™	TranSiC™
Dual Cool™	Making Small Speakers Sound Louder and Better™	SmartMax™	TriFault Detect™
EcoSPARK®	MegaBuck™	SMART START™	TRUECURRENT®*
EfficientMax™	MICROCOUPLER™	Solutions for Your Success™	μSerDes™
ESBC™	MicroFET™	SPM®	
	MicroPak™	STEALTH™	UHC®
Fairchild®	MicroPak2™	SuperFET®	Ultra FRFET™
Fairchild Semiconductor®	MillerDrive™	SuperSOT™-3	UniFET™
FACT Quiet Series™	MotionMax™	SuperSOT™-6	VCX™
FACT®	mWSaver™	SuperSOT™-8	VisualMax™
FAST®	OptoHi™	SupreMOS®	VoltagePlus™
FastvCore™	OPTOLOGIC®	SyncFET™	XS™
FETBench™	OPTOPLANAR®		

* Trademarks of System General Corporation, used under license by Fairchild Semiconductor.

DISCLAIMER

FAIRCHILD SEMICONDUCTOR RESERVES THE RIGHT TO MAKE CHANGES WITHOUT FURTHER NOTICE TO ANY PRODUCTS HEREIN TO IMPROVE RELIABILITY, FUNCTION, OR DESIGN. FAIRCHILD DOES NOT ASSUME ANY LIABILITY ARISING OUT OF THE APPLICATION OR USE OF ANY PRODUCT OR CIRCUIT DESCRIBED HEREIN; NEITHER DOES IT CONVEY ANY LICENSE UNDER ITS PATENT RIGHTS, NOR THE RIGHTS OF OTHERS. THESE SPECIFICATIONS DO NOT EXPAND THE TERMS OF FAIRCHILD'S WORLDWIDE TERMS AND CONDITIONS, SPECIFICALLY THE WARRANTY THEREIN, WHICH COVERS THESE PRODUCTS.

LIFE SUPPORT POLICY

FAIRCHILD'S PRODUCTS ARE NOT AUTHORIZED FOR USE AS CRITICAL COMPONENTS IN LIFE SUPPORT DEVICES OR SYSTEMS WITHOUT THE EXPRESS WRITTEN APPROVAL OF FAIRCHILD SEMICONDUCTOR CORPORATION.

As used herein:

1. Life support devices or systems are devices or systems which, (a) are intended for surgical implant into the body or (b) support or sustain life, and (c) whose failure to perform when properly used in accordance with instructions for use provided in the labeling, can be reasonably expected to result in a significant injury of the user.
2. A critical component in any component of a life support, device, or system whose failure to perform can be reasonably expected to cause the failure of the life support device or system, or to affect its safety or effectiveness.

ANTI-COUNTERFEITING POLICY

Fairchild Semiconductor Corporation's Anti-Counterfeiting Policy. Fairchild's Anti-Counterfeiting Policy is also stated on our external website, www.fairchildsemi.com, under Sales Support.

Counterfeiting of semiconductor parts is a growing problem in the industry. All manufacturers of semiconductor products are experiencing counterfeiting of their parts. Customers who inadvertently purchase counterfeit parts experience many problems such as loss of brand reputation, substandard performance, failed applications, and increased cost of production and manufacturing delays. Fairchild is taking strong measures to protect ourselves and our customers from the proliferation of counterfeit parts. Fairchild strongly encourages customers to purchase Fairchild parts either directly from Fairchild or from Authorized Fairchild Distributors who are listed by country on our web page cited above. Products customers buy either from Fairchild directly or from Authorized Fairchild Distributors are genuine parts, have full traceability, meet Fairchild's quality standards for handling and storage and provide access to Fairchild's full range of up-to-date technical and product information. Fairchild and our Authorized Distributors will stand behind all warranties and will appropriately address any warranty issues that may arise. Fairchild will not provide any warranty coverage or other assistance for parts bought from Unauthorized Sources. Fairchild is committed to combat this global problem and encourage our customers to do their part in stopping this practice by buying direct or from authorized distributors.

PRODUCT STATUS DEFINITIONS

Definition of Terms

Datasheet Identification	Product Status	Definition
Advance Information	Formative / In Design	Datasheet contains the design specifications for product development. Specifications may change in any manner without notice.
Preliminary	First Production	Datasheet contains preliminary data; supplementary data will be published at a later date. Fairchild Semiconductor reserves the right to make changes at any time without notice to improve design.
No Identification Needed	Full Production	Datasheet contains final specifications. Fairchild Semiconductor reserves the right to make changes at any time without notice to improve the design.
Obsolete	Not In Production	Datasheet contains specifications on a product that is discontinued by Fairchild Semiconductor. The datasheet is for reference information only.

Mouser Electronics

Authorized Distributor

Click to View Pricing, Inventory, Delivery & Lifecycle Information:

[Fairchild Semiconductor:](#)

[KA431DTF](#)