

Si4410DYPbF

HEXFET® Power MOSFET

- N-Channel MOSFET
- Low On-Resistance
- Low Gate Charge
- Surface Mount
- Logic Level Drive
- Lead-Free

Description

This N-channel HEXFET® Power MOSFET is produced using International Rectifier's advanced HEXFET power MOSFET technology. The low on-resistance and low gate charge inherent to this technology make this device ideal for low voltage or battery driven power conversion applications

The SO-8 package with copper leadframe offers enhanced thermal characteristics that allow power dissipation of greater than 800mW in typical board mount applications.

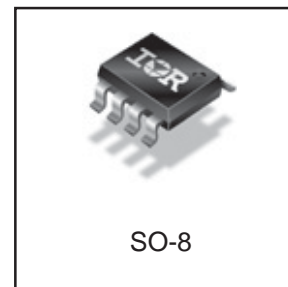
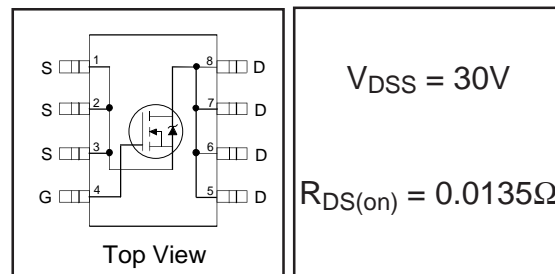

Absolute Maximum Ratings

	Parameter	Max.	Units
V_{DS}	Drain- Source Voltage	30	V
$I_D @ T_A = 25^\circ C$	Continuous Drain Current, $V_{GS} @ 10V$	± 10	A
$I_D @ T_A = 70^\circ C$	Continuous Drain Current, $V_{GS} @ 10V$	± 8.0	
I_{DM}	Pulsed Drain Current ①	± 50	
$P_D @ T_A = 25^\circ C$	Power Dissipation ③	2.5	W
$P_D @ T_A = 70^\circ C$	Power Dissipation ③	1.6	
	Linear Derating Factor	0.02	W/°C
dv/dt	Peak Diode Recovery dv/dt ②	5.0	V/ns
E_{AS}	Single Pulse Avalanche Energy④	400	mJ
V_{GS}	Gate-to-Source Voltage	± 20	V
T_J, T_{STG}	Junction and Storage Temperature Range	-55 to + 150	°C

Thermal Resistance

	Parameter	Max.	Units
$R_{\theta JA}$	Maximum Junction-to-Ambient③	50	°C/W

Electrical Characteristics @ T_J = 25°C (unless otherwise specified)

	Parameter	Min.	Typ.	Max.	Units	Conditions
V _{(BR)DSS}	Drain-to-Source Breakdown Voltage	30	—	—	V	V _{GS} = 0V, I _D = 250μA
ΔV _{(BR)DSS} /ΔT _J	Breakdown Voltage Temp. Coefficient	—	0.029	—	V/°C	Reference to 25°C, I _D = 1mA
R _{DS(on)}	Static Drain-to-Source On-Resistance	—	0.010	0.0135	Ω	V _{GS} = 10V, I _D = 10A ②
		—	0.015	0.020		V _{GS} = 4.5V, I _D = 5.0A ②
V _{GS(th)}	Gate Threshold Voltage	1.0	—	—	V	V _{DS} = V _{GS} , I _D = 250μA
g _{fs}	Forward Transconductance	—	35	—	S	V _{DS} = 15V, I _D = 10A
I _{DSS}	Drain-to-Source Leakage Current	—	—	1.0	μA	V _{DS} = 30V, V _{GS} = 0V
		—	—	25		V _{DS} = 30V, V _{GS} = 0V, T _J = 55°C
I _{GSS}	Gate-to-Source Forward Leakage	—	—	-100	nA	V _{GS} = -20V
	Gate-to-Source Reverse Leakage	—	—	100		V _{GS} = 20V
Q _g	Total Gate Charge	—	30	45	nC	I _D = 10A
Q _{gs}	Gate-to-Source Charge	—	5.4	—		V _{DS} = 15V
Q _{gd}	Gate-to-Drain ("Miller") Charge	—	6.5	—		V _{GS} = 10V, See Fig. 10 ②
t _{d(on)}	Turn-On Delay Time	—	11	—	ns	V _{DD} = 25V
t _r	Rise Time	—	7.7	—		I _D = 1.0A
t _{d(off)}	Turn-Off Delay Time	—	38	—		R _G = 6.0Ω
t _f	Fall Time	—	44	—		R _D = 25Ω, ②
C _{iss}	Input Capacitance	—	1585	—	pF	V _{GS} = 0V
C _{oss}	Output Capacitance	—	739	—		V _{DS} = 15V
C _{rss}	Reverse Transfer Capacitance	—	106	—		f = 1.0MHz, See Fig. 9

Source-Drain Ratings and Characteristics

	Parameter	Min.	Typ.	Max.	Units	Conditions
I _S	Continuous Source Current (Diode Conduction)③	—	—	2.3	A	MOSFET symbol showing the integral reverse p-n junction diode.
I _{SM}	Pulsed Source Current (Body Diode) ①	—	—	50		
V _{SD}	Diode Forward Voltage	—	0.7	1.1	V	T _J = 25°C, I _S = 2.3A, V _{GS} = 0V ②
t _{rr}	Reverse Recovery Time	—	50	80	ns	T _J = 25°C, I _F = 2.3A

Notes:

- ① Repetitive rating; pulse width limited by max. junction temperature.
- ② Pulse width ≤ 300μs; duty cycle ≤ 2%.
- ③ When mounted on FR4 Board, t ≤ 10 sec
- ④ Starting T_J = 25°C, L = 8.0mH
R_G = 25Ω, I_{AS} = 10A. (See Figure 15)
- ⑤ I_{SD} ≤ 2.3A, di/dt ≤ 130A/μs, V_{DD} ≤ V_{(BR)DSS},
T_J ≤ 150°C

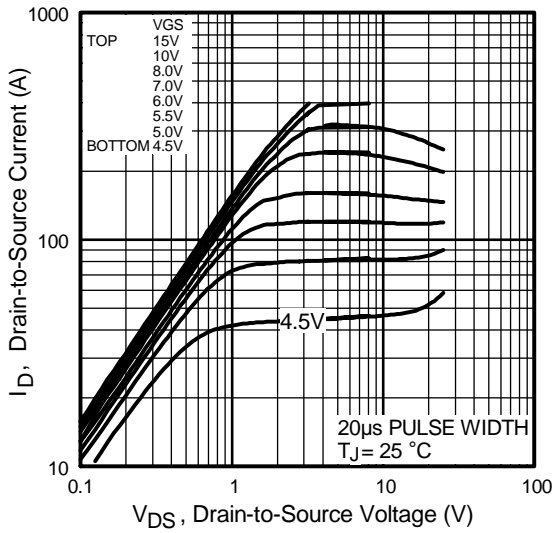

Fig 1. Typical Output Characteristics

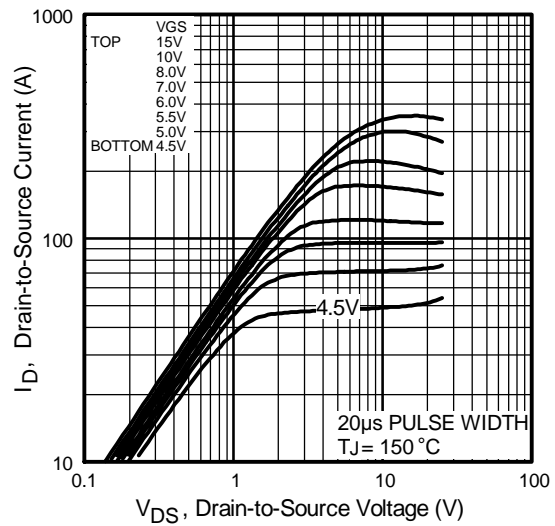

Fig 2. Typical Output Characteristics

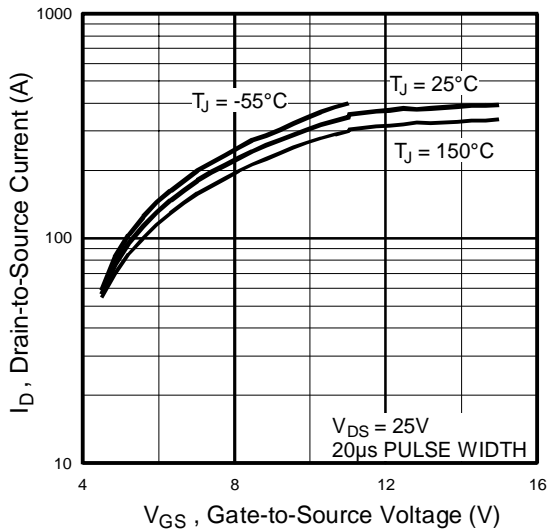

Fig 3. Typical Transfer Characteristics

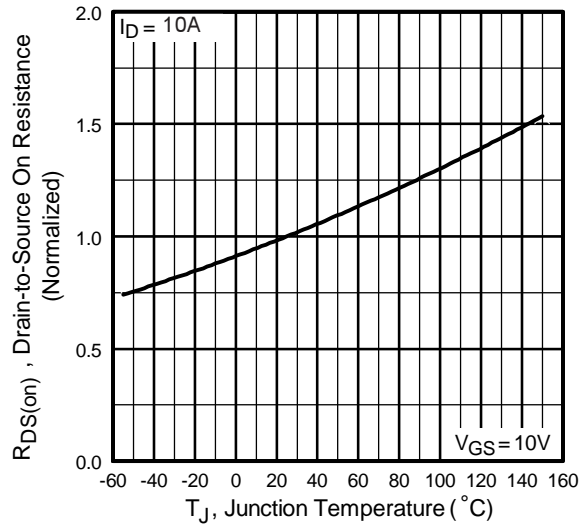

Fig 4. Normalized On-Resistance Vs. Temperature

Si4410DYPbF

International
IRF Rectifier

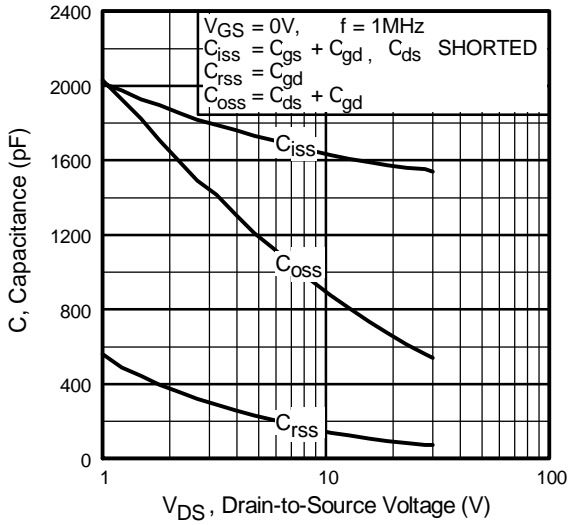

Fig 5. Typical Capacitance Vs. Drain-to-Source Voltage

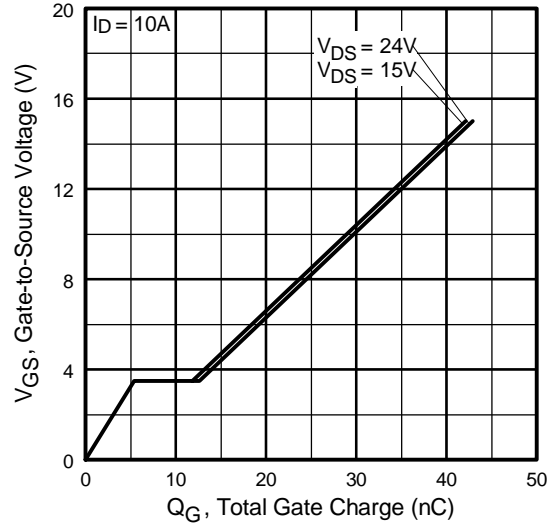

Fig 6. Typical Gate Charge Vs. Gate-to-Source Voltage

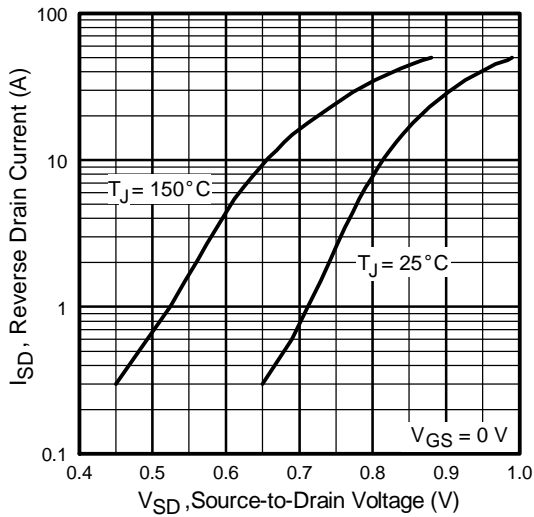

Fig 7. Typical Source-Drain Diode Forward Voltage

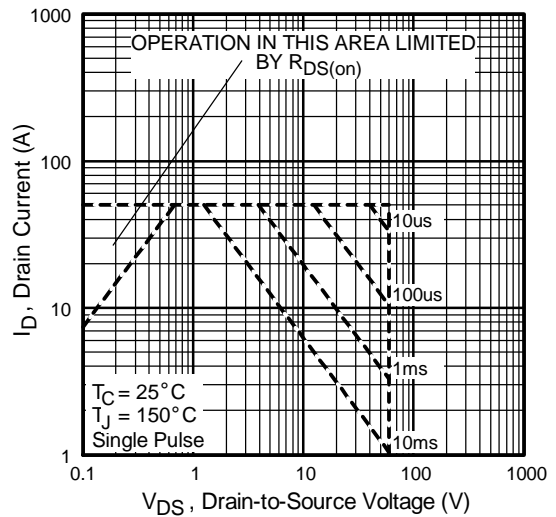

Fig 8. Maximum Safe Operating Area

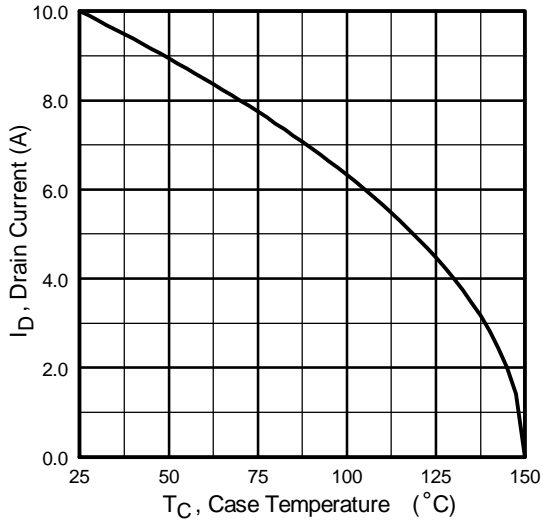

Fig 9. Maximum Drain Current Vs. Case Temperature

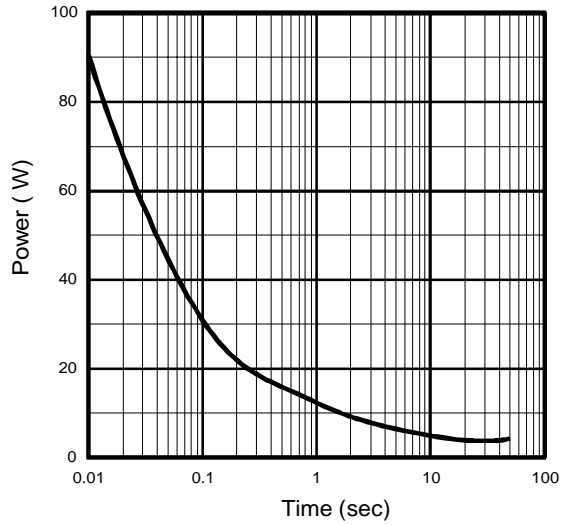

Fig 10. Typical Power Vs. Time

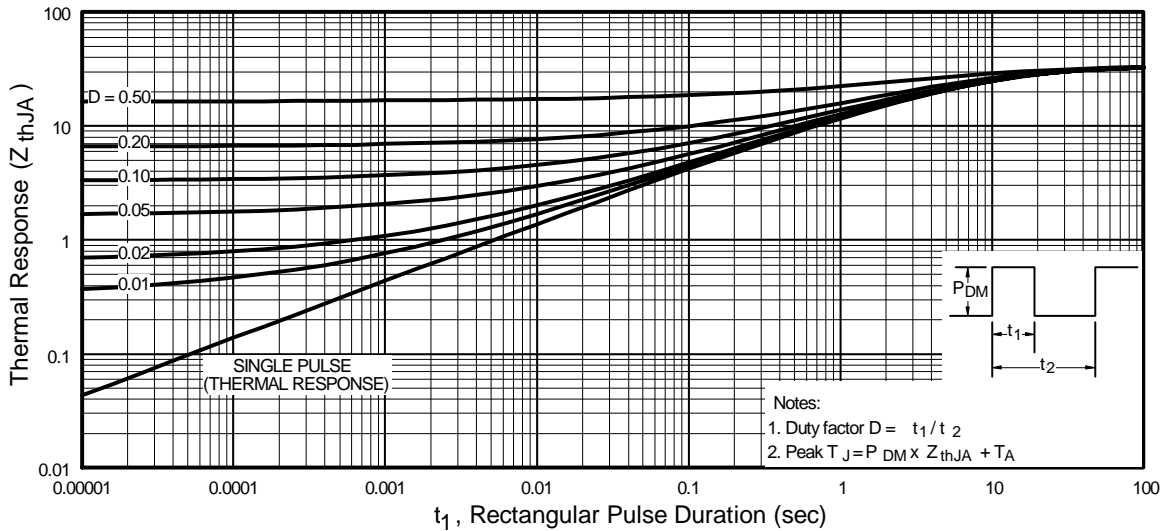

Fig 11. Typical Effective Transient Thermal Impedance, Junction-to-Ambient

Si4410DYPbF

International
IR Rectifier

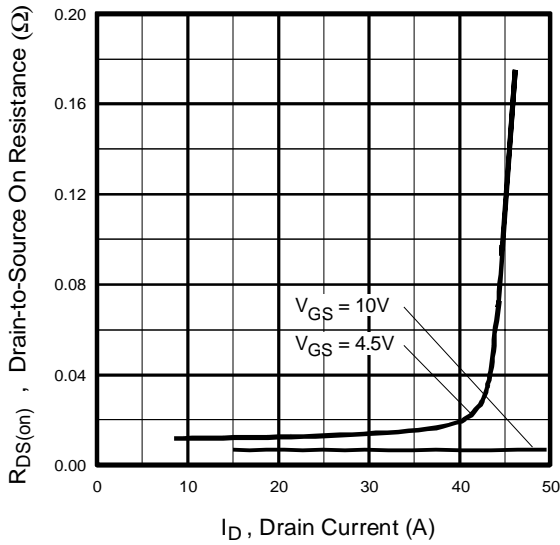

Fig 12. Typical On-Resistance Vs. Drain Current

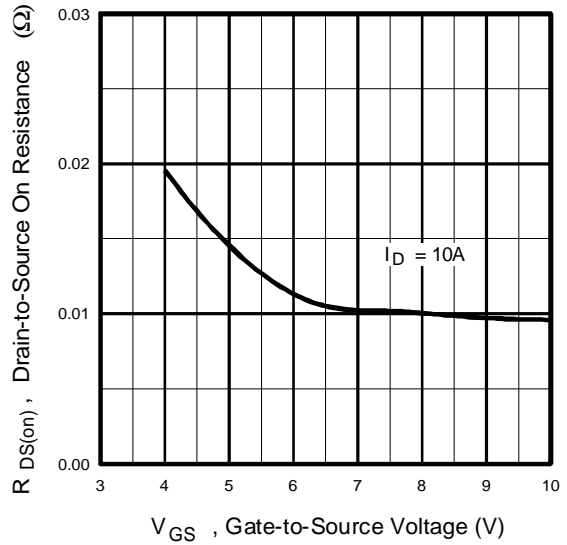

Fig 13. Typical On-Resistance Vs. Gate Voltage

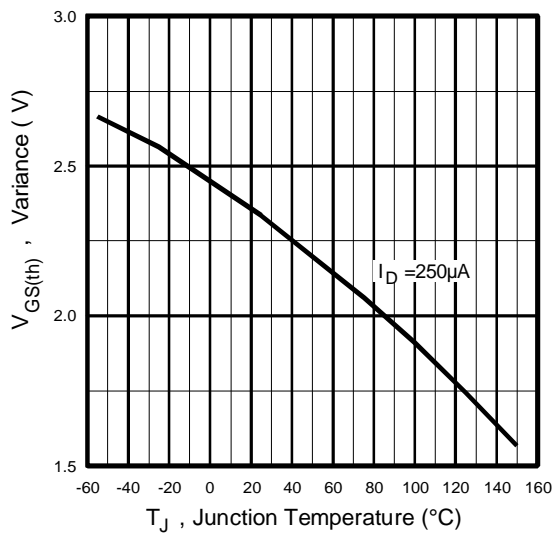

Fig 14. Typical Threshold Voltage Vs. Temperature

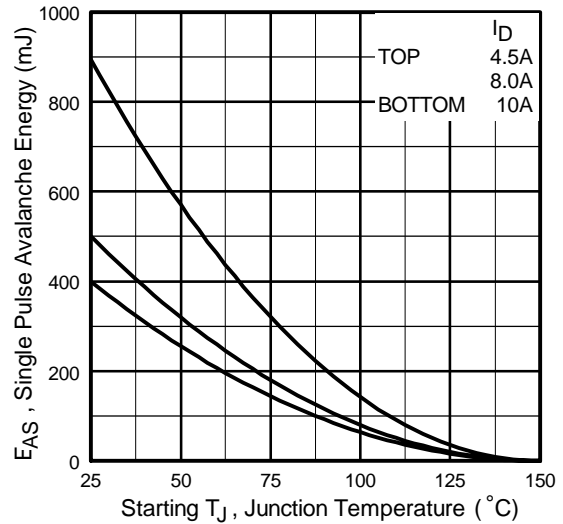
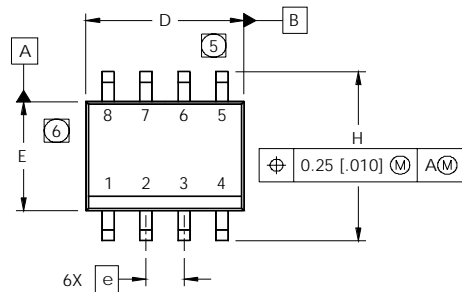

Fig 15. Maximum Avalanche Energy Vs. Drain Current

SO-8 Package Outline

Dimensions are shown in millimeters (inches)



DIM	INCHES		MILLIMETERS	
	MIN	MAX	MIN	MAX
A	.0532	.0688	1.35	1.75
A1	.0040	.0098	0.10	0.25
b	.013	.020	0.33	0.51
c	.0075	.0098	0.19	0.25
D	.189	.1968	4.80	5.00
E	.1497	.1574	3.80	4.00
e	.050 BASIC		1.27 BASIC	
e1	.025 BASIC		0.635 BASIC	
H	.2284	.2440	5.80	6.20
K	.0099	.0196	0.25	0.50
L	.016	.050	0.40	1.27
y	0°	8°	0°	8°

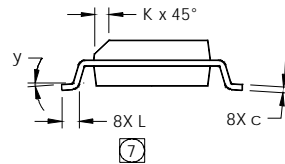
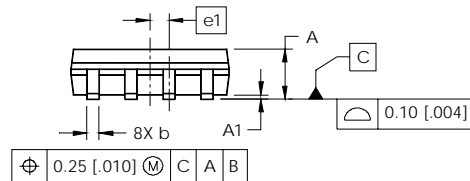

NOTES:

1. DIMENSIONING & TOLERANCING PER ASME Y14.5M-1994.
2. CONTROLLING DIMENSION: MILLIMETER
3. DIMENSIONS ARE SHOWN IN MILLIMETERS [INCHES].
4. OUTLINE CONFORMS TO JEDEC OUTLINE MS-012AA.
- ⑤ DIMENSION DOES NOT INCLUDE MOLD PROTRUSIONS. MOLD PROTRUSIONS NOT TO EXCEED 0.15 [0.006].
- ⑥ DIMENSION DOES NOT INCLUDE MOLD PROTRUSIONS. MOLD PROTRUSIONS NOT TO EXCEED 0.25 [0.010].
- ⑦ DIMENSION IS THE LENGTH OF LEAD FOR SOLDERING TO A SUBSTRATE.

FOOTPRINT

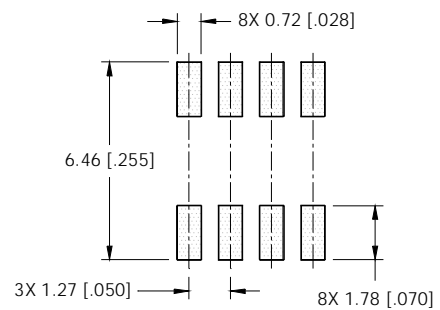

SO-8 Part Marking

EXAMPLE: THIS IS AN IRF7101 (MOSFET)

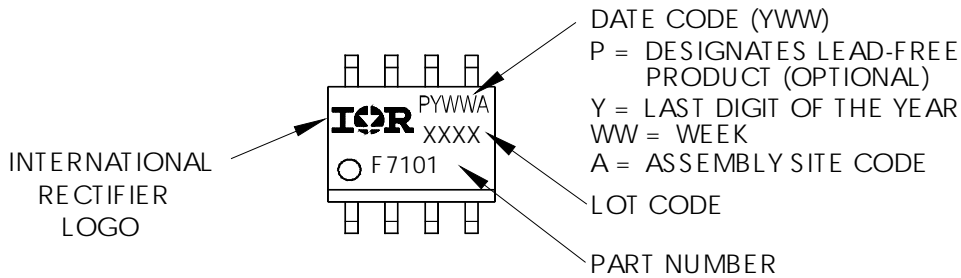

Si4410DYPbF

International
IR Rectifier

SO-8 Tape and Reel

Dimensions are shown in millimeters (inches)

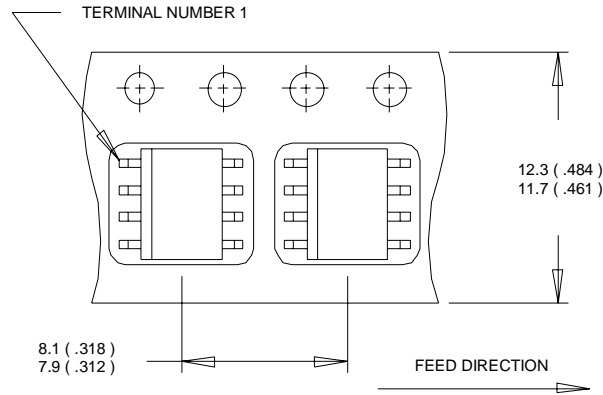

NOTES:

1. CONTROLLING DIMENSION : MILLIMETER.
2. ALL DIMENSIONS ARE SHOWN IN MILLIMETERS(INCHES).
3. OUTLINE CONFORMS TO EIA-481 & EIA-541.

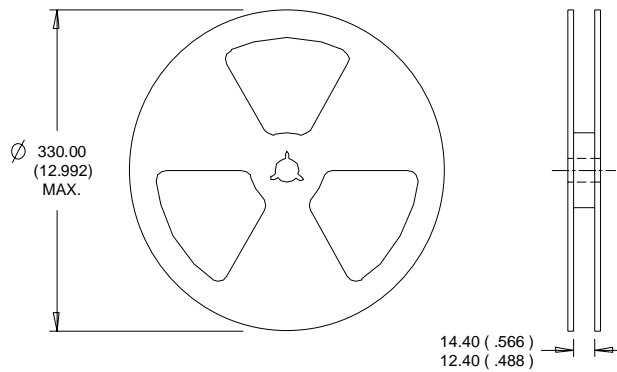

NOTES:

1. CONTROLLING DIMENSION : MILLIMETER.
2. OUTLINE CONFORMS TO EIA-481 & EIA-541.

Data and specifications subject to change without notice.
This product has been designed and qualified for the Consumer market.
Qualifications Standards can be found on IR's Web site.

International
IR Rectifier

IR WORLD HEADQUARTERS: 233 Kansas St., El Segundo, California 90245, USA Tel: (310) 252-7105
TAC Fax: (310) 252-7903

Visit us at www.irf.com for sales contact information.09/04

www.irf.com

Mouser Electronics

Authorized Distributor

Click to View Pricing, Inventory, Delivery & Lifecycle Information:

[International Rectifier:](#)

[SI4410DYPBF](#) [SI4410DYTRPBF](#)