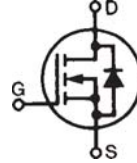

**Depletion Mode
MOSFETs**
**IXTH10N100D2
IXTT10N100D2**

$$V_{DSX} = 1000V$$

$$I_{D(on)} \geq 10A$$

$$R_{DS(on)} \leq 1.5\Omega$$

N-Channel

Symbol	Test Conditions	Maximum Ratings	
V_{DSX}	$T_J = 25^\circ\text{C to } 150^\circ\text{C}$	1000	V
V_{DGX}	$T_J = 25^\circ\text{C to } 150^\circ\text{C}, R_{GS} = 1M\Omega$	1000	V
V_{GSX}	Continuous	± 20	V
V_{GSM}	Transient	± 30	V
P_D	$T_C = 25^\circ\text{C}$	695	W
T_J		- 55 ... +150	$^\circ\text{C}$
T_{JM}		150	$^\circ\text{C}$
T_{stg}		- 55 ... +150	$^\circ\text{C}$
T_L	1.6mm (0.062 in.) from Case for 10s	300	$^\circ\text{C}$
T_{SOLD}	Plastic Body for 10s	260	$^\circ\text{C}$
M_d	Mounting Torque (TO-247)	1.13 / 10	Nm/lb.in.
Weight	TO-247	6	g
	TO-268	4	g

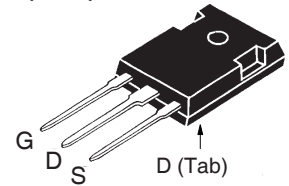
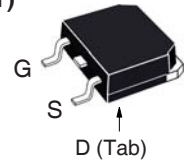
TO-247 (IXTH)

TO-268 (IXTT)

G = Gate D = Drain
S = Source Tab = Drain

Symbol	Test Conditions ($T_J = 25^\circ\text{C}$, Unless Otherwise Specified)	Characteristic Values		
		Min.	Typ.	Max.
BV_{DSX}	$V_{GS} = -5V, I_D = 250\mu\text{A}$	1000		V
$V_{GS(off)}$	$V_{DS} = 25V, I_D = 1\text{mA}$	- 2.5		- 4.5 V
I_{GSX}	$V_{GS} = \pm 20V, V_{DS} = 0V$			± 100 nA
$I_{DSX(off)}$	$V_{DS} = V_{DSX}, V_{GS} = -5V$ $T_J = 125^\circ\text{C}$			10 μA 250 μA
$R_{DS(on)}$	$V_{GS} = 0V, I_D = 5A, \text{ Note 1}$			1.5 Ω
$I_{D(on)}$	$V_{GS} = 0V, V_{DS} = 25V, \text{ Note 1}$	10		A

Features

- Normally ON Mode
- International Standard Packages
- Molding Epoxies Meet UL94V-0 Flammability Classification

Advantages

- Easy to Mount
- Space Savings
- High Power Density

Applications

- Audio Amplifiers
- Start-up Circuits
- Protection Circuits
- Ramp Generators
- Current Regulators
- Active Loads

Symbol	Test Conditions ($T_J = 25^\circ\text{C}$, Unless Otherwise Specified)	Characteristic Values		
		Min.	Typ.	Max.
g_{fs}	$V_{DS} = 30\text{V}$, $I_D = 5\text{A}$, Note 1	11	17	S
C_{iss}	$V_{GS} = -10\text{V}$, $V_{DS} = 25\text{V}$, $f = 1\text{MHz}$		5320	pF
C_{oss}			300	pF
C_{rss}			70	pF
$t_{d(on)}$	Resistive Switching Times $V_{GS} = \pm 5\text{V}$, $V_{DS} = 500\text{V}$, $I_D = 5\text{A}$ $R_G = 3.3\Omega$ (External)		33	ns
t_r			36	ns
$t_{d(off)}$			33	ns
t_f			164	ns
$Q_{g(on)}$	$V_{GS} = \pm 5\text{V}$, $V_{DS} = 500\text{V}$, $I_D = 5\text{A}$		200	nC
Q_{gs}			19	nC
Q_{gd}			98	nC
R_{thJC}	TO-247			0.18 $^\circ\text{C/W}$
R_{thCS}			0.21	$^\circ\text{C/W}$

Safe-Operating-Area Specification

Symbol	Test Conditions	Characteristic Values		
		Min.	Typ.	Max.
SOA	$V_{DS} = 800\text{V}$, $I_D = 0.22\text{A}$, $T_C = 75^\circ\text{C}$, $t_p = 5\text{s}$	176		W

Source-Drain Diode

Symbol	Test Conditions ($T_J = 25^\circ\text{C}$, Unless Otherwise Specified)	Characteristic Values		
		Min.	Typ.	Max.
V_{SD}	$I_F = 10\text{A}$, $V_{GS} = -10\text{V}$, Note 1		0.8	1.3 V
t_{rr}	$I_F = 5\text{A}$, $-di/dt = 100\text{A}/\mu\text{s}$ $V_R = 100\text{V}$, $V_{GS} = -10\text{V}$		1.2	μs
I_{RM}			23	A
Q_{RM}			13.8	μC

Note 1. Pulse test, $t \leq 300\mu\text{s}$, duty cycle, $d \leq 2\%$.

ADVANCE TECHNICAL INFORMATION

The product presented herein is under development. The Technical Specifications offered are derived from a subjective evaluation of the design, based upon prior knowledge and experience, and constitute a "considered reflection" of the anticipated result. IXYS reserves the right to change limits, test conditions, and dimensions without notice.

IXYS Reserves the Right to Change Limits, Test Conditions, and Dimensions.

IXYS MOSFETs and IGBTs are covered 4,835,592 4,931,844 5,049,961 5,237,481 6,162,665 6,404,065 B1 6,683,344 6,727,585 7,005,734 B2 7,157,338B2
by one or more of the following U.S. patents: 4,850,072 5,017,508 5,063,307 5,381,025 6,259,123 B1 6,534,343 6,710,405 B2 6,759,692 7,063,975 B2
4,881,106 5,034,796 5,187,117 5,486,715 6,306,728 B1 6,583,505 6,710,463 6,771,478 B2 7,071,537

TO-247 Outline

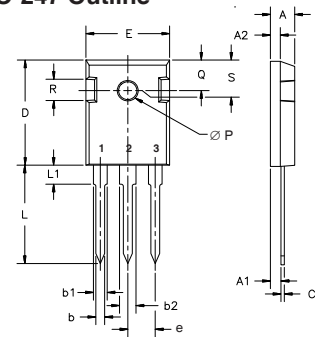

Terminals: 1 - Gate 2 - Drain
3 - Source

Dim.	Millimeter		Inches	
	Min.	Max.	Min.	Max.
A	4.7	5.3	.185	.209
A ₁	2.2	2.54	.087	.102
A ₂	2.2	2.6	.059	.098
b	1.0	1.4	.040	.055
b ₁	1.65	2.13	.065	.084
b ₂	2.87	3.12	.113	.123
C	.4	.8	.016	.031
D	20.80	21.46	.819	.845
E	15.75	16.26	.610	.640
e	5.20	5.72	0.205	0.225
L	19.81	20.32	.780	.800
L ₁		4.50		.177
∅P	3.55	3.65	.140	.144
Q	5.89	6.40	0.232	0.252
R	4.32	5.49	.170	.216
S	6.15	BSC	242	BSC

TO-268 Outline

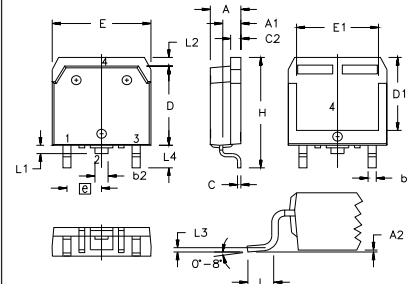

Terminals: 1 - Gate 2,4 - Drain
3 - Source

SYM	INCHES		MILLIMETERS	
	MIN	MAX	MIN	MAX
A	.193	.201	4.90	5.10
A ₁	.106	.114	2.70	2.90
A ₂	.001	.010	0.02	0.25
b	.045	.057	1.15	1.45
b ₂	.075	.083	1.90	2.10
C	.016	.026	0.40	0.65
C ₂	.057	.063	1.45	1.60
D	.543	.551	13.80	14.00
D ₁	.488	.500	12.40	12.70
E	.624	.632	15.85	16.05
E ₁	.524	.535	13.30	13.60
e	.215 BSC		5.45 BSC	
H	.736	.752	18.70	19.10
L	.094	.106	2.40	2.70
L ₁	.047	.055	1.20	1.40
L ₂	.039	.045	1.00	1.15
L ₃	.010 BSC		0.25 BSC	
L ₄	.150	.161	3.80	4.10

Fig. 1. Output Characteristics @ $T_J = 25^\circ\text{C}$

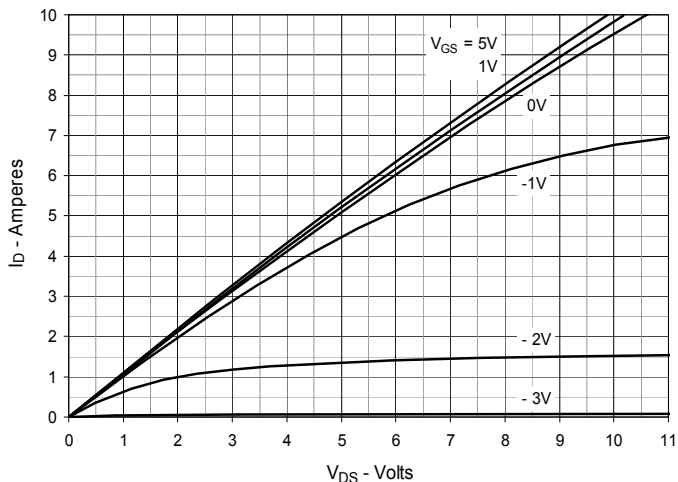

Fig. 2. Extended Output Characteristics @ $T_J = 25^\circ\text{C}$

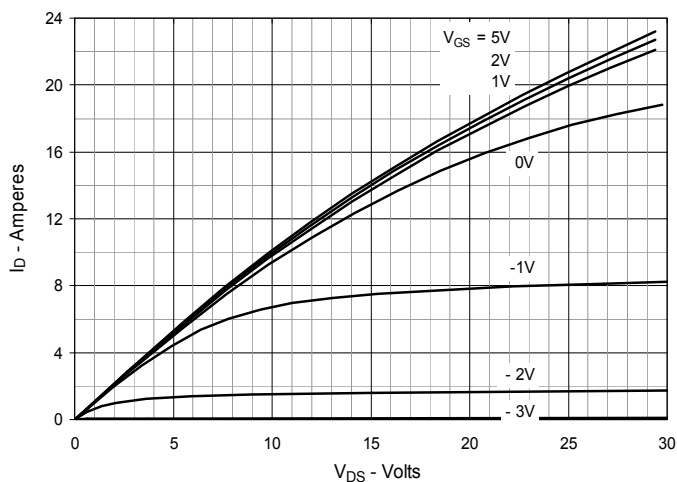

Fig. 3. Output Characteristics @ $T_J = 125^\circ\text{C}$

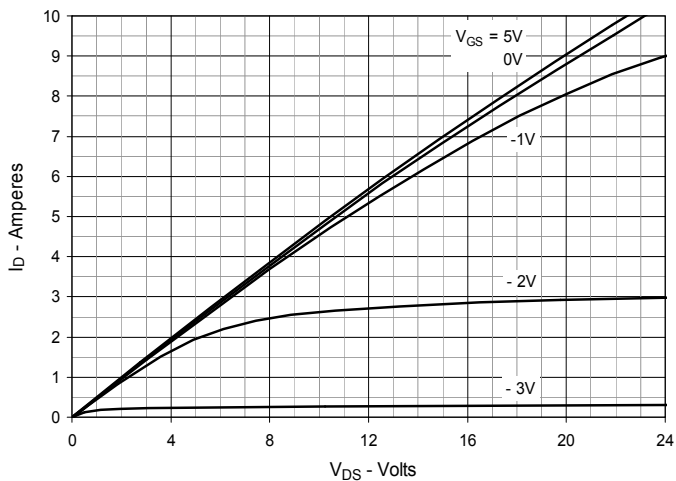

Fig. 4. Drain Current @ $T_J = 25^\circ\text{C}$

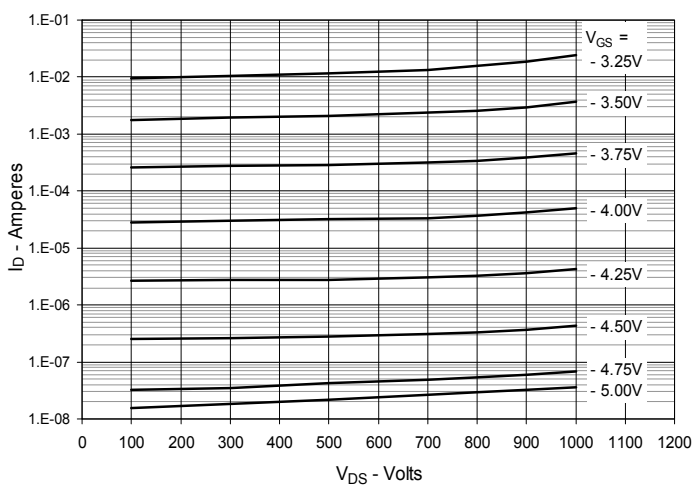

Fig. 5. Drain Current @ $T_J = 100^\circ\text{C}$

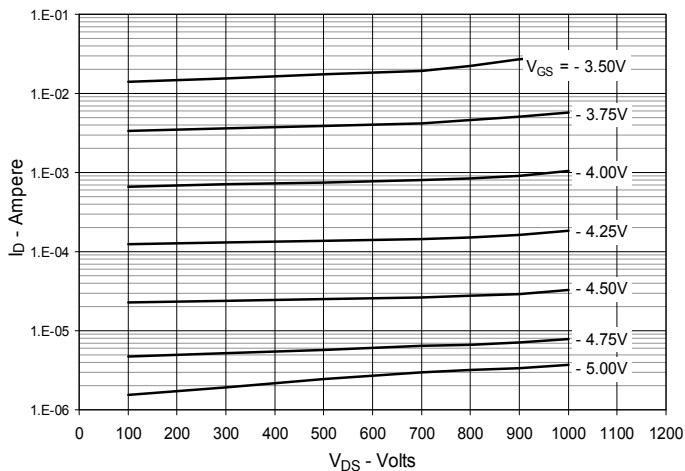

Fig. 6. Dynamic Resistance vs. Gate Voltage

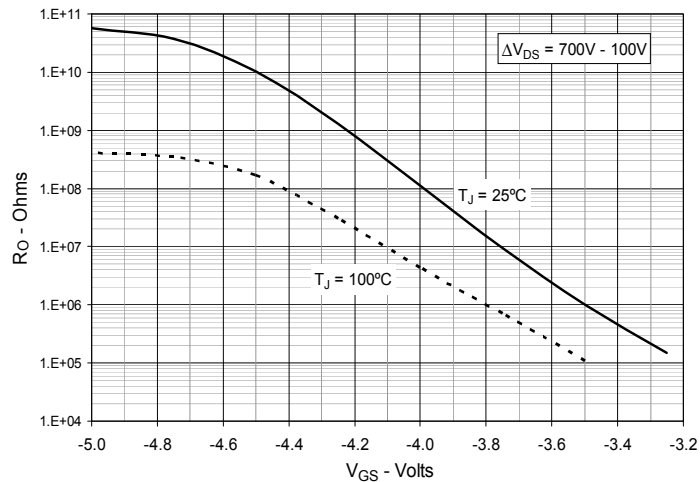

Fig. 7. Normalized $R_{DS(on)}$ vs. Junction Temperature

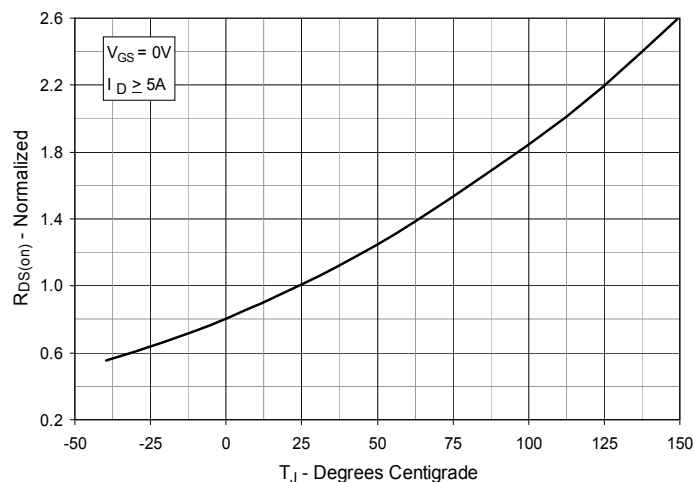

Fig. 8. $R_{DS(on)}$ Normalized to $I_D = 5A$ Value vs. Drain Current

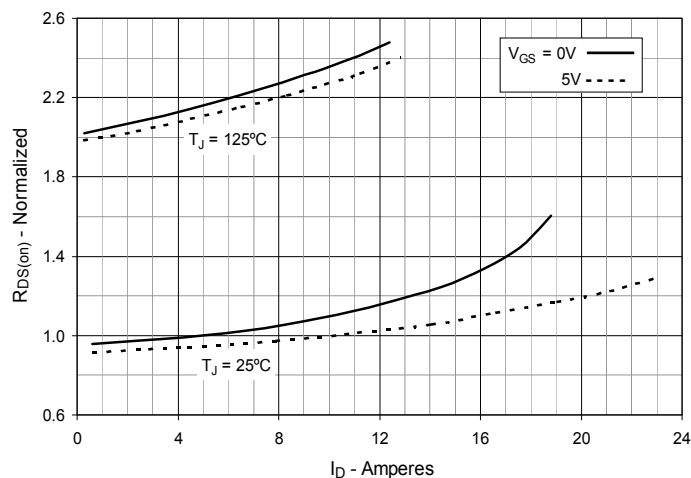

Fig. 9. Input Admittance

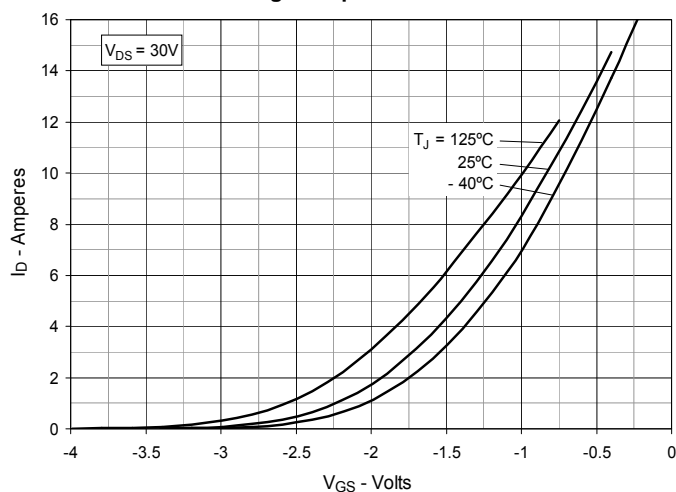

Fig. 10. Transconductance

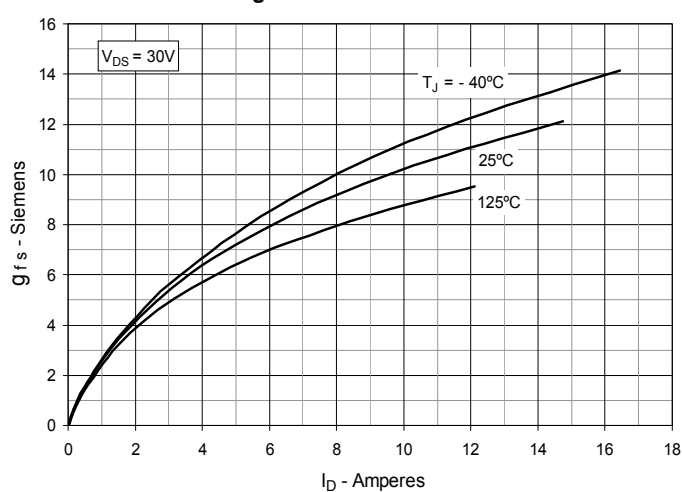

Fig. 11. Normalized Breakdown and Threshold Voltages vs. Junction Temperature

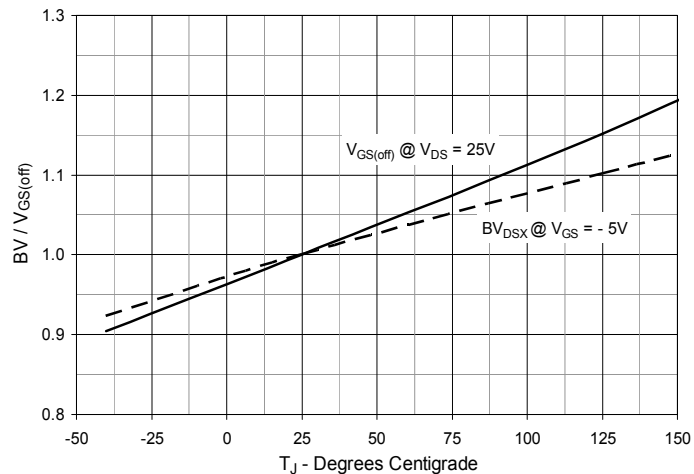

Fig. 12. Forward Voltage Drop of Intrinsic Diode

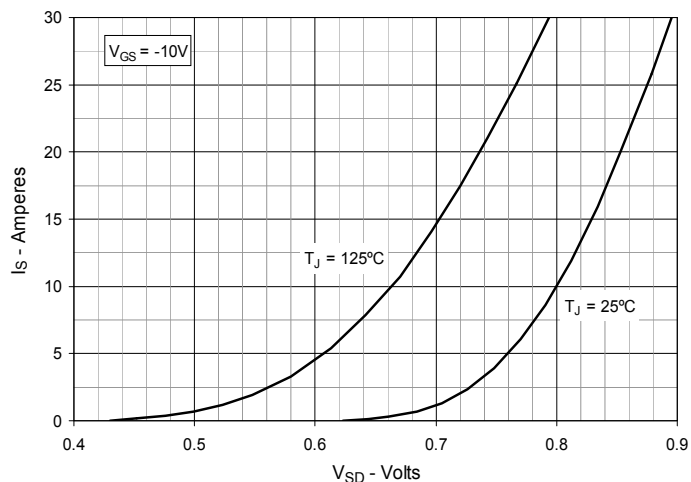

Fig. 13. Capacitance

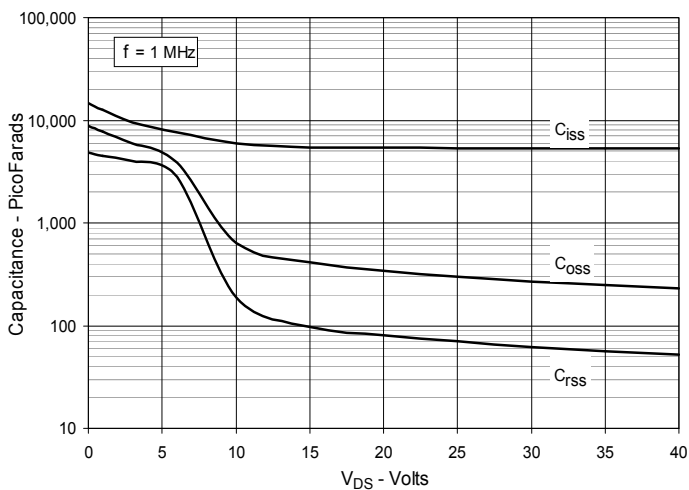
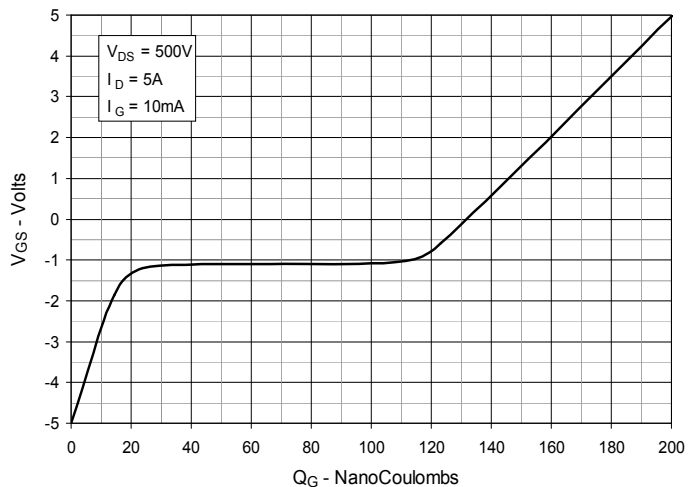
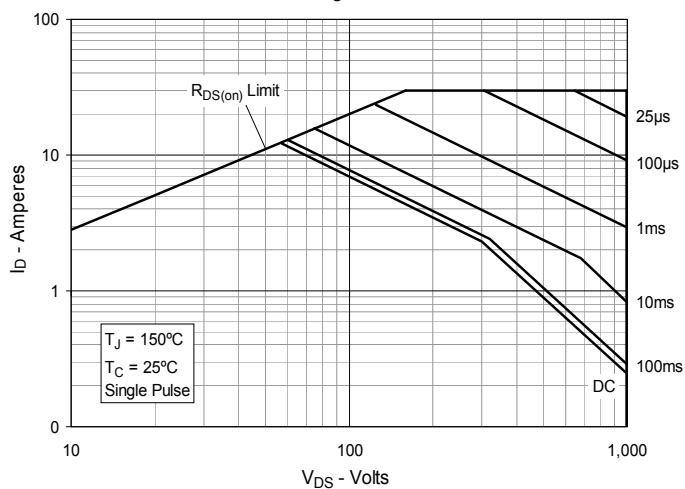

Fig. 14. Gate Charge



**Fig. 15. Forward-Bias Safe Operating Area
@ $T_C = 25^\circ\text{C}$**



**Fig. 16. Forward-Bias Safe Operating Area
@ $T_C = 75^\circ\text{C}$**

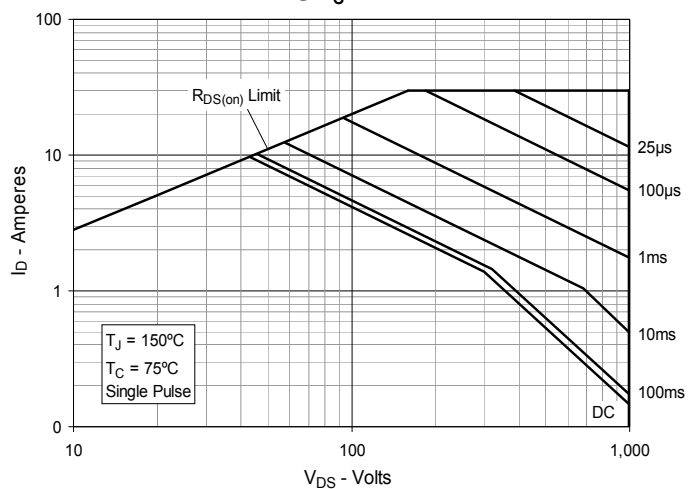
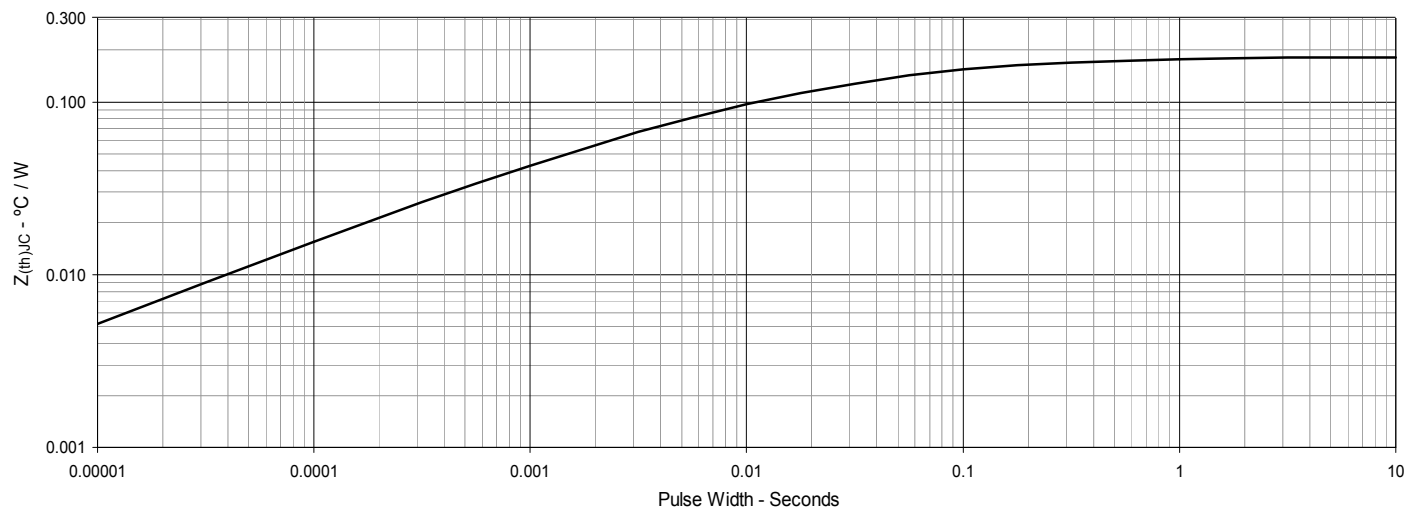

Fig. 17. Maximum Transient Thermal Impedance



Mouser Electronics

Authorized Distributor

Click to View Pricing, Inventory, Delivery & Lifecycle Information:

[IXYS:](#)

[IXTT12N140](#) [IXTT10N100D2](#)