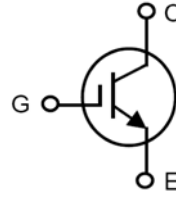

XPT™ 650V IGBT
GenX4™
IXXH60N65C4

 Extreme Light Punch Through
 IGBT for 20-60 kHz Switching

$$V_{CES} = 650V$$

$$I_{C110} = 60A$$

$$V_{CE(sat)} \leq 2.4V$$

$$t_{fi(typ)} = 30ns$$

Symbol	Test Conditions	Maximum Ratings	
V_{CES}	$T_J = 25^\circ C$ to $175^\circ C$	650	V
V_{CGR}	$T_J = 25^\circ C$ to $175^\circ C$, $R_{GE} = 1M\Omega$	650	V
V_{GES}	Continuous	± 20	V
V_{GEM}	Transient	± 30	V
I_{C25}	$T_C = 25^\circ C$ (Chip Capability)	118	A
I_{C110}	$T_C = 110^\circ C$	60	A
I_{CM}	$T_C = 25^\circ C$, 1ms	240	A
SSOA (RBSOA)	$V_{GE} = 15V$, $T_{VJ} = 150^\circ C$, $R_G = 5\Omega$ Clamped Inductive Load	$I_{CM} = 120$ @ $V_{CE} \leq V_{CES}$	A
t_{sc} (SCSOA)	$V_{GE} = 15V$, $V_{CE} = 360V$, $T_J = 150^\circ C$ $R_G = 82\Omega$, Non Repetitive	10	μs
P_C	$T_C = 25^\circ C$	455	W
T_J		-55 ... +175	$^\circ C$
T_{JM}		175	$^\circ C$
T_{stg}		-55 ... +175	$^\circ C$
T_L	Maximum Lead Temperature for Soldering	300	$^\circ C$
T_{SOLD}	1.6 mm (0.062in.) from Case for 10s	260	$^\circ C$
M_d	Mounting Torque	1.13/10	Nm/lb.in
Weight		6	g

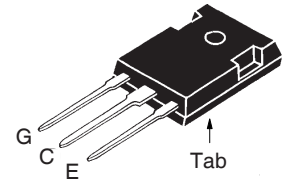
TO-247

G = Gate C = Collector
 E = Emitter Tab = Collector

Features

- Optimized for 20-60kHz Switching
- Square RBSOA
- Short Circuit Capability
- International Standard Package

Advantages

- High Power Density
- 175 $^\circ C$ Rated
- Extremely Rugged
- Low Gate Drive Requirement

Applications

- Power Inverters
- UPS
- Motor Drives
- SMPS
- PFC Circuits
- Battery Chargers
- Welding Machines
- Lamp Ballasts
- High Frequency Power Inverters

Symbol	Test Conditions ($T_J = 25^\circ C$, Unless Otherwise Specified)	Characteristic Values		
		Min.	Typ.	Max.
BV_{CES}	$I_C = 250\mu A$, $V_{GE} = 0V$	650		V
$V_{GE(th)}$	$I_C = 250\mu A$, $V_{CE} = V_{GE}$	4.0		6.5 V
I_{CES}	$V_{CE} = V_{CES}$, $V_{GE} = 0V$ $T_J = 150^\circ C$			10 μA 750 μA
I_{GES}	$V_{CE} = 0V$, $V_{GE} = \pm 20V$			± 100 nA
$V_{CE(sat)}$	$I_C = 60A$, $V_{GE} = 15V$, Note 1 $T_J = 150^\circ C$		1.8 2.3	2.4 V V

Symbol Test Conditions ($T_J = 25^\circ\text{C}$ Unless Otherwise Specified)		Characteristic Values		
		Min.	Typ.	Max.
g_{fs}	$I_C = 60\text{A}, V_{CE} = 10\text{V}$, Note 1	15	24	S
C_{ies}	$V_{CE} = 25\text{V}, V_{GE} = 0\text{V}, f = 1\text{MHz}$		1870	pF
C_{oes}			125	pF
C_{res}			70	pF
$Q_{g(on)}$	$I_C = 60\text{A}, V_{GE} = 15\text{V}, V_{CE} = 0.5 \cdot V_{CES}$		94	nC
Q_{ge}			15	nC
Q_{gc}			40	nC
$t_{d(on)}$	Inductive load, $T_J = 25^\circ\text{C}$ $I_C = 60\text{A}, V_{GE} = 15\text{V}$ $V_{CE} = 400\text{V}, R_G = 5\Omega$ Note 2		37	ns
t_{ri}			78	ns
E_{on}			3.20	mJ
$t_{d(off)}$			133	ns
t_{fi}			30	ns
E_{off}			0.83	1.40 mJ
$t_{d(on)}$	Inductive load, $T_J = 150^\circ\text{C}$ $I_C = 60\text{A}, V_{GE} = 15\text{V}$ $V_{CE} = 400\text{V}, R_G = 5\Omega$ Note 2		32	ns
t_{ri}			70	ns
E_{on}			3.42	mJ
$t_{d(off)}$			110	ns
t_{fi}			47	ns
E_{off}			0.93	mJ
R_{thJC}			0.33	$^\circ\text{C/W}$
R_{thCS}		0.21		$^\circ\text{C/W}$

TO-247 (IXXH) Outline

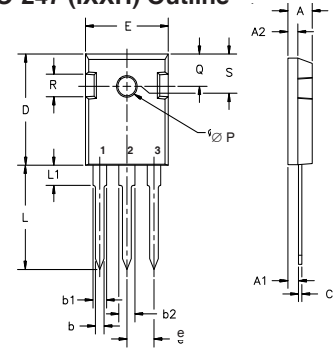

Terminals: 1 - Gate 2 - Collector
3 - Emitter

Dim.	Millimeter		Inches	
	Min.	Max.	Min.	Max.
A	4.7	5.3	.185	.209
A ₁	2.2	2.54	.087	.102
A ₂	2.2	2.6	.059	.098
b	1.0	1.4	.040	.055
b ₁	1.65	2.13	.065	.084
b ₂	2.87	3.12	.113	.123
C	.4	.8	.016	.031
D	20.80	21.46	.819	.845
E	15.75	16.26	.610	.640
e	5.20	5.72	0.205	0.225
L	19.81	20.32	.780	.800
L1		4.50		.177
∅P	3.55	3.65	.140	.144
Q	5.89	6.40	0.232	0.252
R	4.32	5.49	.170	.216
S	6.15	BSC	.242	BSC

Notes:

1. Pulse test, $t \leq 300\mu\text{s}$, duty cycle, $d \leq 2\%$.
2. Switching times & energy losses may increase for higher V_{CE} (clamp), T_J or R_G .

PRELIMINARY TECHNICAL INFORMATION

The product presented herein is under development. The Technical Specifications offered are derived from data gathered during objective characterizations of preliminary engineering lots; but also may yet contain some information supplied during a pre-production design evaluation. IXYS reserves the right to change limits, test conditions, and dimensions without notice.

IXYS Reserves the Right to Change Limits, Test Conditions, and Dimensions.

IXYS MOSFETs and IGBTs are covered by one or more of the following U.S. patents:	4,835,592	4,931,844	5,049,961	5,237,481	6,162,665	6,404,065 B1	6,683,344	6,727,585	7,005,734 B2	7,157,338B2
	4,860,072	5,017,508	5,063,307	5,381,025	6,259,123 B1	6,534,343	6,710,405 B2	6,759,692	7,063,975 B2	
	4,881,106	5,034,796	5,187,117	5,486,715	6,306,728 B1	6,583,505	6,710,463	6,771,478 B2	7,071,537	

Fig. 1. Output Characteristics @ $T_J = 25^\circ\text{C}$

Fig. 2. Extended Output Characteristics @ $T_J = 25^\circ\text{C}$

Fig. 3. Output Characteristics @ $T_J = 150^\circ\text{C}$

Fig. 4. Dependence of $V_{CE(sat)}$ on Junction Temperature

Fig. 5. Collector-to-Emitter Voltage vs. Gate-to-Emitter Voltage

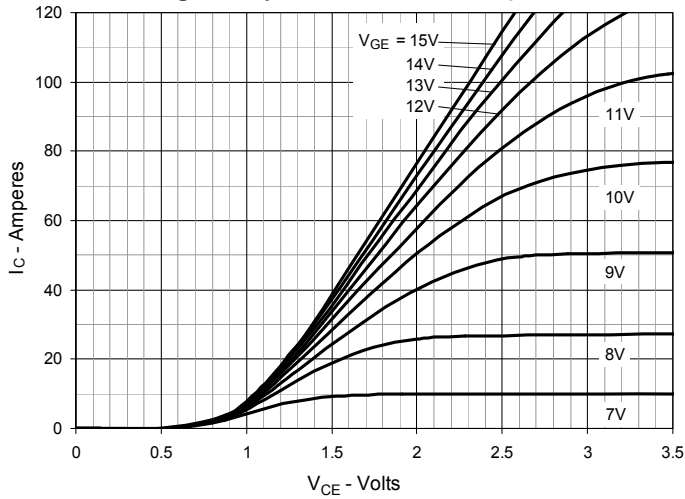
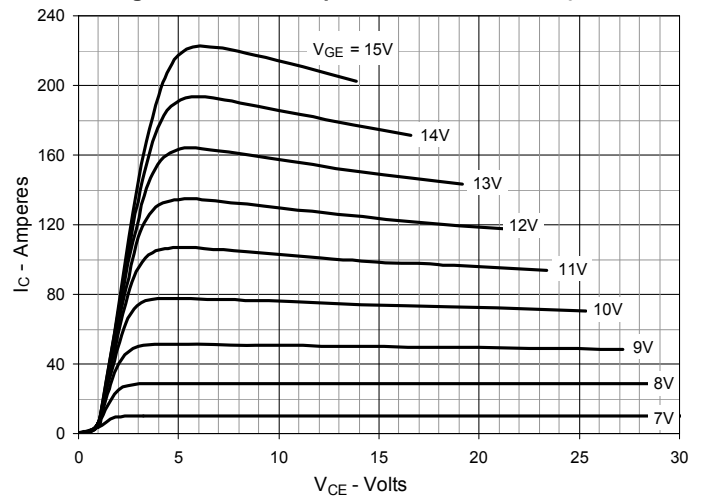
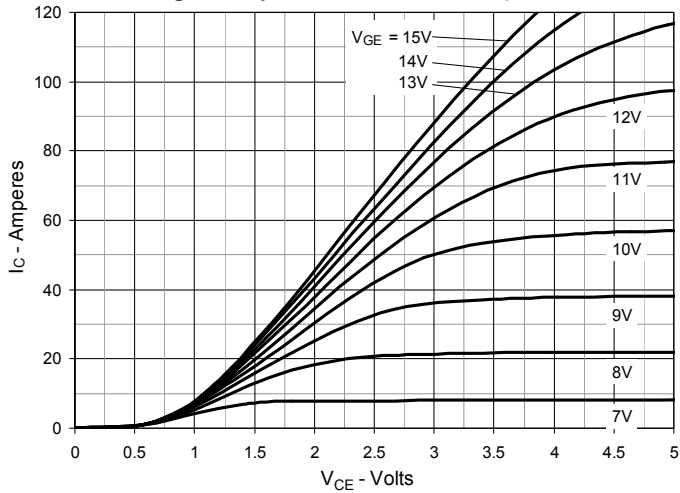
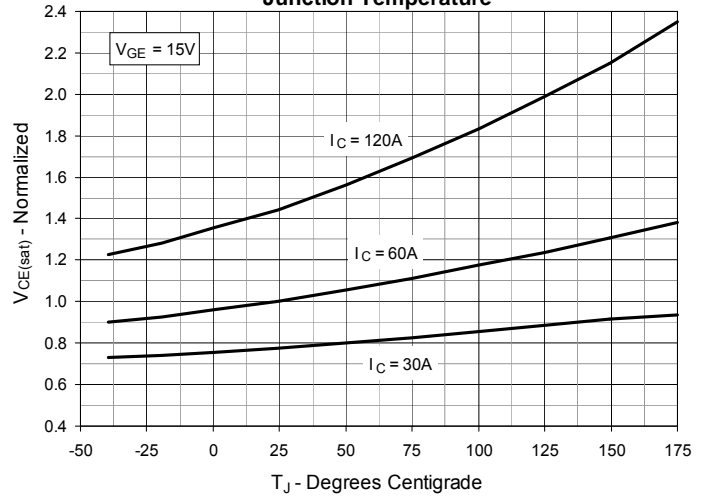
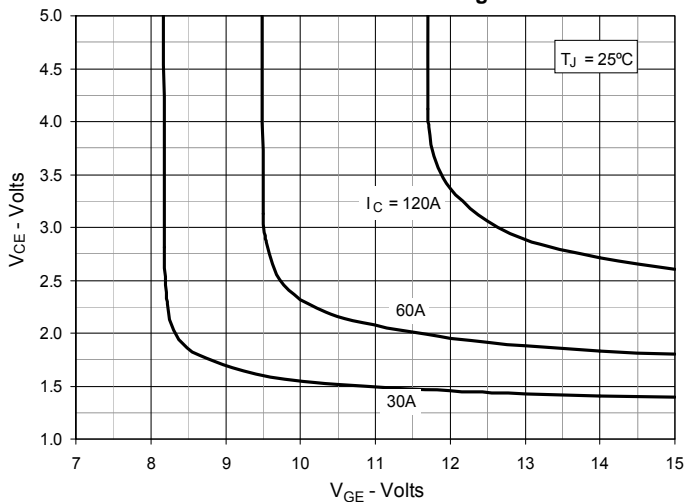
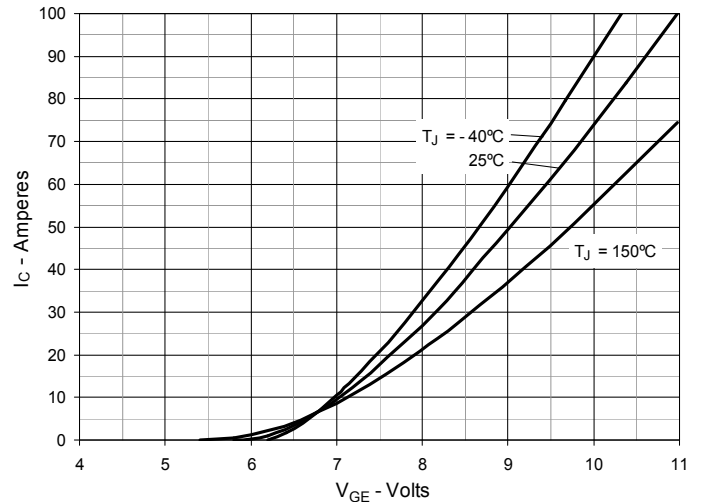
Fig. 6. Input Admittance

Fig. 7. Transconductance

Fig. 8. Gate Charge

Fig. 9. Capacitance

Fig. 10. Reverse-Bias Safe Operating Area

Fig. 11. Maximum Transient Thermal Impedance

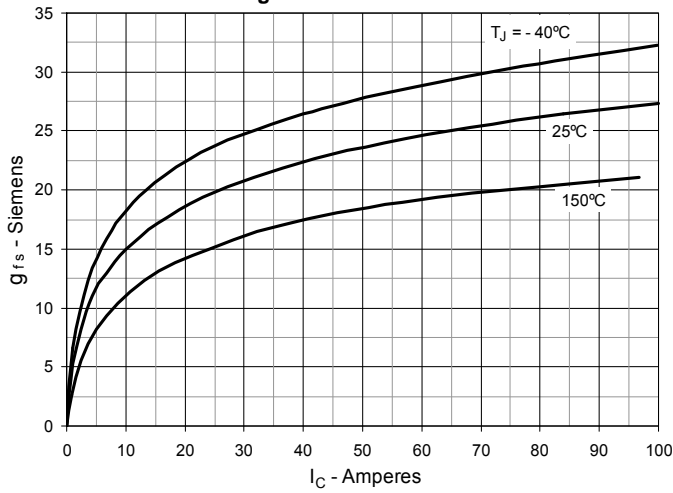
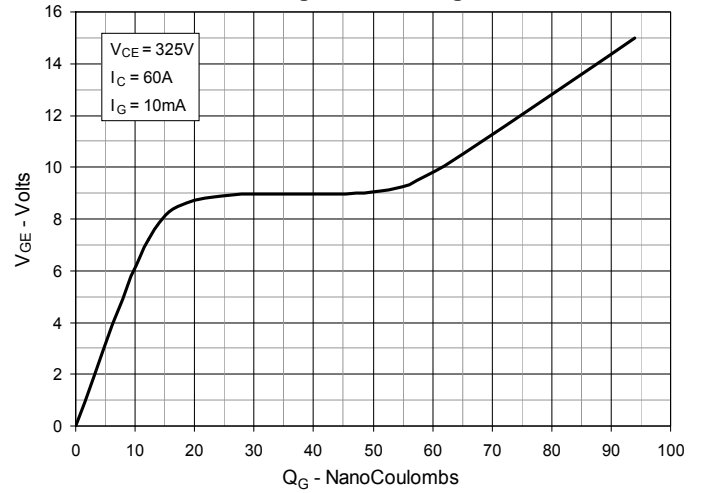
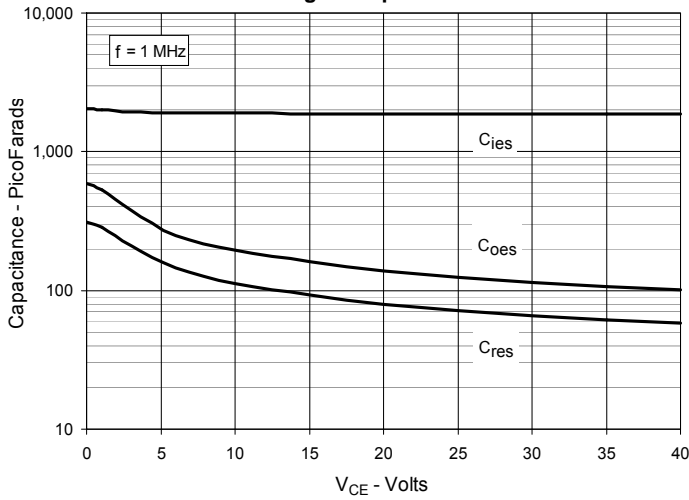
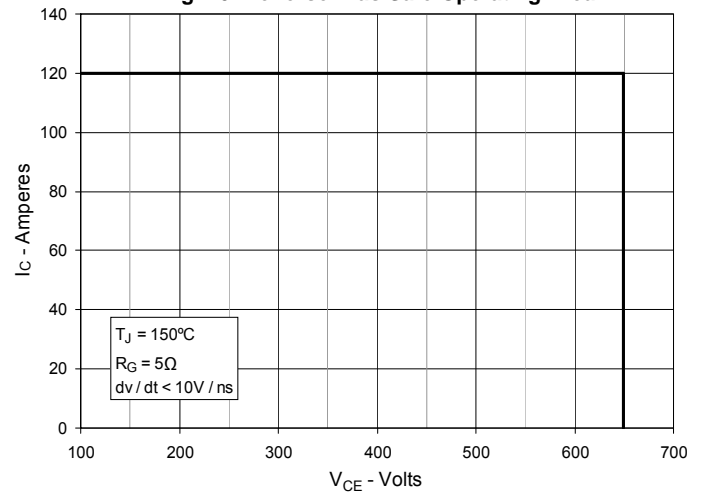
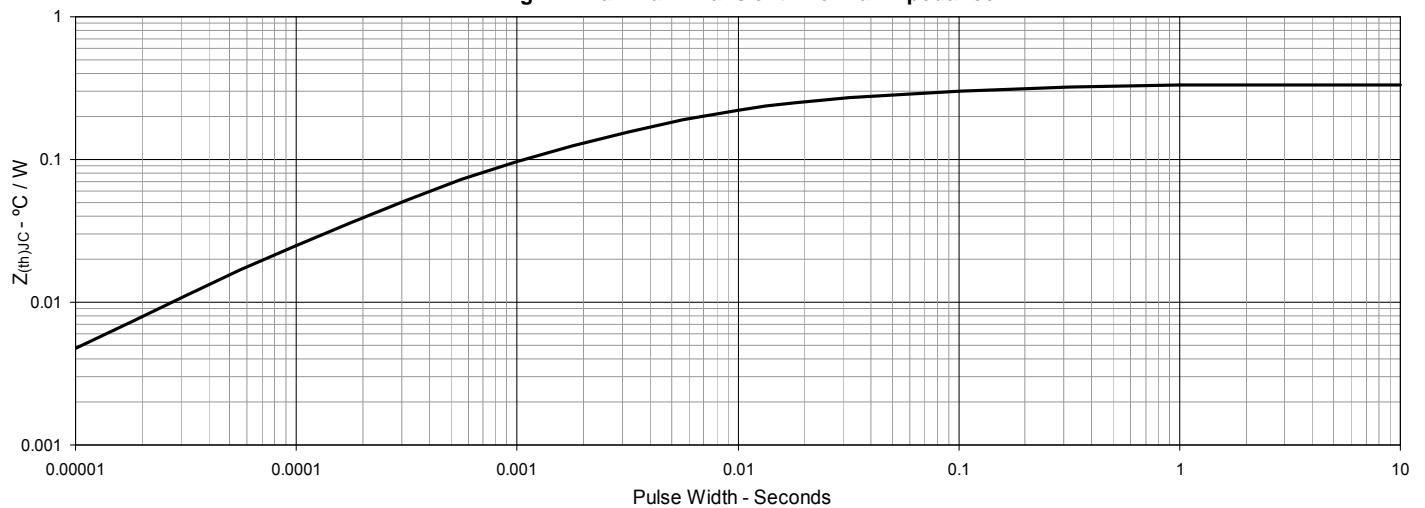
Fig. 12. Inductive Switching Energy Loss vs. Gate Resistance

Fig. 13. Inductive Switching Energy Loss vs. Collector Current

Fig. 14. Inductive Switching Energy Loss vs. Junction Temperature

Fig. 15. Inductive Turn-off Switching Times vs. Gate Resistance

Fig. 16. Inductive Turn-off Switching Times vs. Collector Current

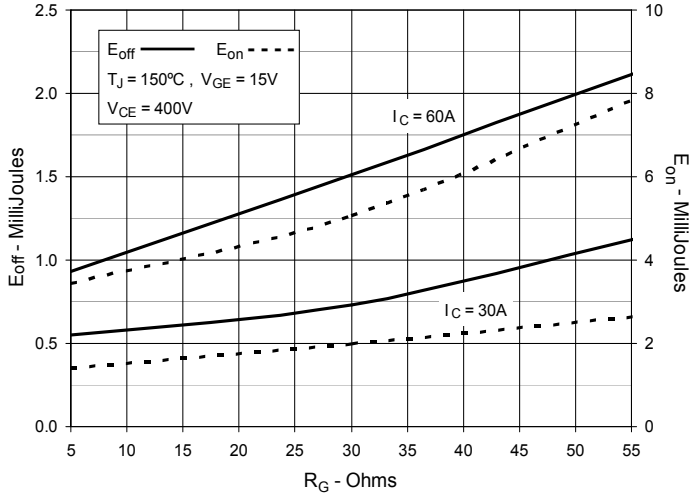
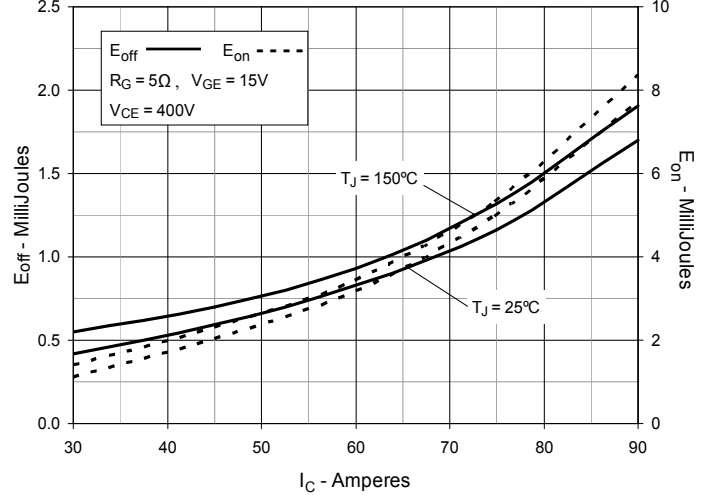
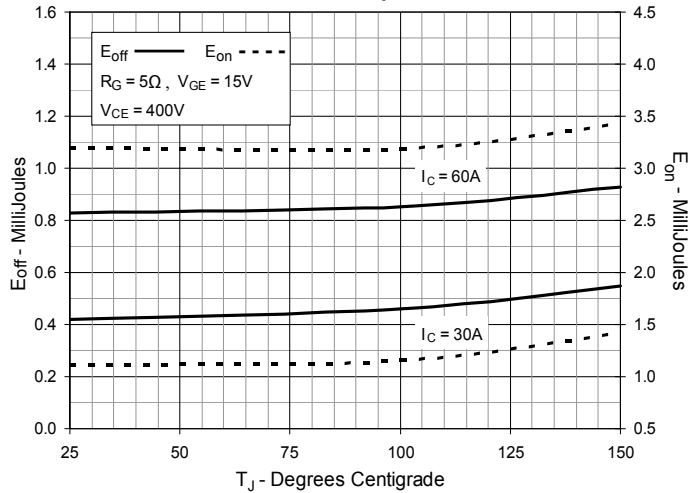
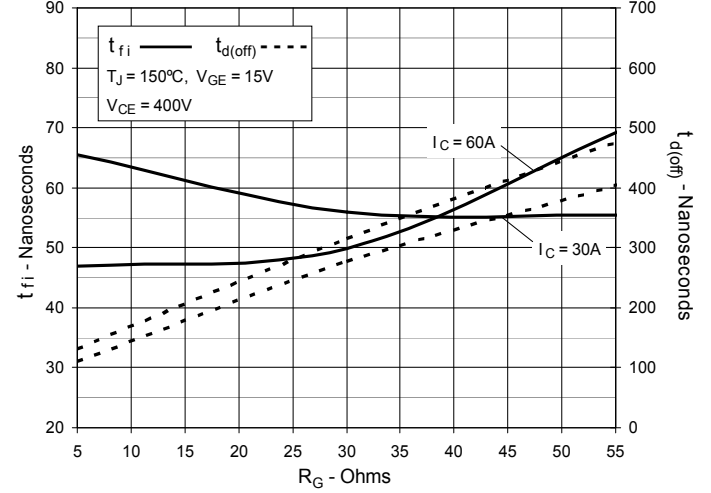
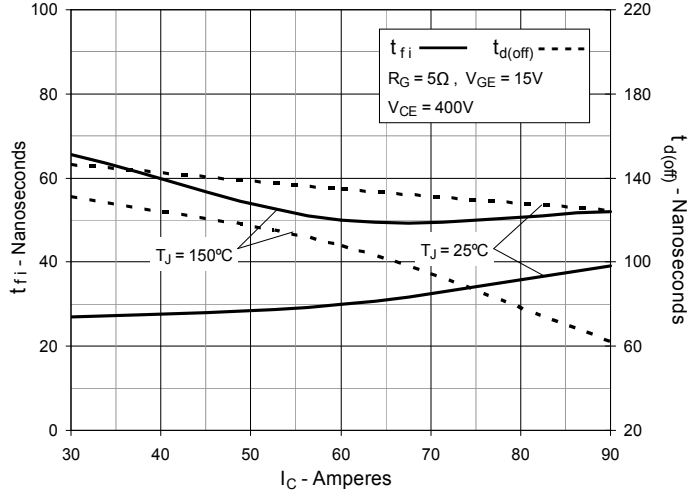
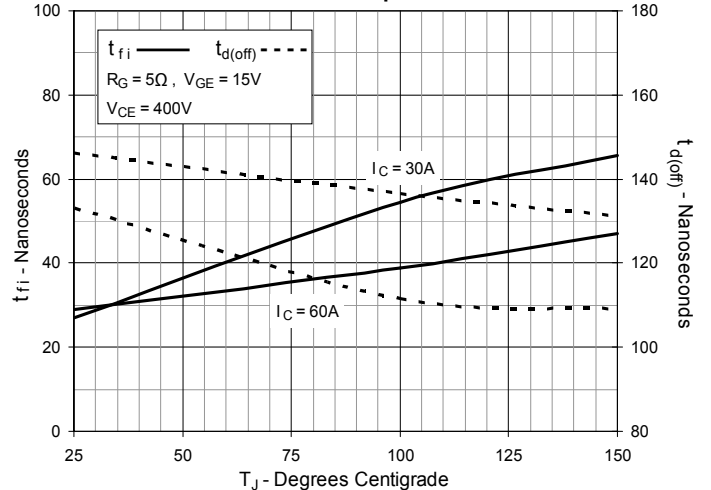
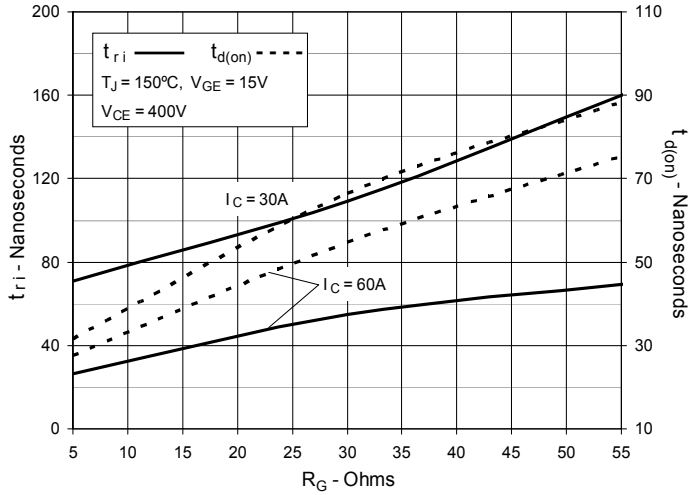
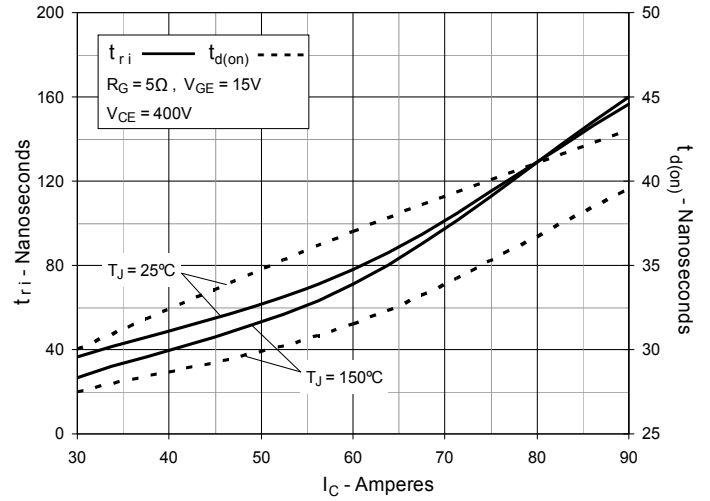
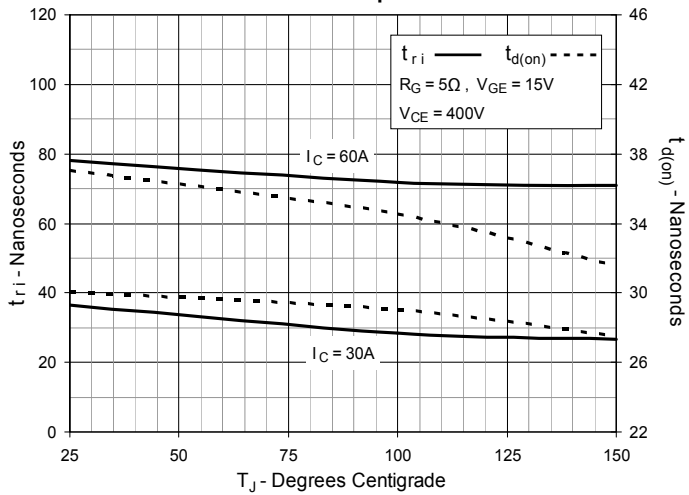
Fig. 17. Inductive Turn-off Switching Times vs. Junction Temperature

Fig. 18. Inductive Turn-on Switching Times vs. Gate Resistance

Fig. 19. Inductive Turn-on Switching Times vs. Collector Current

Fig. 20. Inductive Turn-on Switching Times vs. Junction Temperature

Mouser Electronics

Authorized Distributor

Click to View Pricing, Inventory, Delivery & Lifecycle Information:

[IXYS:](#)

[IXXH60N65C4](#)