

# CoolMOS™ 1) Power MOSFET

Electrically isolated back surface  
 2500 V electrical isolation  
 N-Channel Enhancement Mode  
 Low  $R_{DS(on)}$ , high  $V_{DSS}$  MOSFET  
 Ultra low gate charge

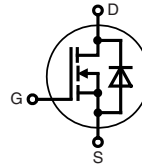
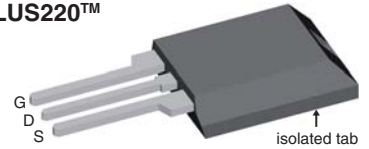

$V_{DSS} = 600\text{ V}$   
 $I_{D25} = 28\text{ A}$   
 $R_{DS(on) \text{ max}} = 95\text{ m}\Omega$

**ISOPLUS220™**

E72873

MOSFET			
Symbol	Conditions	Maximum Ratings	
$V_{DSS}$	$T_{VJ} = 25^\circ\text{C}$	600	V
$V_{GS}$		$\pm 20$	V
$I_{D25}$	$T_C = 25^\circ\text{C}$	28	A
$I_{D90}$	$T_C = 90^\circ\text{C}$	19.2	A
$E_{AS}$	single pulse; $I_D = 10\text{ A}$ ; $T_C = 25^\circ\text{C}$	690	mJ
$E_{AR}$	repetitive; $I_D = 20\text{ A}$ ; $T_C = 25^\circ\text{C}$	1	mJ

**Features**

- Silicon chip on Direct-Copper-Bond substrate
  - high power dissipation
  - isolated mounting surface
  - 2500 V electrical isolation
  - low drain to tab capacitance ( $< 30\text{ pF}$ )
- CoolMOS™ 1) power MOSFET
  - 3rd generation
  - high blocking capability
  - lowest resistance
  - avalanche rated for unclamped inductive switching (UIS)
  - low thermal resistance due to reduced chip thickness
- Enhanced total power density

Symbol	Conditions	Characteristic Values			
		$(T_{VJ} = 25^\circ\text{C}, \text{ unless otherwise specified})$			
		min.	typ.	max.	
$R_{DS(on)}$	$V_{GS} = 10\text{ V}$ ; $I_D = 28\text{ A}$		80	95	m $\Omega$
$V_{GS(th)}$	$V_{DS} = V_{GS}$ ; $I_D = 2\text{ mA}$	2.1		3.9	V
$I_{DSS}$	$V_{DS} = 600\text{ V}$ ; $V_{GS} = 0\text{ V}$			50	$\mu\text{A}$
				500	$\mu\text{A}$
$I_{GSS}$	$V_{GS} = \pm 20\text{ V}$ ; $V_{DS} = 0\text{ V}$			200	nA
$C_{iss}$	} $V_{GS} = 0\text{ V}$ ; $V_{DS} = 25\text{ V}$ $f = 1\text{ MHz}$		4800		pF
$C_{oss}$				1560	
$Q_g$	} $V_{GS} = 0\text{ to }10\text{ V}$ ; $V_{DS} = 350\text{ V}$ ; $I_D = 40\text{ A}$		175	230	nC
$Q_{gs}$			22		nC
$Q_{gd}$			66		nC
$t_{d(on)}$	} $V_{GS} = 13\text{ V}$ ; $V_{DS} = 380\text{ V}$ $I_D = 40\text{ A}$ ; $R_G = 1.5\ \Omega$ ; $T_{VJ} = 125^\circ\text{C}$		10		ns
$t_r$			5		ns
$t_{d(off)}$			67		ns
$t_f$			4.5		ns
$R_{thJC}$				0.6	K/W

**Applications**

- Switched mode power supplies (SMPS)
- Uninterruptible power supplies (UPS)
- Power factor correction (PFC)
- Welding
- Inductive heating
- PDP and LCD adapter

**Advantages**

- Easy assembly: no screws or isolation foils required
- Space savings
- High power density
- High reliability

<sup>1)</sup> CoolMOS™ is a trademark of Infineon Technologies AG.

**Source-Drain Diode**

Symbol	Conditions	Characteristic Values			
		min.	typ.	max.	
( $T_{VJ} = 25^{\circ}\text{C}$ , unless otherwise specified)					
$I_S$	$V_{GS} = 0\text{ V}$			40	A
$V_{SD}$	$I_F = 32\text{ A}; V_{GS} = 0\text{ V}$		0.9	1.2	V
$t_{rr}$	$I_F = 40\text{ A}; -di_F/dt = 200\text{ A}/\mu\text{s}; V_R = 480\text{ V}$		500	800	ns
$Q_{RM}$			20		$\mu\text{C}$
$I_{RM}$			140		A

**Component**

Symbol	Conditions	Maximum Ratings	
$T_{VJ}$	operating	-55...+150	$^{\circ}\text{C}$
$T_{stg}$	storage	-55...+150	$^{\circ}\text{C}$
$V_{ISOL}$	RMS leads-to-tab, 50/60 Hz, $f = 1$ minute	2500	V~
$F_c$	mounting force	11-65 / 2.4-11	N/lb

Symbol	Conditions	Characteristic Values		
		min.	typ.	max.
$R_{thCH}$	with heatsink compound		0.2	K/W
<b>Weight</b>			2.7	g

## ISOPLUS220™ Outline

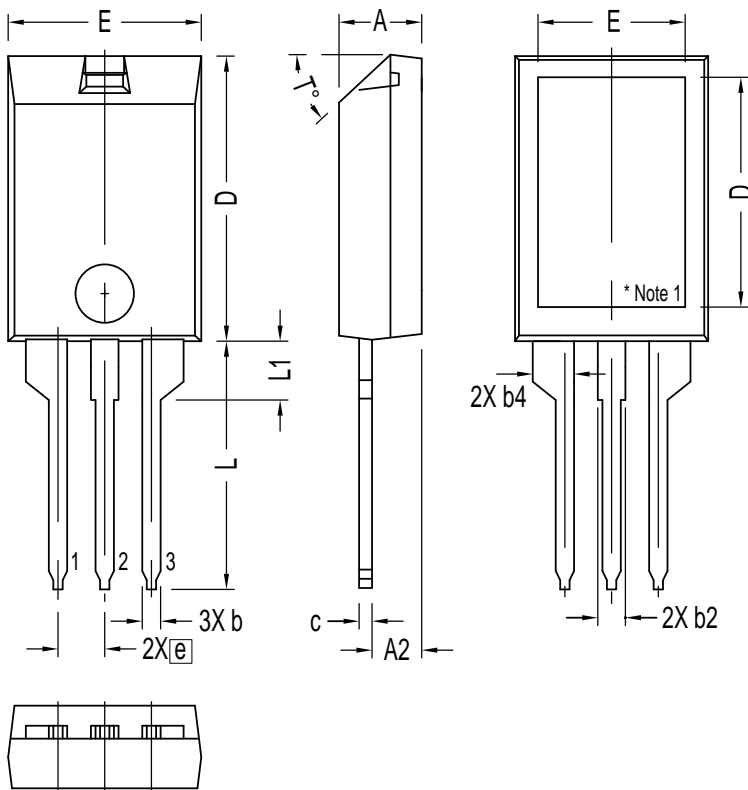

SYM	INCHES		MILLIMETERS	
	MIN	MAX	MIN	MAX
A	.157	.197	4.00	5.00
A2	.098	.118	2.50	3.00
b	.035	.051	0.90	1.30
b2	.049	.065	1.25	1.65
b4	.093	.100	2.35	2.55
c	.028	.039	0.70	1.00
D	.591	.630	15.00	16.00
D1	.472	.512	12.00	13.00
E	.394	.433	10.00	11.00
E1	.295	.335	7.50	8.50
e	.100 BASIC		2.55	BASIC
L	.512	.571	13.00	14.50
L1	.118	.138	3.00	3.50
T°			42.5°	47.5°

NOTE:  
 1. Bottom heatsink is electrically isolated from Pin 1, 2, or 3.  
 2. This drawing will meet dimensional requirement of JEDEC SS Product Outline TO-273 except D and D1 dimension.

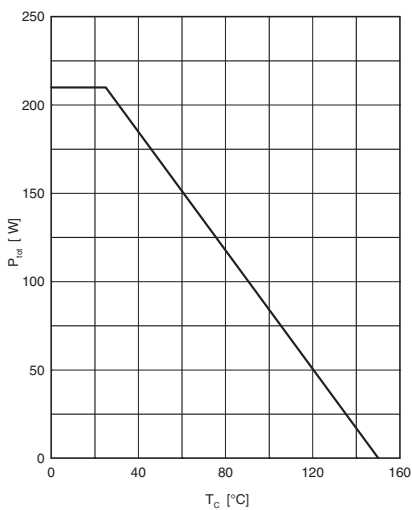

Fig. 1 Power dissipation

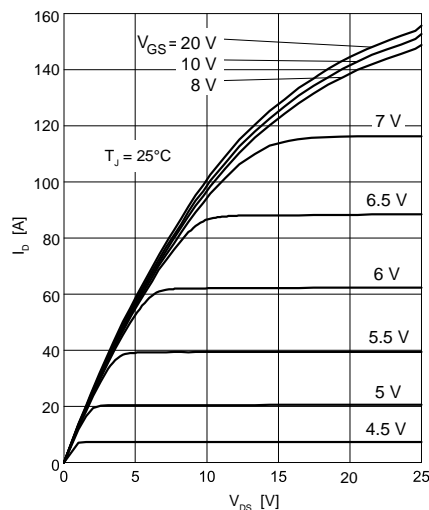

Fig. 2 Typ. output characteristics

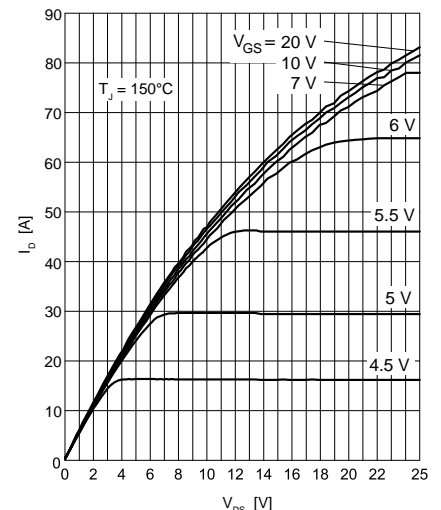

Fig. 3 Typ. output characteristics

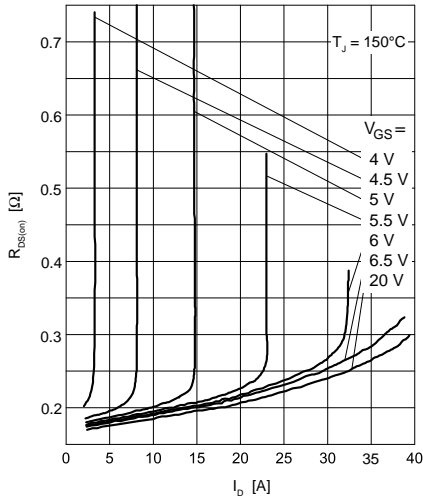

Fig. 4 Typ. drain-source on-state resistance

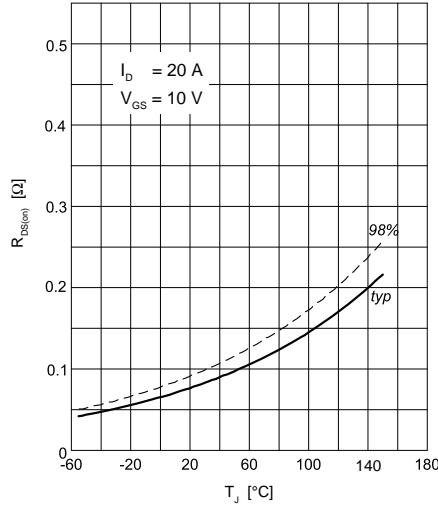

Fig. 5 Drain-source on-state resistance

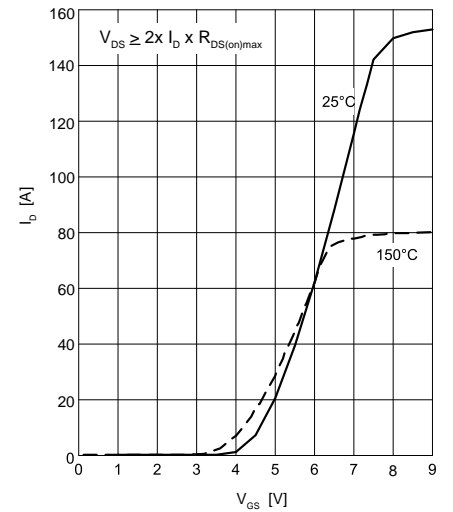

Fig. 6 Typ. transfer characteristics

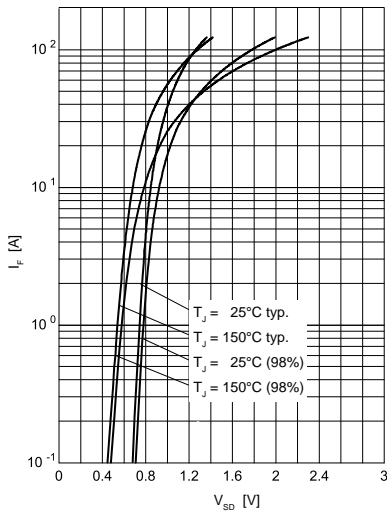

Fig. 7 Forward characteristic of reverse diode

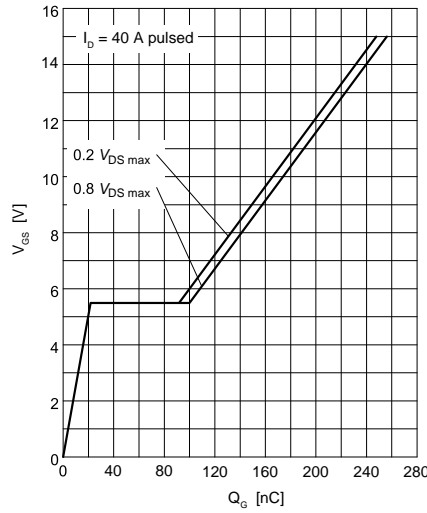

Fig. 8 Typ. gate charge

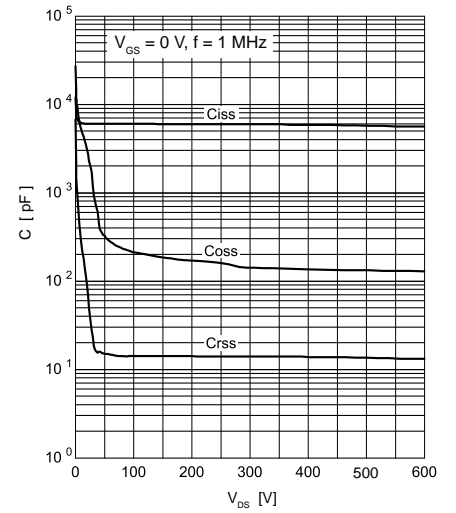

Fig. 9 Typ. capacitances

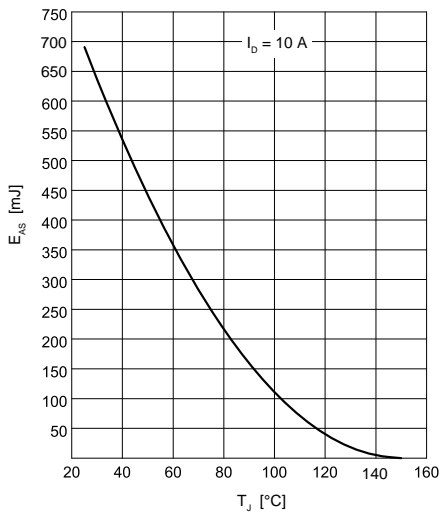

Fig. 10 Avalanche energy

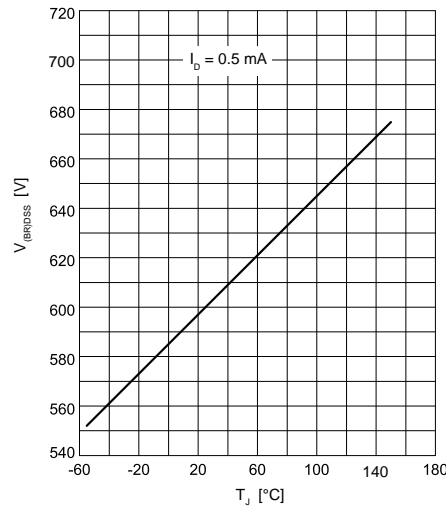

Fig. 11 Drain-source breakdown voltage

# Mouser Electronics

Authorized Distributor

Click to View Pricing, Inventory, Delivery & Lifecycle Information:

[IXYS:](#)

[IXKC40N60C](#)