

## Standard Rectifier Module

<b>3~ Rectifier</b>	
$V_{RRM}$	= 1600 V
$I_{DAV}$	= 27 A
$I_{FSM}$	= 550 A

### 3~ Rectifier Bridge

Part number

VUO36-16NO8

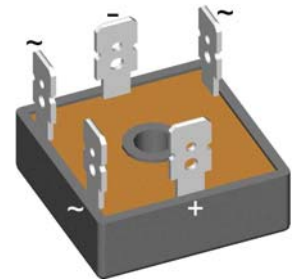

 E72873

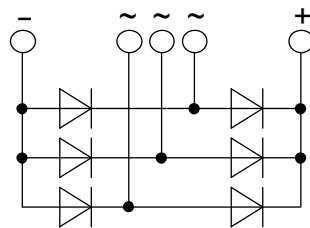

#### Features / Advantages:

- Planar passivated chips
- Very low leakage current
- Very low forward voltage drop
- Improved thermal behaviour

#### Applications:

- Diode for main rectification
- For three phase bridge configurations
- Supplies for DC power equipment
- Input rectifiers for PWM inverter
- Battery DC power supplies
- Field supply for DC motors

#### Package: FO-B

- Industry standard outline
- RoHS compliant
- ¼" fast-on terminals
- Easy to mount with one screw

Rectifier				Ratings		
Symbol	Definition	Conditions	min.	typ.	max.	Unit
$V_{RSM}$	max. non-repetitive reverse blocking voltage	$T_{VJ} = 25^{\circ}C$			1700	V
$V_{RRM}$	max. repetitive reverse blocking voltage	$T_{VJ} = 25^{\circ}C$			1600	V
$I_R$	reverse current	$V_R = 1600 V$	$T_{VJ} = 25^{\circ}C$		40	$\mu A$
		$V_R = 1600 V$	$T_{VJ} = 150^{\circ}C$		1.5	mA
$V_F$	forward voltage drop	$I_F = 15 A$	$T_{VJ} = 25^{\circ}C$		1.04	V
		$I_F = 45 A$			1.23	V
		$I_F = 15 A$	$T_{VJ} = 125^{\circ}C$		0.93	V
		$I_F = 45 A$			1.18	V
$I_{DAV}$	bridge output current	$T_C = 85^{\circ}C$ rectangular $d = \frac{1}{3}$	$T_{VJ} = 150^{\circ}C$		27	A
$V_{FO}$	threshold voltage	} for power loss calculation only	$T_{VJ} = 150^{\circ}C$		0.76	V
$r_F$	slope resistance				9.1	m $\Omega$
$R_{thJC}$	thermal resistance junction to case				7	K/W
$R_{thCH}$	thermal resistance case to heatsink			1		K/W
$P_{tot}$	total power dissipation		$T_C = 25^{\circ}C$		17	W
$I_{FSM}$	max. forward surge current	$t = 10 \text{ ms; (50 Hz), sine}$	$T_{VJ} = 45^{\circ}C$		550	A
		$t = 8,3 \text{ ms; (60 Hz), sine}$	$V_R = 0 V$		595	A
		$t = 10 \text{ ms; (50 Hz), sine}$	$T_{VJ} = 150^{\circ}C$		470	A
		$t = 8,3 \text{ ms; (60 Hz), sine}$	$V_R = 0 V$		505	A
$I^2t$	value for fusing	$t = 10 \text{ ms; (50 Hz), sine}$	$T_{VJ} = 45^{\circ}C$		1.52	kA <sup>2</sup> s
		$t = 8,3 \text{ ms; (60 Hz), sine}$	$V_R = 0 V$		1.48	kA <sup>2</sup> s
		$t = 10 \text{ ms; (50 Hz), sine}$	$T_{VJ} = 150^{\circ}C$		1.11	kA <sup>2</sup> s
		$t = 8,3 \text{ ms; (60 Hz), sine}$	$V_R = 0 V$		1.06	kA <sup>2</sup> s
$C_J$	junction capacitance	$V_R = 400 V; f = 1 \text{ MHz}$	$T_{VJ} = 25^{\circ}C$		18	pF

Package FO-B		Ratings				
Symbol	Definition	Conditions	min.	typ.	max.	Unit
$I_{RMS}$	RMS current	per terminal			100	A
$T_{stg}$	storage temperature		-40		125	°C
$T_{VJ}$	virtual junction temperature		-40		150	°C
<b>Weight</b>				20		g
$M_D$	mounting torque		1.8		2.2	Nm
$d_{Spp/App}$	creepage distance on surface   striking distance through air	terminal to terminal	9.0	7.0		mm
$d_{Spb/Apb}$		terminal to backside	10.0	10.0		mm
$V_{ISOL}$	isolation voltage	t = 1 second	3000			V
		t = 1 minute 50/60 Hz, RMS; $I_{ISOL} \leq 1$ mA	2500			V

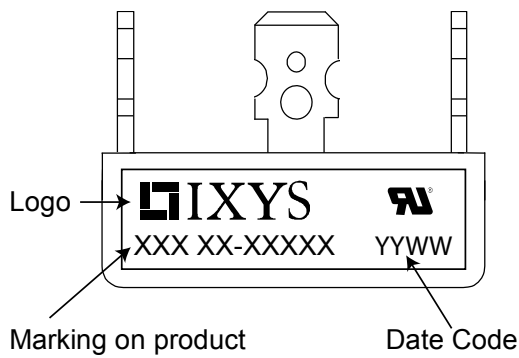

Ordering	Part Number	Marking on Product	Delivery Mode	Quantity	Code No.
Standard	VUO36-16NO8	VUO36-16NO8	Box	50	465178

### Equivalent Circuits for Simulation

\* on die level

$T_{VJ} = 150^\circ\text{C}$

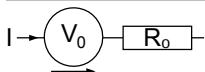

Rectifier

$V_{0\max}$	threshold voltage	0.76	V
$R_{0\max}$	slope resistance *	7.9	mΩ

Outlines FO-B

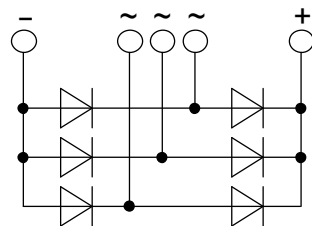
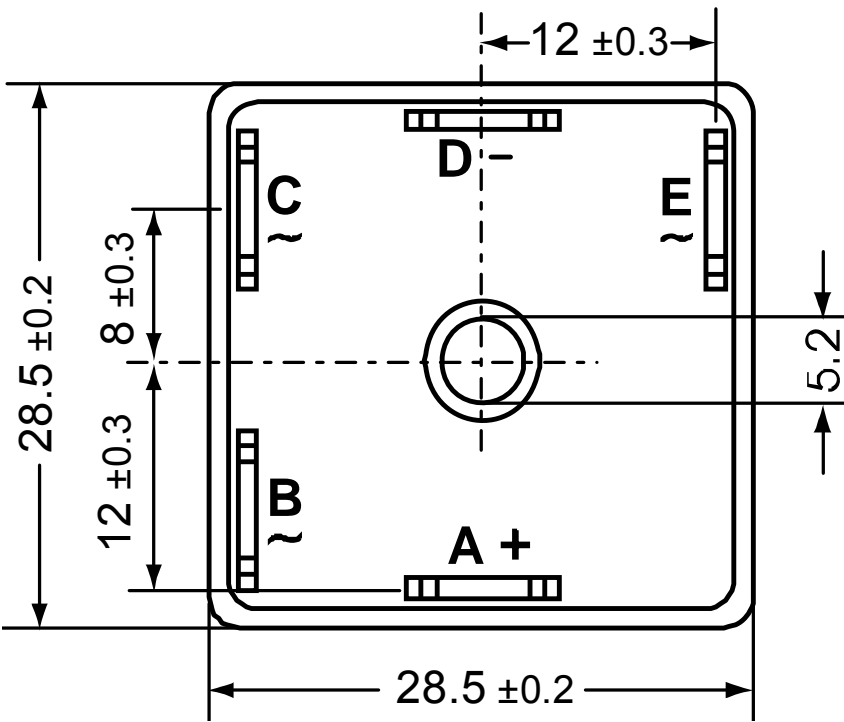
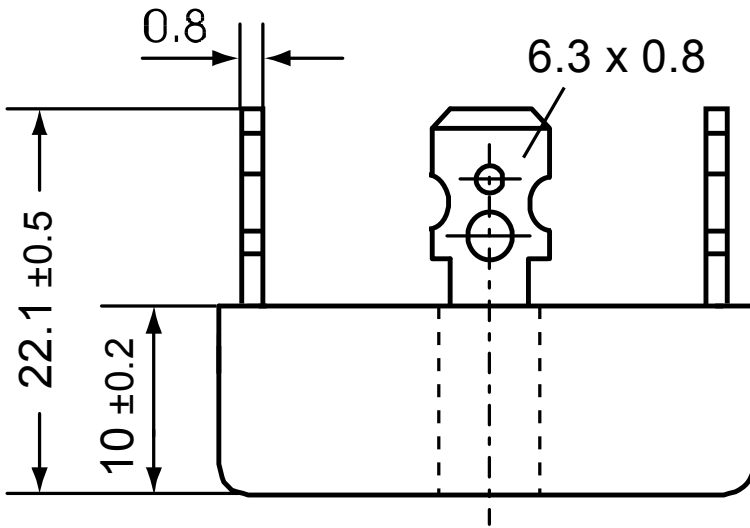

## Rectifier

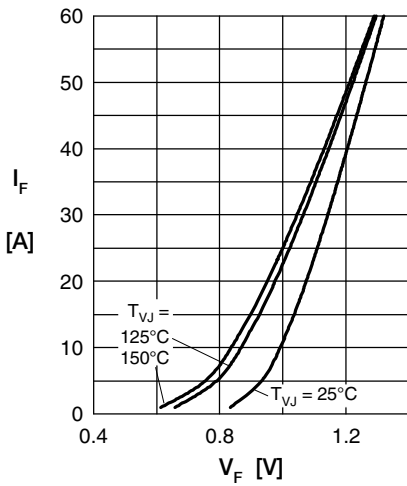

Fig. 1 Forward current vs. voltage drop per diode

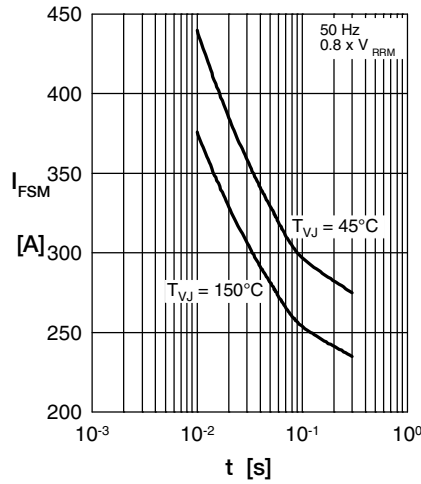

Fig. 2 Surge overload current vs. time per diode

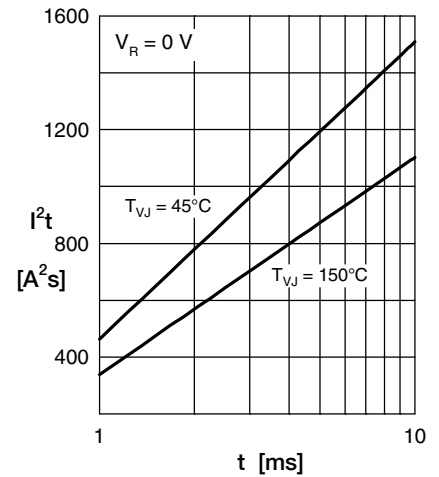

Fig. 3  $I^2t$  vs. time per diode

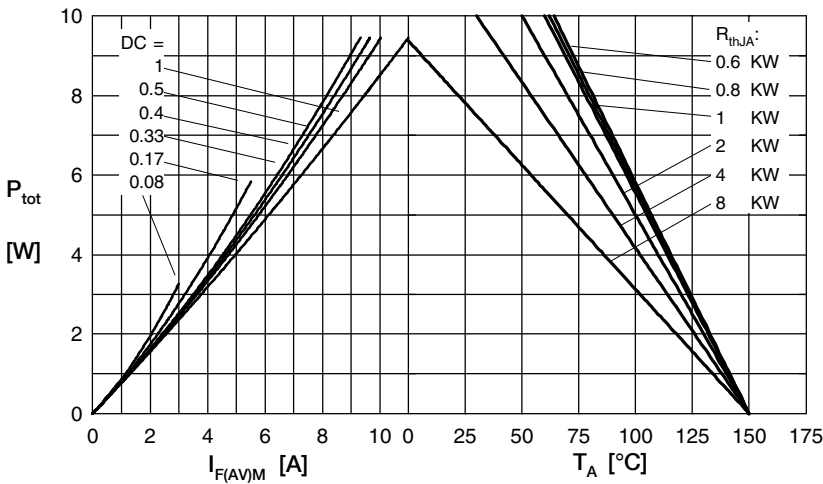

Fig. 4 Power dissipation vs. forward current and ambient temperature per diode

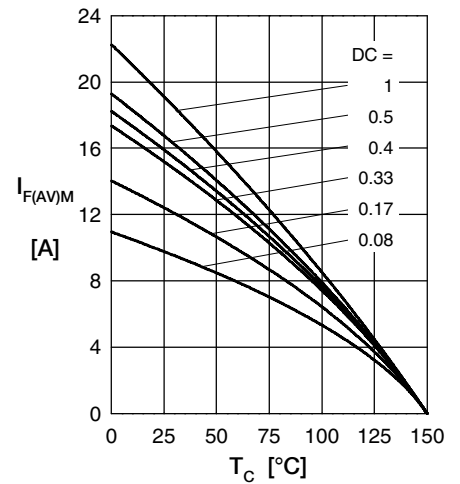

Fig. 5 Max. forward current vs. case temperature per diode

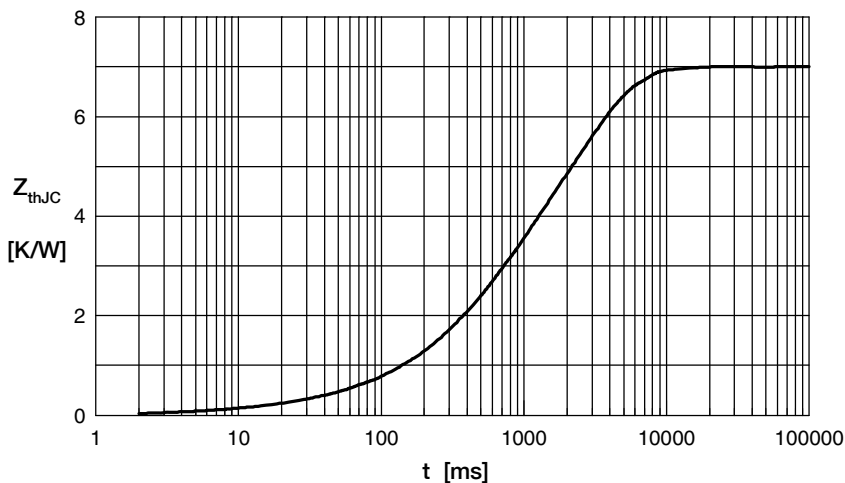

Fig. 6 Transient thermal impedance junction to case vs. time per diode

Constants for  $Z_{thJC}$  calculation:

i	$R_{th}$ (K/W)	$t_i$ (s)
1	0.040	0.005
2	0.150	0.030
3	1.710	0.400
4	5.100	2.300

# Mouser Electronics

Authorized Distributor

Click to View Pricing, Inventory, Delivery & Lifecycle Information:

[IXYS:](#)

[VUO36-16NO8](#)