

General Description

The MIC5319 is a high-performance, 500mA LDO regulator, offering extremely high PSRR and very-low noise while consuming low ground current.

Ideal for battery-operated applications, the MIC5319 features 1% accuracy, extremely low-dropout voltage (200mV @ 500mA), and low ground current at light load (typically 90 μ A). Equipped with a logic-compatible enable pin, the MIC5319 can be put into a zero-off-mode current state, drawing no current when disabled.

The MIC5319 is a μ Cap design operating with very-small ceramic output capacitors for stability, thereby reducing required board space and component cost.

The MIC5319 is available in fixed-output voltages and adjustable output voltages in the super-compact 2mm x 2mm MLF[®] leadless package and thin SOT-23-5 package.

Data sheets and support documentation can be found on Micrel's web site at www.micrel.com.

Features

- Ultra-low dropout voltage 200mV @ 500mA
- Input voltage range: 2.5 to 5.5V
- Stable with ceramic output capacitor
- Low output noise: 40 μ Vrms
- Low quiescent current of 90 μ A total
- High PSRR, up to 70dB @1kHz
- Fast turn-on-time: 40 μ s typical
- High-output accuracy:
 - \pm 1.0% initial accuracy
 - \pm 2.0% over temperature
- Thermal-shutdown protection
- Current-limit protection
- Logic-controlled Enable
- Tiny 2mm x 2mm MLF[®] package, 500mA continuous
- Thin SOT-23-5 package, 500mA peak

Applications

- Cellular phones
- PDAs
- Fiber optic modules
- Portable electronics
- Notebook PCs
- Audio Codec power supplies

Typical Application

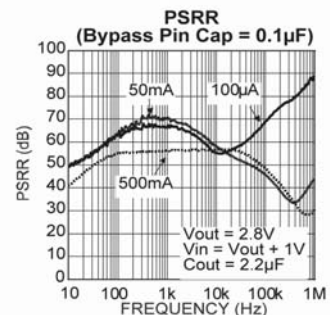
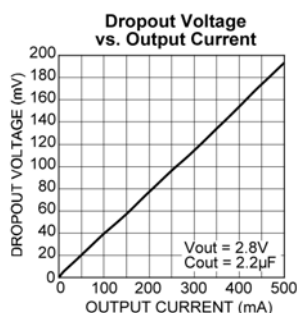
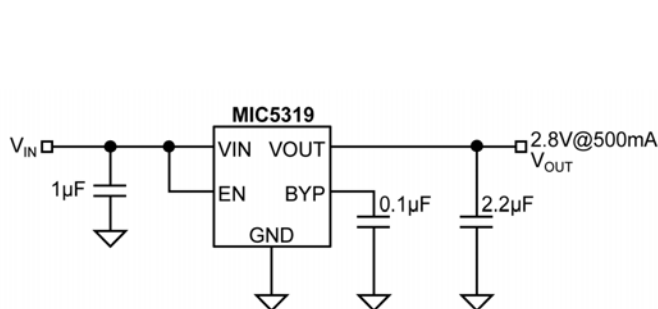

Ordering Information

Part Number	Marking ⁽¹⁾	Voltage ⁽²⁾ (V)	Junction Temperature Range	Package	Lead Finish
MIC5319-1.3HYML	<u>13</u> H	1.375	-40°C to +125°C	6-Pin 2mm × 2mm MLF [®]	Pb-Free
MIC5319-1.8YML	<u>918</u>	1.8	-40°C to +125°C	6-Pin 2mm × 2mm MLF [®]	Pb-Free
MIC5319-1.85YML	<u>91J</u>	1.85	-40°C to +125°C	6-Pin 2mm × 2mm MLF [®]	Pb-Free
MIC5319-2.5YML	<u>925</u>	2.5	-40°C to +125°C	6-Pin 2mm × 2mm MLF [®]	Pb-Free
MIC5319-2.6YML	<u>926</u>	2.6	-40°C to +125°C	6-Pin 2mm × 2mm MLF [®]	Pb-Free
MIC5319-2.7YML	<u>927</u>	2.7	-40°C to +125°C	6-Pin 2mm × 2mm MLF [®]	Pb-Free
MIC5319-2.8YML	<u>928</u>	2.8	-40°C to +125°C	6-Pin 2mm × 2mm MLF [®]	Pb-Free
MIC5319-2.85YML	<u>92J</u>	2.85	-40°C to +125°C	6-Pin 2mm × 2mm MLF [®]	Pb-Free
MIC5319-2.9YML	<u>929</u>	2.9	-40°C to +125°C	6-Pin 2mm × 2mm MLF [®]	Pb-Free
MIC5319-3.0YML	<u>930</u>	3.0	-40°C to +125°C	6-Pin 2mm × 2mm MLF [®]	Pb-Free
MIC5319-3.3YML	<u>933</u>	3.3	-40°C to +125°C	6-Pin 2mm × 2mm MLF [®]	Pb-Free
MIC5319-5.0YML	<u>950</u>	5.0	-40°C to +125°C	6-Pin 2mm × 2mm MLF [®]	Pb-Free
MIC5319YML	<u>9AA</u>	ADJ	-40°C to +125°C	6-Pin 2mm × 2mm MLF [®]	Pb-Free
MIC5319-1.3HYD5	<u>N13</u> H	1.375	-40°C to +125°C	Thin SOT-23-5	Pb-Free
MIC5319-1.8YD5	<u>N918</u>	1.8	-40°C to +125°C	Thin SOT-23-5	Pb-Free
MIC5319-1.85YD5	<u>N91J</u>	1.85	-40°C to +125°C	Thin SOT-23-5	Pb-Free
MIC5319-2.5YD5	<u>N925</u>	2.5	-40°C to +125°C	Thin SOT-23-5	Pb-Free
MIC5319-2.6YD5	<u>N926</u>	2.6	-40°C to +125°C	Thin SOT-23-5	Pb-Free
MIC5319-2.7YD5	<u>N927</u>	2.7	-40°C to +125°C	Thin SOT-23-5	Pb-Free
MIC5319-2.8YD5	<u>N928</u>	2.8	-40°C to +125°C	Thin SOT-23-5	Pb-Free
MIC5319-2.9YD5 ⁽³⁾	<u>N929</u>	2.9	-40°C to +125°C	Thin SOT-23-5	Pb-Free
MIC5319-3.0YD5	<u>N930</u>	3.0	-40°C to +125°C	Thin SOT-23-5	Pb-Free
MIC5319-3.3YD5	<u>N933</u>	3.3	-40°C to +125°C	Thin SOT-23-5	Pb-Free
MIC5319-5.0YD5	<u>N950</u>	5.0	-40°C to +125°C	Thin SOT-23-5	Pb-Free

Notes:

1. Under-bar/Over-bar symbols may not be to scale.
2. For other output voltage options, contact Micrel Marketing.
3. Contact Micrel Marketing for availability.

Pin Configuration

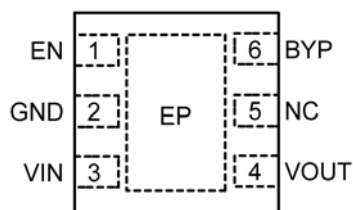

MIC5319 (Fixed)
6-Pin 2mm × 2mm MLF (ML)
 Top View

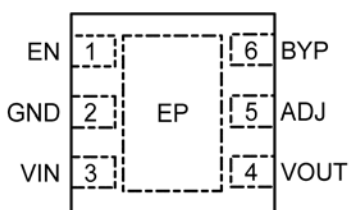

MIC5319 (Adjustable)
6-Pin 2mm × 2mm MLF (ML)
 Top View

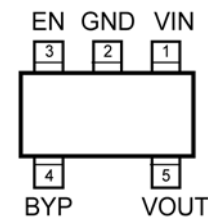

MIC5319 (Adjustable)
TSOT-23-5 (D5)
 Top View

Pin Description

Pin Number MLF-6 Fixed	Pin Number MLF-6 Adjustable	Pin Number TSOT-23-5 Fixed	Pin Name	Pin Name
1	1	3	EN	Enable Input: Active High. High = ON, Low = OFF. Do not leave floating.
2	2	2	GND	Ground.
3	3	1	VIN	Supply Input.
4	4	5	VOUT	Output Voltage.
–	5	–	ADJ	Adjustable Input: Connect to external resistor voltage divider network.
5	–	–	NC	No connection for fixed voltage parts
6	6	4	BYP	Reference Bypass: Connect external 0.1µF to GND for reduced output noise. May be left open.
EP	EP	–	ePad	Exposed Heatsink Pad connected to ground internally

Absolute Maximum Ratings⁽¹⁾

Supply Input Voltage (V_{IN})	0V to 6V
Enable Input Voltage (V_{EN})	0V to 6V
Power Dissipation (P_D)	Internally Limited ⁽³⁾
Junction Temperature (T_J)	-40°C to +125°C
Storage Temperature (T_S)	-65°C to +150°C
Lead Temperature (soldering, 5sec.)	260°C
ESD Rating ⁽⁴⁾	3kV

Operating Ratings⁽²⁾

Supply Input Voltage (V_{IN})	+2.5V to +5.5V
Enable Input Voltage (V_{EN})	0V to V_{IN}
Junction Temperature (T_J)	-40°C to +125°C
Package Thermal Resistance	
MLF (θ_{JA})	93°C/W
TSOT-23 (θ_{JA})	235°C/W

Electrical Characteristics⁽⁵⁾

$V_{IN} = V_{OUT} + 1.0V$; $C_{OUT} = 2.2\mu F$; $I_{OUT} = 100\mu A$; $T_J = 25^\circ C$, **bold** values indicate -40°C to +125°C, unless noted.

Parameter	Condition	Min.	Typ.	Max.	Units
Output Voltage Accuracy	Variation from nominal V_{OUT}	-1.0		+1.0	%
	Variation from nominal V_{OUT} , $I_{OUT} = 100mA$ to 500mA	-2.0		+2.0	
Feedback Voltage (ADJ Option)		1.2375	1.25	1.2625	V
		1.225	1.25	1.275	
Line Regulation	$V_{IN} = V_{OUT} + 1V$ to 5.5V		0.04	0.3	%/V
Load Regulation ⁽⁶⁾	$I_{OUT} = 100\mu A$ to 500mA		0.1	0.5	%
Dropout Voltage ^(7, 8)	$I_{OUT} = 50mA$		20	40	mV
	$I_{OUT} = 500mA$		200	400	
Ground Pin Current ⁽⁹⁾	$I_{OUT} = 0$ to 500mA		90	150	μA
Ground Pin Current in Shutdown	$V_{EN} \leq 0.2V$		0.5		μA
Ripple Rejection	$f =$ up to 1kHz; $C_{OUT} = 2.2\mu F$ ceramic; $C_{BYP} = 0.1 \mu F$		70		dB
	$f = 10kHz$; $C_{OUT} = 2.2\mu F$ ceramic; $C_{BYP} = 0.1 \mu F$		60		
Current Limit	$V_{OUT} = 0V$	600	700		mA
Output Voltage Noise	$C_{OUT} = 2.2\mu F$; $C_{BYP} = 0.1 \mu F$; 10Hz to 100kHz		40		μV_{rms}
Turn-On Time	$C_{OUT} = 2.2\mu F$; $C_{BYP} = 0.1 \mu F$		40	100	μs
Enable Input Voltage	Logic Low (Regulator Shutdown)			0.2	V
	Logic High (Regulator Enabled)	1.2			
Enable Input Current	$V_{IL} \leq 0.2V$ (Regulator Shutdown)		0.01	1	μA
	$V_{IH} \geq 1.0V$ (Regulator Shutdown)		0.01	1	

Notes:

- Exceeding the absolute maximum rating may damage the device.
- The device is not guaranteed to function outside its operating rating.
- The maximum allowable power dissipation of any T_A (ambient temperature) is $P_D(\max) = (T_{J(\max)} - T_A) / \theta_{JA}$. Exceeding the maximum allowable power dissipation will result in excessive die temperature, and the regulator may go into thermal shutdown.
- Devices are ESD sensitive. Handling precautions recommended. Human body model.
- Specification for packaged product only.
- Regulation is measured at constant junction temperature using low duty cycle pulse testing.
- Dropout voltage is defined as the input-to-output differential at which the output voltage drops 2% below its nominal V_{OUT} . For outputs below 2.5V, dropout voltage spec does not apply, as part is limited by minimum V_{IN} spec of 2.5V. There may be some typical dropout degradation at $V_{OUT} < 3V$.
- For ADJ option, $V_{OUT} = 3V$ for dropout specification.
- Ground pin current is the regulator quiescent current. The total current drawn from the supply is the sum of the load current plus the ground pin current.

Typical Characteristics

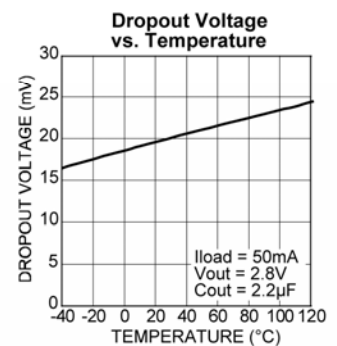
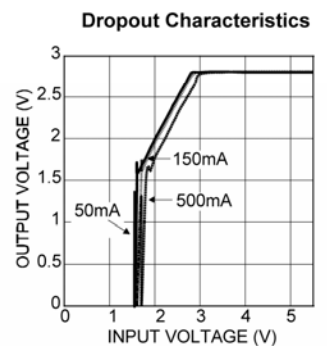
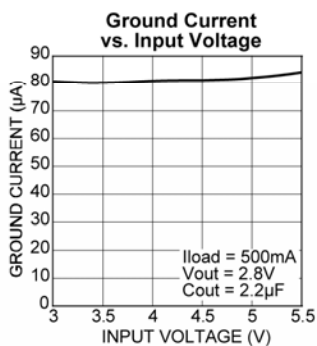
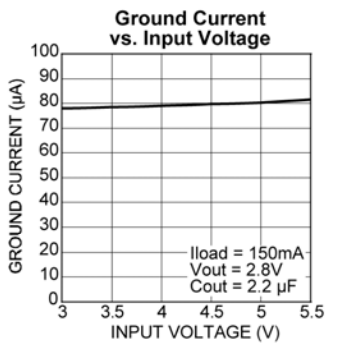
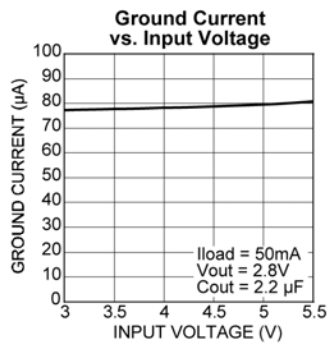
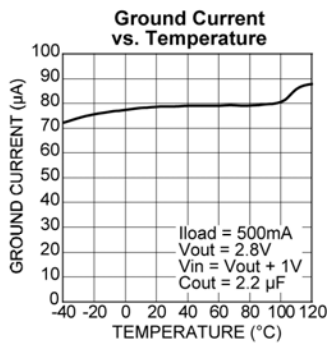
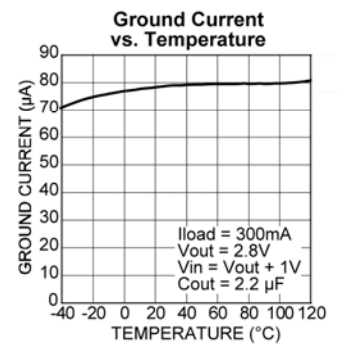
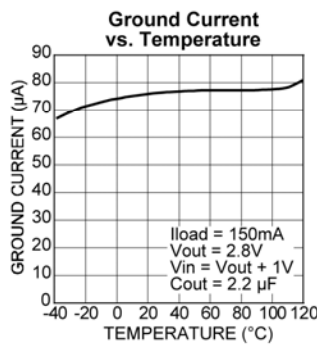
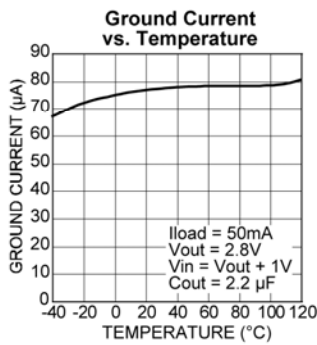
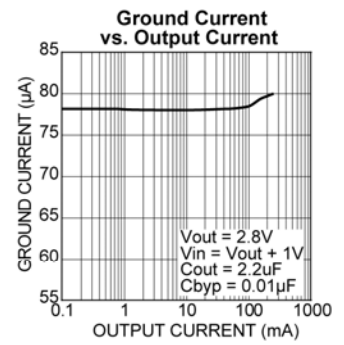
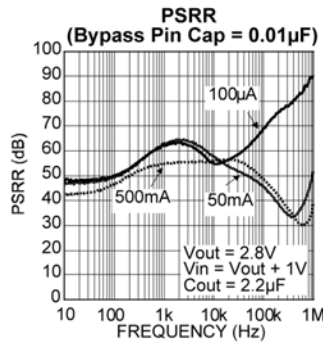
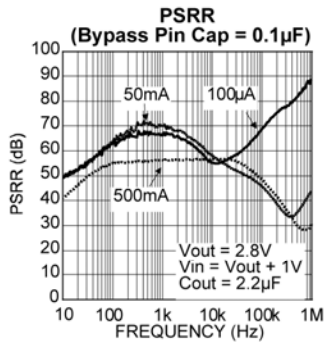

Typical Characteristics (Continued)

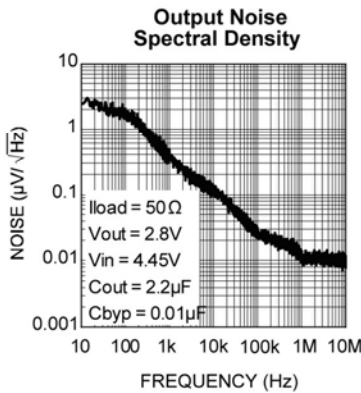
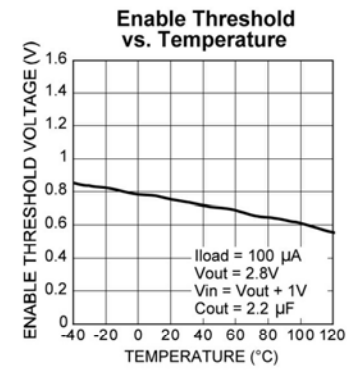
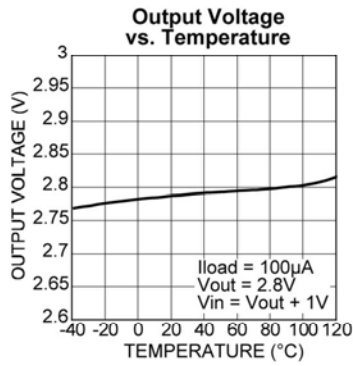
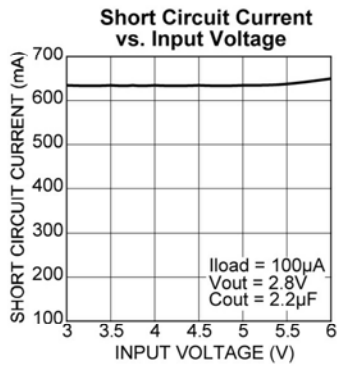
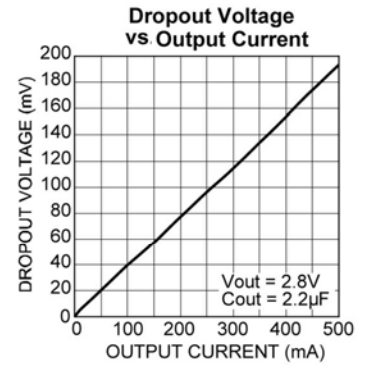
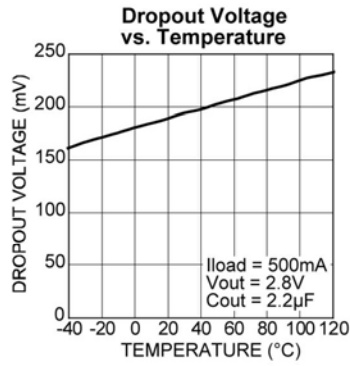
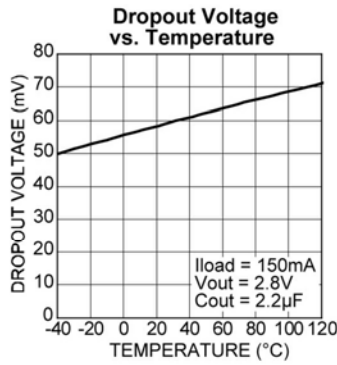

Functional Characteristics

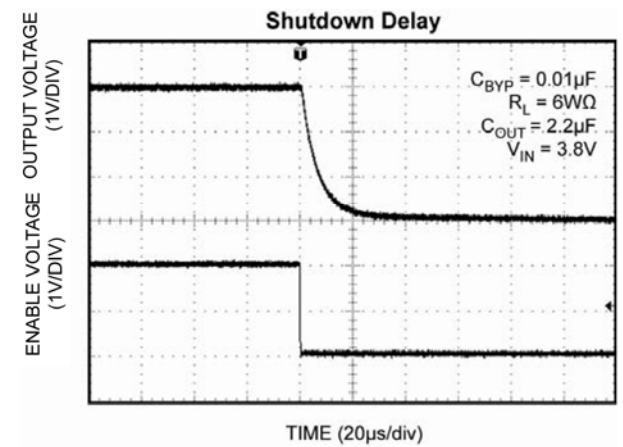
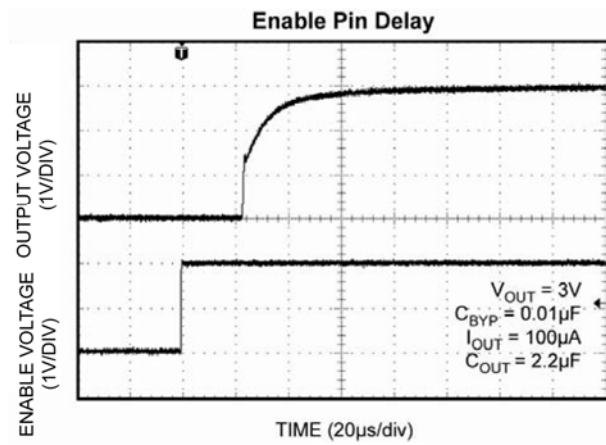
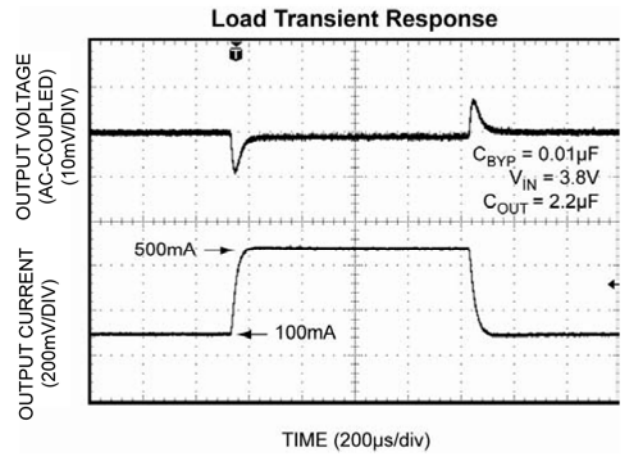
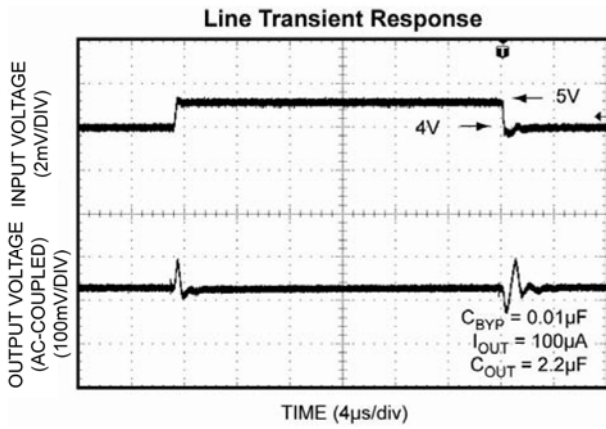

Functional Diagram

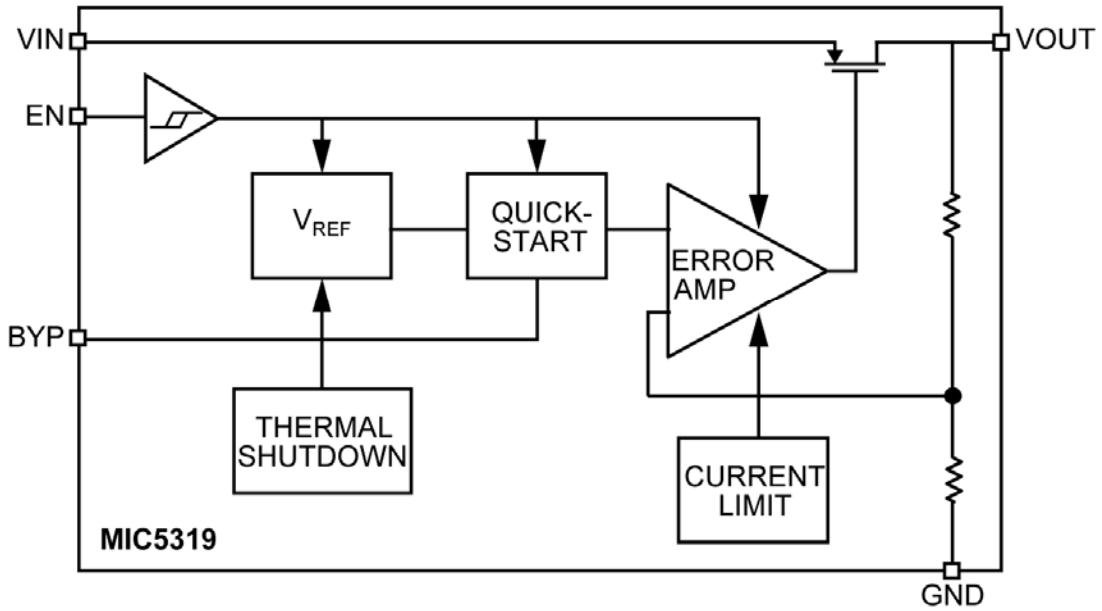

MIC5319 Block Diagram – Fixed

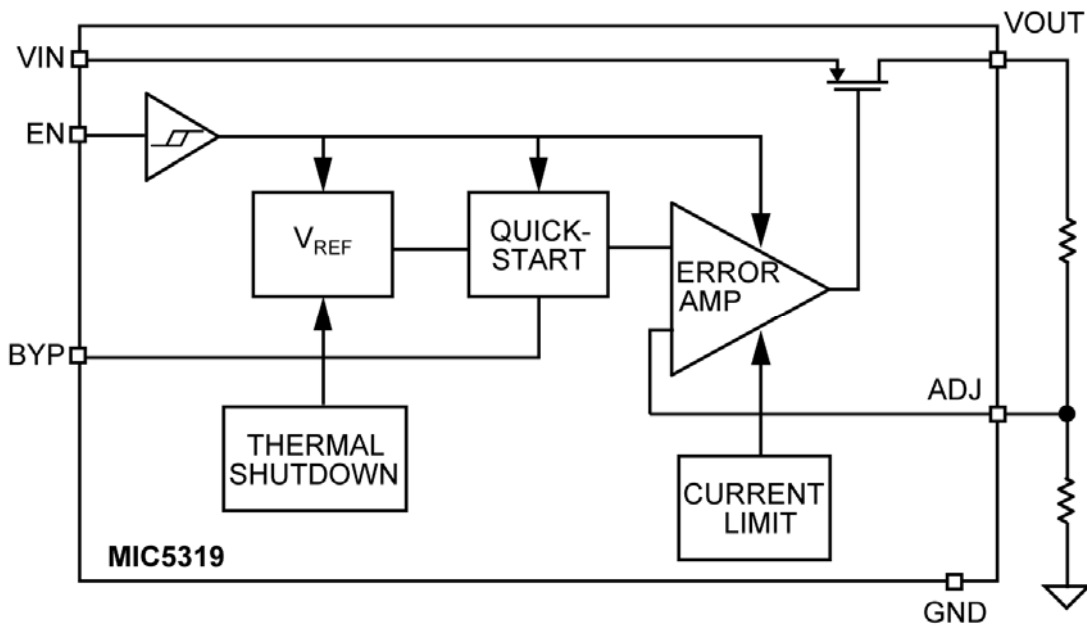

MIC5319 Block Diagram – Adjustable

Applications Information

Enable/Shutdown

The MIC5319 features an active-high enable pin that allows the regulator to be disabled. Forcing the enable pin low disables the regulator and sends it into a “zero” off-mode-current state. In this state, current consumed by the regulator goes nearly to zero. Forcing the enable pin high enables the output voltage. The active-high enable pin uses CMOS technology and the enable pin cannot be left floating, as this may cause an indeterminate state on the output.

Input Capacitor

The MIC5319 is a high-performance, high bandwidth device. Therefore, it requires a well-bypassed input supply for optimal performance. A 1 μ F capacitor is required from the input-to-ground to provide stability. Low-ESR ceramic capacitors provide optimal performance at a minimum of space. Additional high-frequency capacitors, such as small-valued NPO dielectric-type capacitors, help filter out high-frequency noise and are good design practice in any RF-based circuit.

Output Capacitor

The MIC5319 requires an output capacitor of 2.2 μ F or greater to maintain stability. The design is optimized for use with low-ESR ceramic chip capacitors. High ESR capacitors may cause high-frequency oscillation. The output capacitor can be increased, but performance has been optimized for a 2.2 μ F ceramic output capacitor and does not improve significantly with larger capacitance.

X7R/X5R dielectric-type ceramic capacitors are recommended because of their temperature performance. X7R-type capacitors change capacitance by 15% over their operating temperature range and are the most stable type of ceramic capacitors. Z5U and Y5V dielectric capacitors change value by as much as 50% and 60%, respectively, over their operating temperature ranges. To use a ceramic chip capacitor with Y5V dielectric, the value must be much higher than an X7R ceramic capacitor to ensure the same minimum capacitance over the equivalent operating temperature range.

Bypass Capacitor

A capacitor can be placed from the bypass pin-to-ground to reduce output voltage noise. The capacitor bypasses the internal reference. A 0.1 μ F capacitor is recommended for applications that require low-noise outputs. The bypass capacitor can be increased, further reducing noise and improving PSRR. Turn-on time increases slightly with respect to bypass capacitance.

A unique, quick-start circuit allows the MIC5319 to drive a large capacitor on the bypass pin without significantly slowing turn-on time. Refer to the “Typical Characteristics” section for performance with different bypass capacitors.

No-Load Stability

Unlike many other voltage regulators, the MIC5319 will remain stable and in regulation with no load. This is especially important in CMOS RAM keep-alive applications.

Adjustable Regulator Application

Adjustable regulators use the ratio of two resistors to multiply the reference voltage to produce the desired output voltage.

The MIC5319 can be adjusted from 1.25V to 5.5V by using two external resistors (Figure 1). The resistors set the output voltage based on the following equation:

$$V_{OUT} = V_{REF} \left(1 + \frac{R1}{R2} \right)$$

$$V_{REF} = 1.25V$$

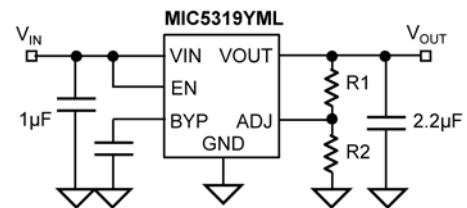

Figure 1. Adjustable Voltage Application

Thermal Considerations

The MIC5319 is designed to provide 500mA of continuous current in a very small MLF package. Maximum ambient operating temperature can be calculated based on the output current and the voltage drop across the part. Given an input voltage of 3.3V, output voltage of 2.8V and output current = 500mA, the actual power dissipation of the regulator circuit can be determined using the equation:

$$P_D = (V_{IN} - V_{OUT})I_{OUT} + V_{IN} \times I_{GND}$$

Because this device is CMOS and the ground current is typically $<100\mu\text{A}$ over the load range, the power dissipation contributed by the ground current is $<1\%$ and can be ignored for this calculation:

$$P_D = (3.3\text{V} - 2.8\text{V}) \times 500\text{mA}$$

$$P_D = 0.25\text{W}$$

To determine the maximum ambient operating temperature of the package, use the junction-to-ambient thermal resistance of the device and the following basic equation:

$$P_D(\text{max}) = \left(\frac{T_J(\text{max}) - T_A}{\theta_{JA}} \right)$$

$T_J(\text{max}) = 125^\circ\text{C}$, the maximum junction temperature of the die. θ_{JA} thermal resistance = 93°C/W .

Table 1 shows junction-to-ambient thermal resistance for the MIC5319 in the $2\text{mm} \times 2\text{mm}$ MLF[®] package.

Package	θ_{JA} Recommended Minimum Footprint	θ_{JC}
$2\text{mm} \times 2\text{mm}$ MLF [®]	93°C/W	45°C/W
Thin SOT-23-5	235°C/W	

Table 1. Thermal Resistance

Substituting 0.25W for $P_D(\text{max})$ and solving for the ambient operating temperature will give the maximum operating conditions for the regulator circuit. The maximum power dissipation must not be exceeded for proper operation.

$$0.25\text{W} = \frac{125^\circ\text{C} - T_A}{93^\circ\text{C/W}}$$

$$T_A = 101.75^\circ\text{C}$$

Therefore, a 2.8V application at 500mA of output current can accept an ambient operating temperature of 101.75°C in a $2\text{mm} \times 2\text{mm}$ MLF[®] package. For a full discussion of heat sinking and thermal effects on voltage regulators, refer to the "Regulator Thermals" section of Micrel's Designing with Low-Dropout Voltage Regulators handbook. This information can be found on Micrel's website at: www.micrel.com/PDF/other/LDOBk_ds.pdf

Package Information

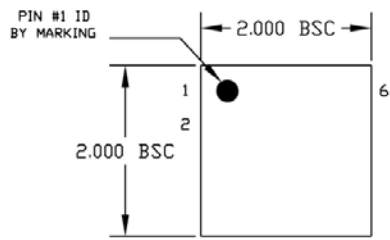

TOP VIEW

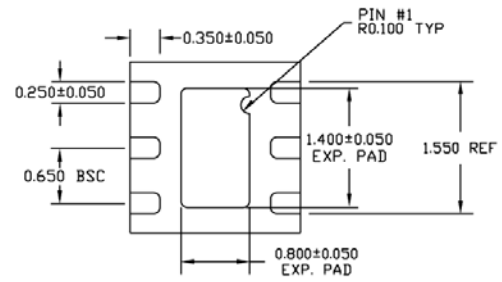

BOTTOM VIEW

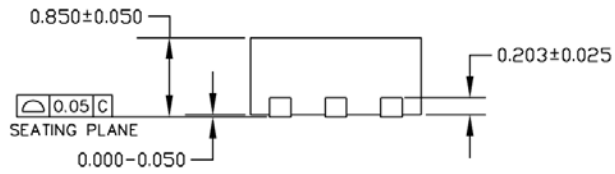

SIDE VIEW

NOTE:

1. ALL DIMENSIONS ARE IN MILLIMETERS.
2. MAX. PACKAGE WARPAGE IS 0.05 mm.
3. MAXIMUM ALLOWABLE BURRS IS 0.076 mm IN ALL DIRECTIONS.
4. PIN #1 ID ON TOP WILL BE LASER MARKED.

6-Pin 2mm × 2mm MLF[®] (ML)

Package Information (Continued)

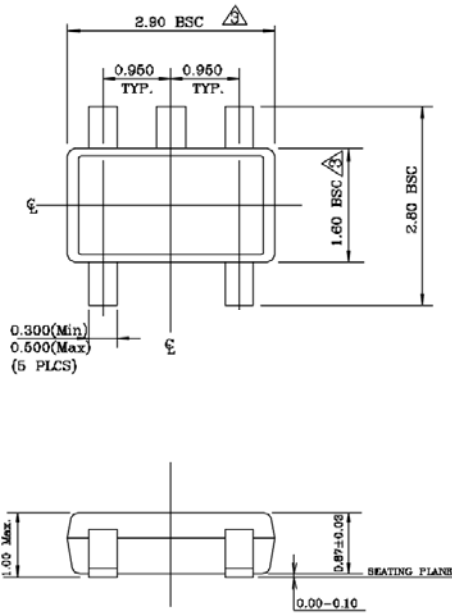

NOTE:

1. Dimensions and tolerances are as per ANSI Y14.5M, 1994.
2. Die is facing up for mold. Die is facing down for trim/form, ie. reverse trim/form.
3. Dimensions are exclusive of mold flash and gate burr.
4. The footlength measuring is based on the gauge plane method.
5. All specification comply to Jedec Spec MO193 Issue C.
6. All dimensions are in millimeters.

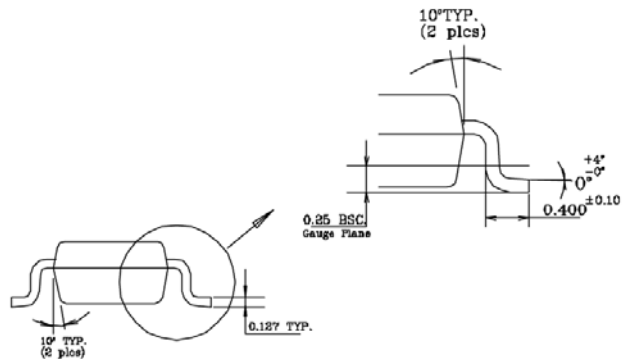

TSOT-23-5 (D5)

MICREL, INC. 2180 FORTUNE DRIVE SAN JOSE, CA 95131 USA

TEL +1 (408) 944-0800 FAX +1 (408) 474-1000 WEB <http://www.micrel.com>

Micrel makes no representations or warranties with respect to the accuracy or completeness of the information furnished in this data sheet. This information is not intended as a warranty and Micrel does not assume responsibility for its use. Micrel reserves the right to change circuitry, specifications and descriptions at any time without notice. No license, whether express, implied, arising by estoppel or otherwise, to any intellectual property rights is granted by this document. Except as provided in Micrel's terms and conditions of sale for such products, Micrel assumes no liability whatsoever, and Micrel disclaims any express or implied warranty relating to the sale and/or use of Micrel products including liability or warranties relating to fitness for a particular purpose, merchantability, or infringement of any patent, copyright or other intellectual property right.

Micrel Products are not designed or authorized for use as components in life support appliances, devices or systems where malfunction of a product can reasonably be expected to result in personal injury. Life support devices or systems are devices or systems that (a) are intended for surgical implant into the body or (b) support or sustain life, and whose failure to perform can be reasonably expected to result in a significant injury to the user. A Purchaser's use or sale of Micrel Products for use in life support appliances, devices or systems is a Purchaser's own risk and Purchaser agrees to fully indemnify Micrel for any damages resulting from such use or sale.

© 2010 Micrel, Incorporated.

Mouser Electronics

Authorized Distributor

Click to View Pricing, Inventory, Delivery & Lifecycle Information:

Micrel:

[MIC5319-3.3YML TR](#) [MIC5319-2.7YD5 TR](#) [MIC5319-3.3YD5 TR](#) [MIC5319-2.8YML TR](#) [MIC5319-2.5YML TR](#)
[MIC5319-1.3HYML TR](#) [MIC5319-3.0YD5 TR](#) [MIC5319-2.5YD5 TR](#) [MIC5319-2.6YML TR](#) [MIC5319-1.85YD5 TR](#)
[MIC5319-2.8YD5 TR](#) [MIC5319-1.8YD5 TR](#) [MIC5319-1.3HYD5 TR](#) [MIC5319-2.85YML TR](#) [MIC5319YML-TR](#)
[MIC5319-1.3HYD5-TR](#) [MIC5319-1.8YML-TR](#) [MIC5319-3.0YML-TR](#) [MIC5319-2.6YML-TR](#) [MIC5319-3.3YD5-TR](#)
[MIC5319-2.8YD5-TR](#) [MIC5319-5.0YD5-TR](#) [MIC5319-2.5YML-TR](#) [MIC5319-2.85YML-TR](#) [MIC5319-2.5YD5-TR](#)
[MIC5319-1.8YD5-TR](#) [MIC5319-2.7YML-TR](#) [MIC5319-1.3HYML-TR](#) [MIC5319-1.85YD5-TR](#) [MIC5319-5.0YML-TR](#)
[MIC5319-2.6YD5-TR](#) [MIC5319-3.3YML-TR](#) [MIC5319-2.8YML-TR](#) [MIC5319-2.7YD5-TR](#) [MIC5319-2.9YML-TR](#)
[MIC5319-1.85YML-TR](#) [MIC5319-3.0YD5-TR](#)