

RF Power Field Effect Transistor

N-Channel Enhancement-Mode Lateral MOSFET

Designed primarily for wideband applications with frequencies up to 500 MHz. Device is unmatched and is suitable for use in broadcast applications.

- Typical DVB-T OFDM Performance: $V_{DD} = 50$ Volts, $I_{DQ} = 2600$ mA, $P_{out} = 125$ Watts Avg., $f = 225$ MHz, Channel Bandwidth = 7.61 MHz, Input Signal PAR = 9.3 dB @ 0.01% Probability on CCDF.
Power Gain — 25 dB
Drain Efficiency — 28.5%
ACPR @ 4 MHz Offset — -61 dBc @ 4 kHz Bandwidth
- Typical Pulsed Performance: $V_{DD} = 50$ Volts, $I_{DQ} = 2600$ mA, $P_{out} = 600$ Watts Peak, $f = 225$ MHz, Pulse Width = 100 μ sec, Duty Cycle = 20%
Power Gain — 25.3 dB
Drain Efficiency — 59%
- Capable of Handling 10:1 VSWR, @ 50 Vdc, 225 MHz, 600 Watts Peak Power, Pulse Width = 100 μ sec, Duty Cycle = 20%

Features

- Characterized with Series Equivalent Large-Signal Impedance Parameters
- CW Operation Capability with Adequate Cooling
- Qualified Up to a Maximum of 50 V_{DD} Operation
- Integrated ESD Protection
- Designed for Push-Pull Operation
- Greater Negative Gate-Source Voltage Range for Improved Class C Operation
- RoHS Compliant
- In Tape and Reel. R6 Suffix = 150 Units per 56 mm, 13 inch Reel.

MRF6VP2600HR6

**2-500 MHz, 600 W, 50 V
LATERAL N-CHANNEL
BROADBAND
RF POWER MOSFET**

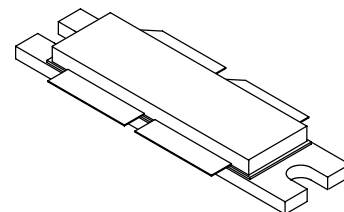

**CASE 375D-05, STYLE 1
NI-1230**

PART IS PUSH-PULL

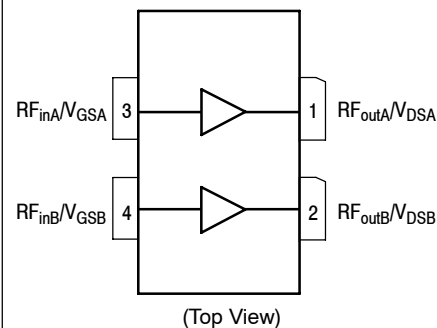

Figure 1. Pin Connections

Table 1. Maximum Ratings

Rating	Symbol	Value	Unit
Drain-Source Voltage	V_{DSS}	-0.5, +110	Vdc
Gate-Source Voltage	V_{GS}	-6.0, +10	Vdc
Storage Temperature Range	T_{stg}	- 65 to +150	$^{\circ}$ C
Case Operating Temperature	T_C	150	$^{\circ}$ C
Operating Junction Temperature (1,2)	T_J	225	$^{\circ}$ C

Table 2. Thermal Characteristics

Characteristic	Symbol	Value (2,3)	Unit
Thermal Resistance, Junction to Case	$R_{\theta JC}$		$^{\circ}$ C/W
Case Temperature 99 $^{\circ}$ C, 125 W CW, 225 MHz, 50 Vdc, $I_{DQ} = 2600$ mA		0.20	
Case Temperature 64 $^{\circ}$ C, 610 W CW, 352.2 MHz, 50 Vdc, $I_{DQ} = 150$ mA		0.14	
Case Temperature 81 $^{\circ}$ C, 610 W CW, 88-108 MHz, 50 Vdc, $I_{DQ} = 150$ mA		0.16	

1. Continuous use at maximum temperature will affect MTTF.
2. MTTF calculator available at <http://www.freescale.com/rf>. Select Software & Tools/Development Tools/Calculators to access MTTF calculators by product.
3. Refer to AN1955, *Thermal Measurement Methodology of RF Power Amplifiers*. Go to <http://www.freescale.com/rf>. Select Documentation/Application Notes - AN1955.

Table 3. ESD Protection Characteristics

Test Methodology	Class
Human Body Model (per JESD22-A114)	2 (Minimum)
Machine Model (per EIA/JESD22-A115)	A (Minimum)
Charge Device Model (per JESD22-C101)	IV (Minimum)

Table 4. Electrical Characteristics ($T_A = 25^\circ\text{C}$ unless otherwise noted)

Characteristic	Symbol	Min	Typ	Max	Unit
----------------	--------	-----	-----	-----	------

Off Characteristics ⁽¹⁾

Gate-Source Leakage Current ($V_{GS} = 5\text{ Vdc}$, $V_{DS} = 0\text{ Vdc}$)	I_{GSS}	—	—	10	μAdc
Drain-Source Breakdown Voltage ($I_D = 150\text{ mA}$, $V_{GS} = 0\text{ Vdc}$)	$V_{(BR)DSS}$	110	—	—	Vdc
Zero Gate Voltage Drain Leakage Current ($V_{DS} = 50\text{ Vdc}$, $V_{GS} = 0\text{ Vdc}$)	I_{DSS}	—	—	50	μAdc
Zero Gate Voltage Drain Leakage Current ($V_{DS} = 100\text{ Vdc}$, $V_{GS} = 0\text{ Vdc}$)	I_{DSS}	—	—	2.5	mA

On Characteristics

Gate Threshold Voltage ⁽¹⁾ ($V_{DS} = 10\text{ Vdc}$, $I_D = 800\ \mu\text{Adc}$)	$V_{GS(th)}$	1	1.65	3	Vdc
Gate Quiescent Voltage ⁽²⁾ ($V_{DD} = 50\text{ Vdc}$, $I_D = 2600\text{ mA}$, Measured in Functional Test)	$V_{GS(Q)}$	1.5	2.7	3.5	Vdc
Drain-Source On-Voltage ⁽¹⁾ ($V_{GS} = 10\text{ Vdc}$, $I_D = 2\text{ Adc}$)	$V_{DS(on)}$	—	0.25	—	Vdc

Dynamic Characteristics ⁽¹⁾

Reverse Transfer Capacitance ($V_{DS} = 50\text{ Vdc} \pm 30\text{ mV(rms)ac}$ @ 1 MHz, $V_{GS} = 0\text{ Vdc}$)	C_{rss}	—	1.7	—	pF
Output Capacitance ($V_{DS} = 50\text{ Vdc} \pm 30\text{ mV(rms)ac}$ @ 1 MHz, $V_{GS} = 0\text{ Vdc}$)	C_{oss}	—	101	—	pF
Input Capacitance ($V_{DS} = 50\text{ Vdc}$, $V_{GS} = 0\text{ Vdc} \pm 30\text{ mV(rms)ac}$ @ 1 MHz)	C_{iss}	—	287	—	pF

Functional Tests ⁽²⁾ (In Freescale Test Fixture, 50 ohm system) $V_{DD} = 50\text{ Vdc}$, $I_{DQ} = 2600\text{ mA}$, $P_{out} = 125\text{ W Avg.}$, $f = 225\text{ MHz}$, DVB-T OFDM Single Channel. ACPR measured in 7.61 MHz Channel Bandwidth @ $\pm 4\text{ MHz}$ Offset.

Power Gain	G_{ps}	24	25	27	dB
Drain Efficiency	η_D	27	28.5	—	%
Adjacent Channel Power Ratio	ACPR	—	-61	-59	dBc
Input Return Loss	IRL	—	-18	-9	dB

Typical Performance — 352.2 MHz (In Freescale 352.2 MHz Test Fixture, 50 ohm system) $V_{DD} = 50\text{ Vdc}$, $I_{DQ} = 150\text{ mA}$, $P_{out} = 600\text{ W CW}$

Power Gain	G_{ps}	—	22	—	dB
Drain Efficiency	η_D	—	68	—	%
Input Return Loss	IRL	—	-15	—	dB

Typical Performance — 88-108 MHz (In Freescale 88-108 MHz Test Fixture, 50 ohm system) $V_{DD} = 50\text{ Vdc}$, $I_{DQ} = 150\text{ mA}$, $P_{out} = 600\text{ W CW}$

Power Gain	G_{ps}	—	24.5	—	dB
Drain Efficiency	η_D	—	74	—	%
Input Return Loss	IRL	—	-5	—	dB

- Each side of device measured separately.
- Measurement made with device in push-pull configuration.

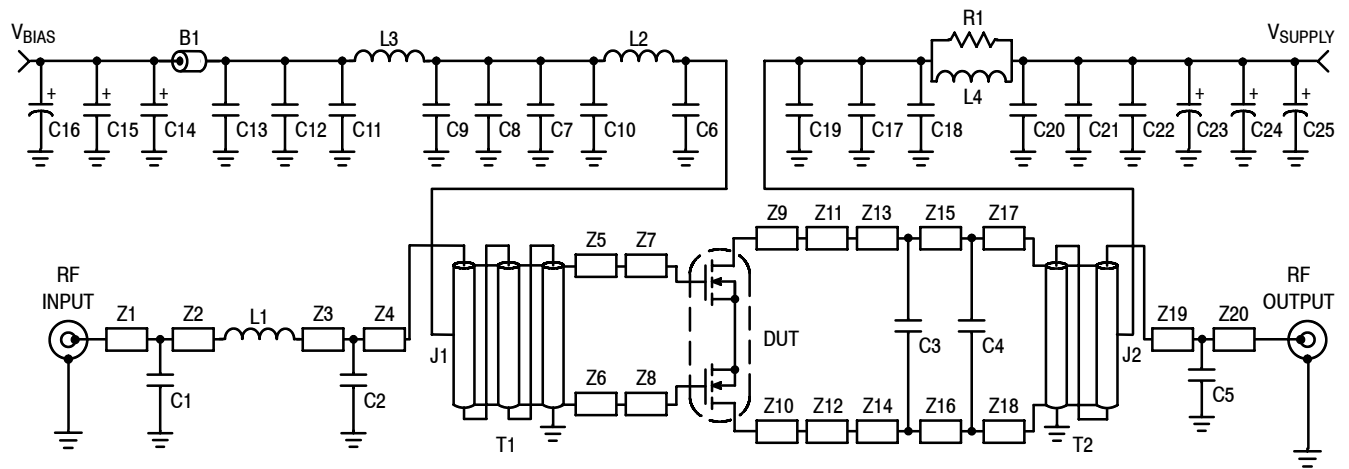

Z1	1.049" x 0.080" Microstrip	Z13, Z14	0.224" x 0.253" Microstrip
Z2*	0.143" x 0.080" Microstrip	Z15*, Z16*	0.095" x 0.253" Microstrip
Z3*	0.188" x 0.080" Microstrip	Z17, Z18	0.052" x 0.253" Microstrip
Z4	0.192" x 0.133" Microstrip	Z19	0.053" x 0.080" Microstrip
Z5, Z6	0.418" x 0.193" Microstrip	Z20	1.062" x 0.080" Microstrip
Z7, Z8	0.217" x 0.518" Microstrip	PCB	Arlon CuClad 250GX-0300-55-22, 0.030", $\epsilon_r = 2.55$
Z9, Z10	0.200" x 0.518" Microstrip		
Z11, Z12	0.375" x 0.214" Microstrip		
			* Line length includes microstrip bends

Figure 2. MRF6VP2600HR6 Test Circuit Schematic

Table 5. MRF6VP2600HR6 Test Circuit Component Designations and Values

Part	Description	Part Number	Manufacturer
B1	95 Ω , 100 MHz Long Ferrite Bead	2743021447	Fair-Rite
C1	47 pF Chip Capacitor	ATC100B470JT500XT	ATC
C2, C4	43 pF Chip Capacitors	ATC100B430JT500XT	ATC
C3	100 pF Chip Capacitor	ATC100B101JT500XT	ATC
C5	10 pF Chip Capacitor	ATC100B7R5CT500XT	ATC
C6, C9	2.2 μ F, 50 V Chip Capacitors	C1825C225J5RAC	Kemet
C7, C13, C20	10K pF Chip Capacitors	ATC200B103KT50XT	ATC
C8	220 nF, 50 V Chip Capacitor	C1812C224J5RAC	Kemet
C10, C17, C18	1000 pF Chip Capacitors	ATC100B102JT50XT	ATC
C11, C22	0.1 μ F, 50 V Chip Capacitors	CDR33BX104AKYS	Kemet
C12, C21	20K pF Chip Capacitors	ATC200B203KT50XT	ATC
C14	10 μ F, 35 V Tantalum Capacitor	T491D106K035AT	Kemet
C15	22 μ F, 35 V Tantalum Capacitor	T491X226K035AT	Kemet
C16	47 μ F, 50 V Electrolytic Capacitor	476KXM050M	Illinois Cap
C19	2.2 μ F, Chip Capacitor	2225X7R225KT3AB	ATC
C23, C24, C25	470 μ F 63V Electrolytic Capacitors	MCGPR63V477M13X26-RH	Multicomp
J1, J2	Jumpers from PCB to T1 & T2	Copper Foil	
L1	17.5 nH, 6 Turn Inductor	B06T	CoilCraft
L2	8 Turn, #20 AWG ID = 0.125" Inductor, Hand Wound	Copper Wire	
L3	82 nH, Inductor	1812SMS-82NJ	CoilCraft
L4*	9 Turn, #18 AWG Inductor, Hand Wound	Copper Wire	
R1	20 Ω , 3 W Axial Leaded Resistor	5093NW20R00J	Vishay
T1	Balun	TUI-9	Comm Concepts
T2	Balun	TUO-4	Comm Concepts

*L4 is wrapped around R1.

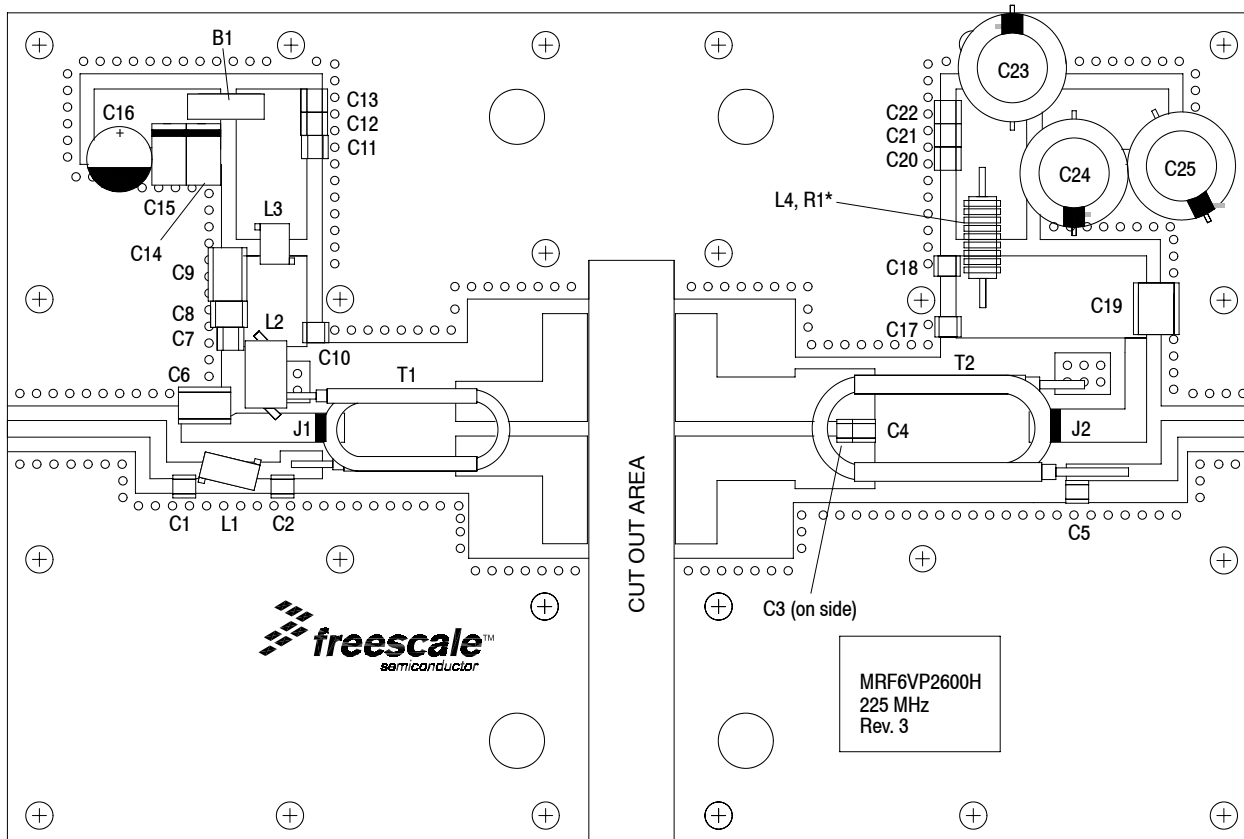

* L4 is wrapped around R1.

Figure 3. MRF6VP2600HR6 Test Circuit Component Layout

TYPICAL CHARACTERISTICS

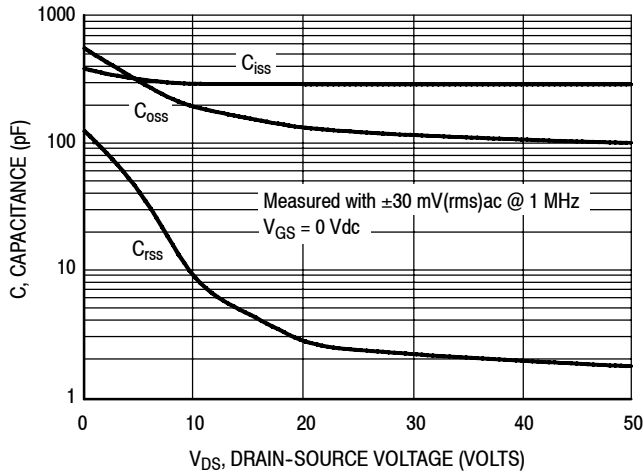

Note: Each side of device measured separately.

Figure 4. Capacitance versus Drain-Source Voltage

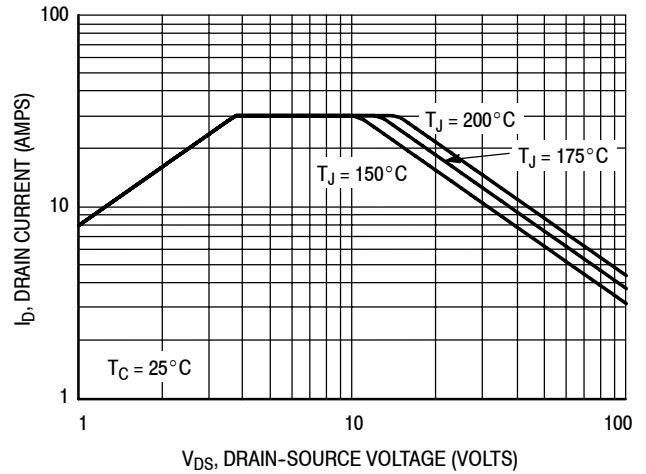

Note: Each side of device measured separately.

Figure 5. DC Safe Operating Area

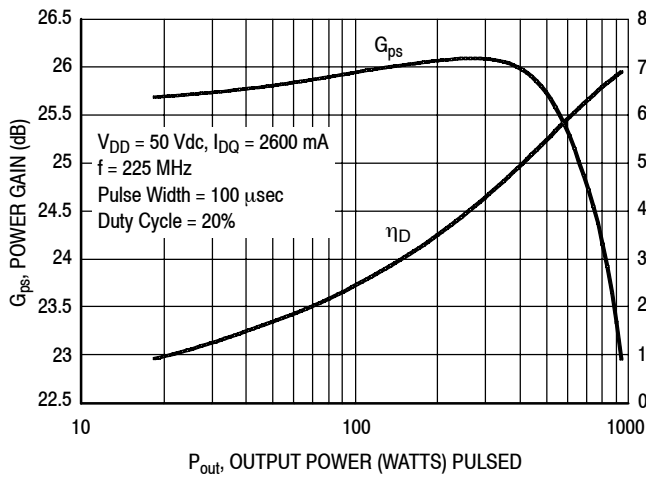

Figure 6. Pulsed Power Gain and Drain Efficiency versus Output Power

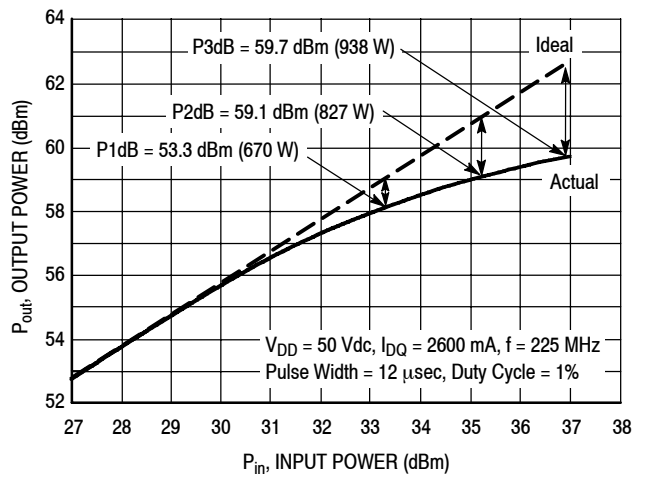

Figure 7. Pulsed CW Output Power versus Input Power

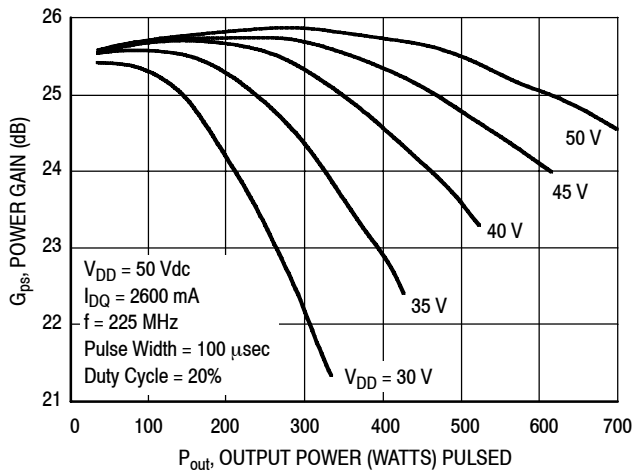

Figure 8. Pulsed Power Gain versus Output Power

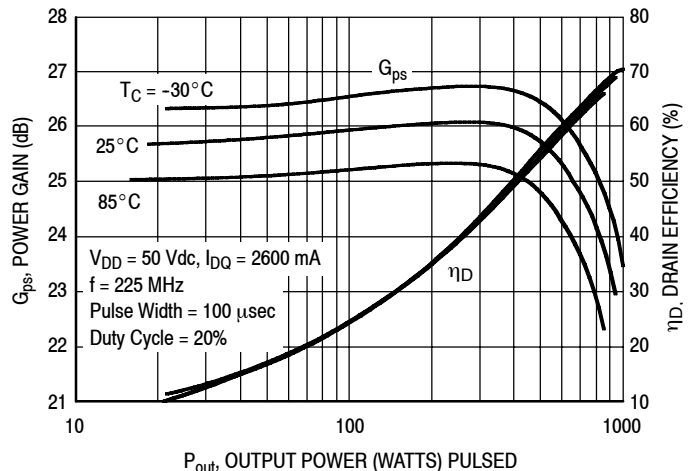

Figure 9. Pulsed Power Gain and Drain Efficiency versus Output Power

TYPICAL CHARACTERISTICS — TWO-TONE

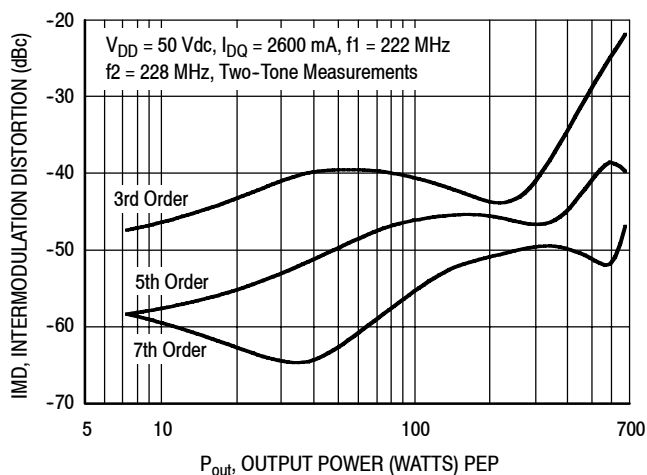

Figure 10. Intermodulation Distortion Products versus Output Power

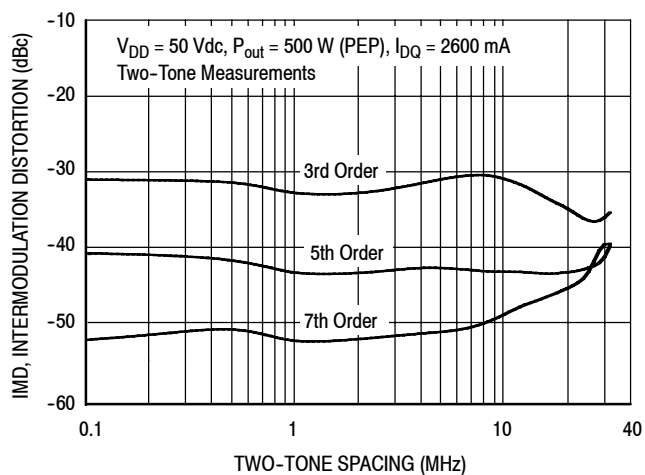

Figure 11. Intermodulation Distortion Products versus Tone Spacing

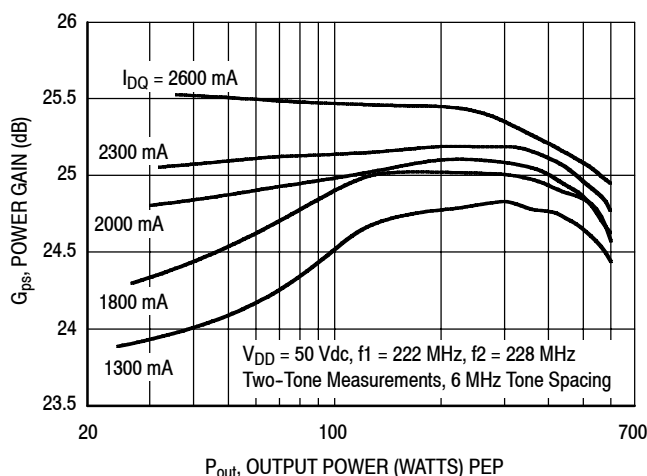

Figure 12. Two-Tone Power Gain versus Output Power

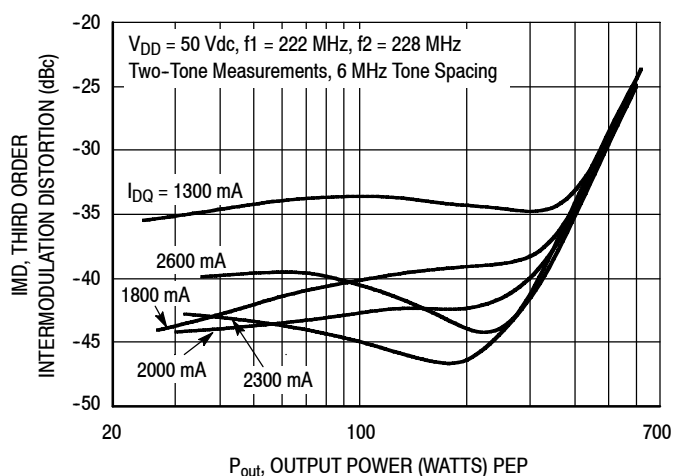

Figure 13. Third Order Intermodulation Distortion versus Output Power

TYPICAL CHARACTERISTICS — OFDM

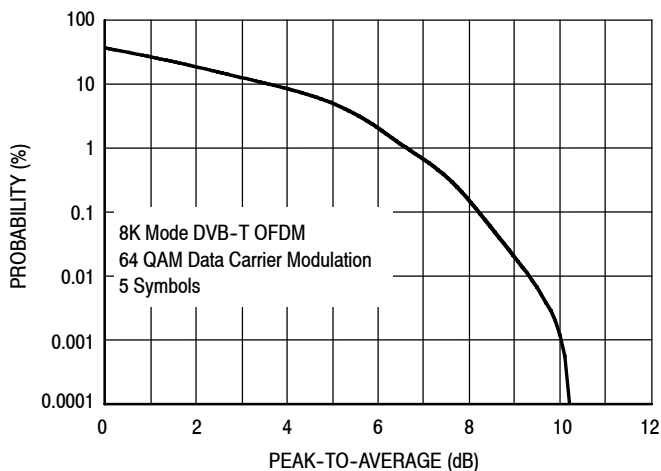

Figure 14. Single-Carrier DVB-T OFDM

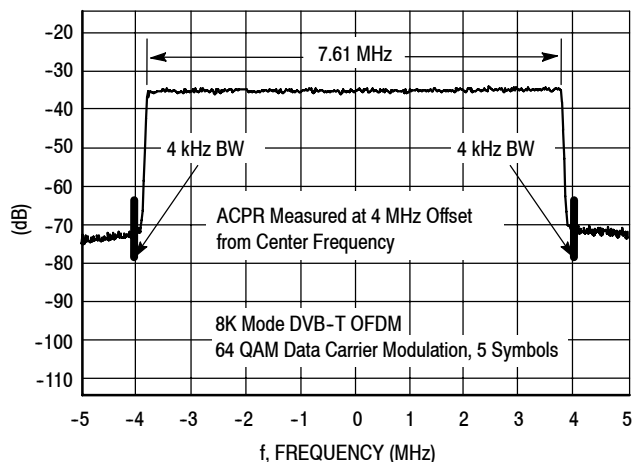

Figure 15. 8K Mode DVB-T OFDM Spectrum

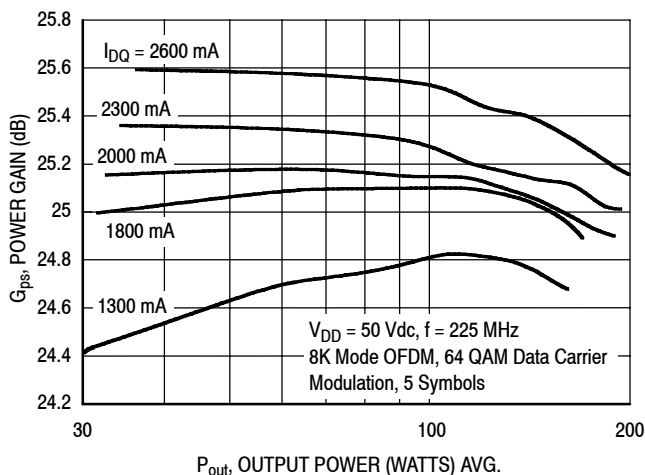

Figure 16. Single-Carrier DVB-T OFDM Power Gain versus Output Power

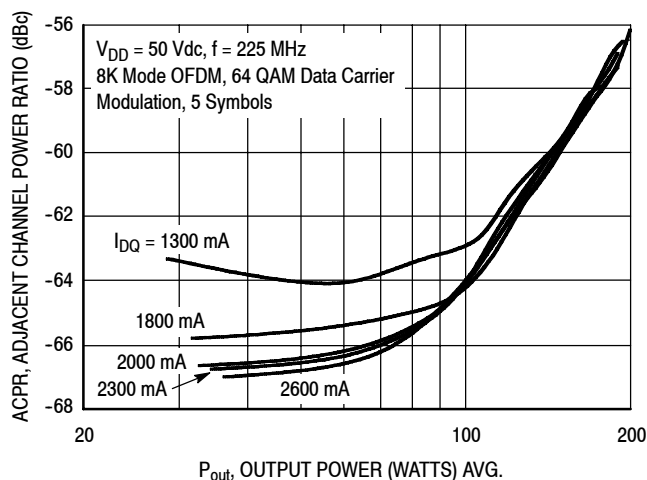

Figure 17. Single-Carrier DVB-T OFDM ACPR versus Output Power

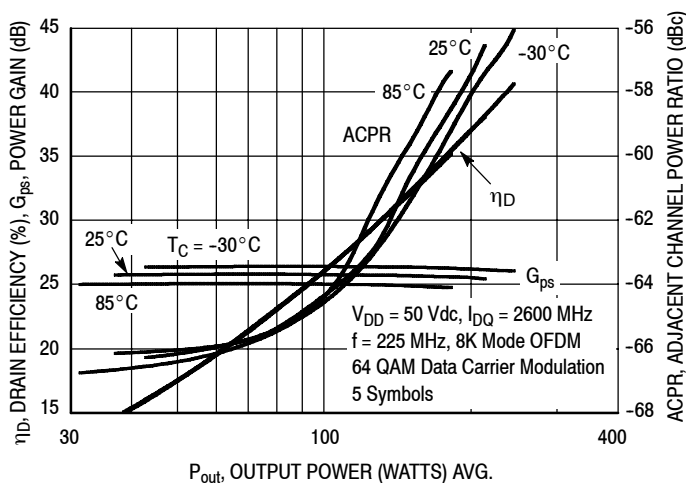
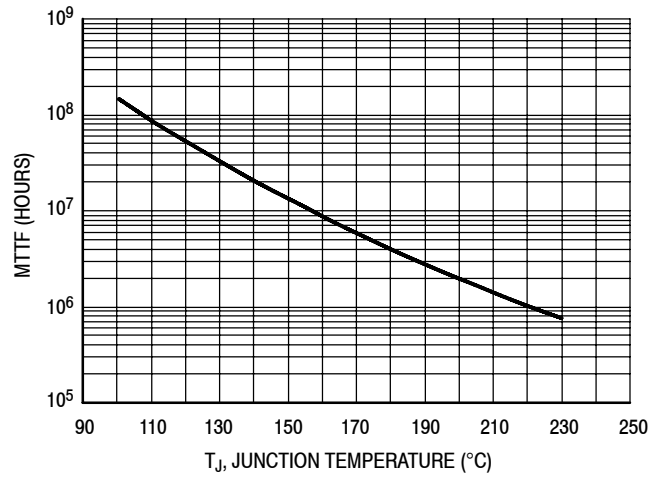

Figure 18. Single-Carrier DVB-T OFDM ACPR Power Gain and Drain Efficiency versus Output Power

TYPICAL CHARACTERISTICS



This above graph displays calculated MTTF in hours when the device is operated at $V_{DD} = 50$ Vdc, $P_{out} = 125$ W Avg., and $\eta_D = 28.5\%$.

MTTF calculator available at <http://www.freescale.com/rf>. Select Software & Tools/Development Tools/Calculators to access MTTF calculators by product.

Figure 19. MTTF versus Junction Temperature - CW

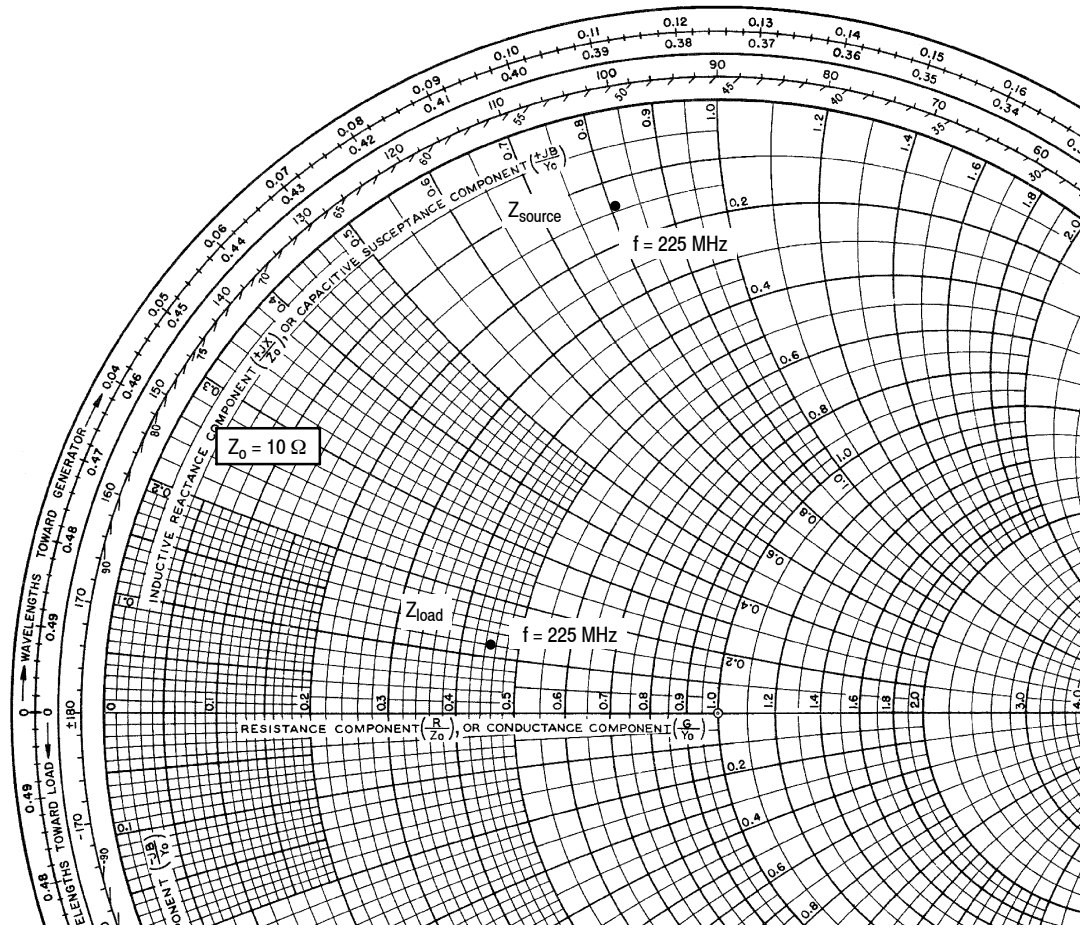

$V_{DD} = 50 \text{ Vdc}$, $I_{DQ} = 2600 \text{ mA}$, $P_{out} = 125 \text{ W Avg.}$

f MHz	Z_{source} Ω	Z_{load} Ω
225	$1.42 + j8.09$	$4.45 + j1.16$

Z_{source} = Test circuit impedance as measured from gate to gate, balanced configuration.

Z_{load} = Test circuit impedance as measured from drain to drain, balanced configuration.

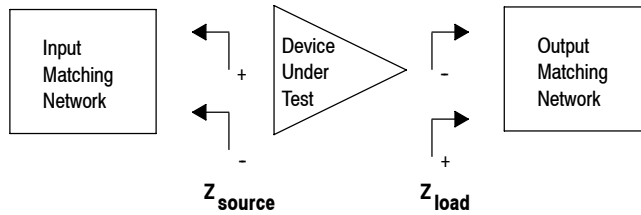

Figure 20. Series Equivalent Source and Load Impedance

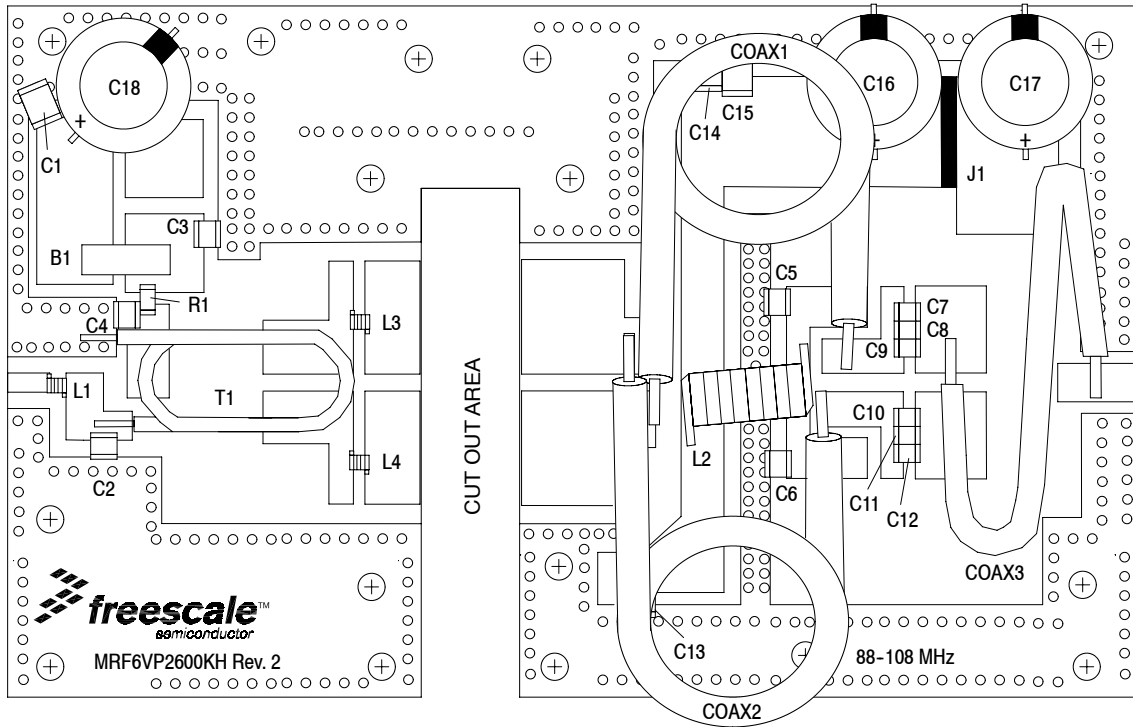

Figure 21. MRF6VP2600HR6 Test Circuit Component Layout — 88-108 MHz

Table 6. MRF6VP2600HR6 Test Circuit Component Designations and Values — 88-108 MHz

Part	Description	Part Number	Manufacturer
B1	95 Ω , 100 MHz Long Ferrite Bead	2743021447	Fair-Rite
C1	6.8 μ F, 50 V Chip Capacitor	C4532X7R1H685K	TDK
C2	30 pF Chip Capacitor	ATC100B300JT500XT	ATC
C3, C13, C14	1000 pF Chip Capacitors	ATC100B102JT50XT	ATC
C4, C5, C6	1 μ F, 100 V Chip Capacitors	GRM31CR72A105KA01L	Murata
C7, C8, C9, C10, C11, C12	3900 pF Chip Capacitors	ATC700B392JT50X	ATC
C15	4.7 μ F, 100 V Chip Capacitor	GRM55ER72A475KA01B	Murata
C16, C17	470 μ F, 63 V Electrolytic Capacitors	MCGPR63V477M13X26-RH	Multicomp
C18	220 μ F, 100 V Electrolytic Capacitor	MCGPR100V227M16X26-RH	Multicomp
J1	Jumper with Copper Tape		
L1	82 nH Inductor	1812SMS-82NJ	CoilCraft
L2	8 Turn, #14 AWG ID=0.250" Inductor, Hand Wound	Copper Wire	Freescale
L3, L4	8 nH Inductors	A03TKLC	CoilCraft
R1	15 Ω , 1/4 W Chip Resistor	CRCW120615R0FKEA	Vishay
T1	Balun Transformer	TUI-LF-9	Comm Concepts
Coax1, Coax2	25 Ω , Semi Rigid RF Cable, 3 mm Line, 16 cm Length	UT-141C-25	Micro-Coax
Coax3	25 Ω , Semi Rigid RF Cable, 3 mm Line, 15 cm Length	UT-141C-25	Micro-Coax
PCB	0.030", $\epsilon_r = 2.55$	GX0300-55-22	Arlon

TYPICAL CHARACTERISTICS — 88-108 MHz

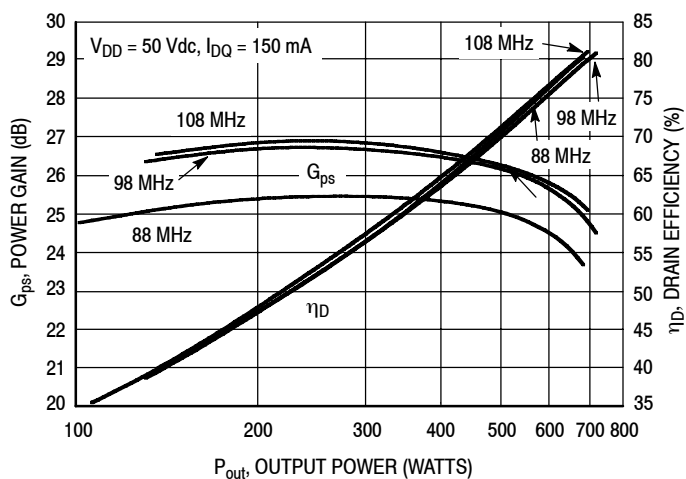

Figure 22. Broadband CW Power Gain and Drain Efficiency versus Output Power — 88-108 MHz

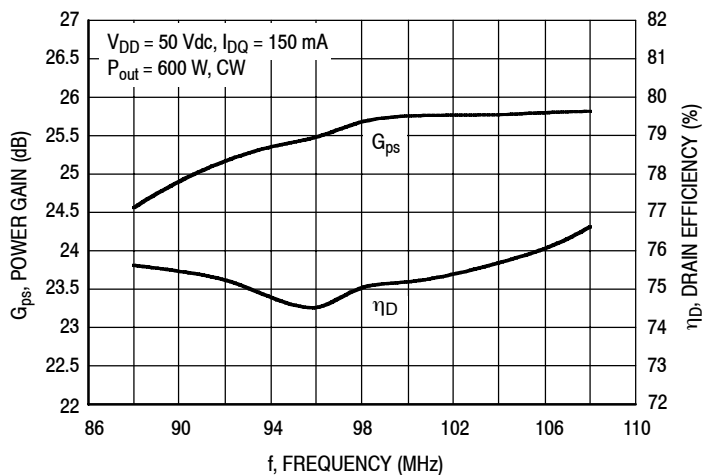
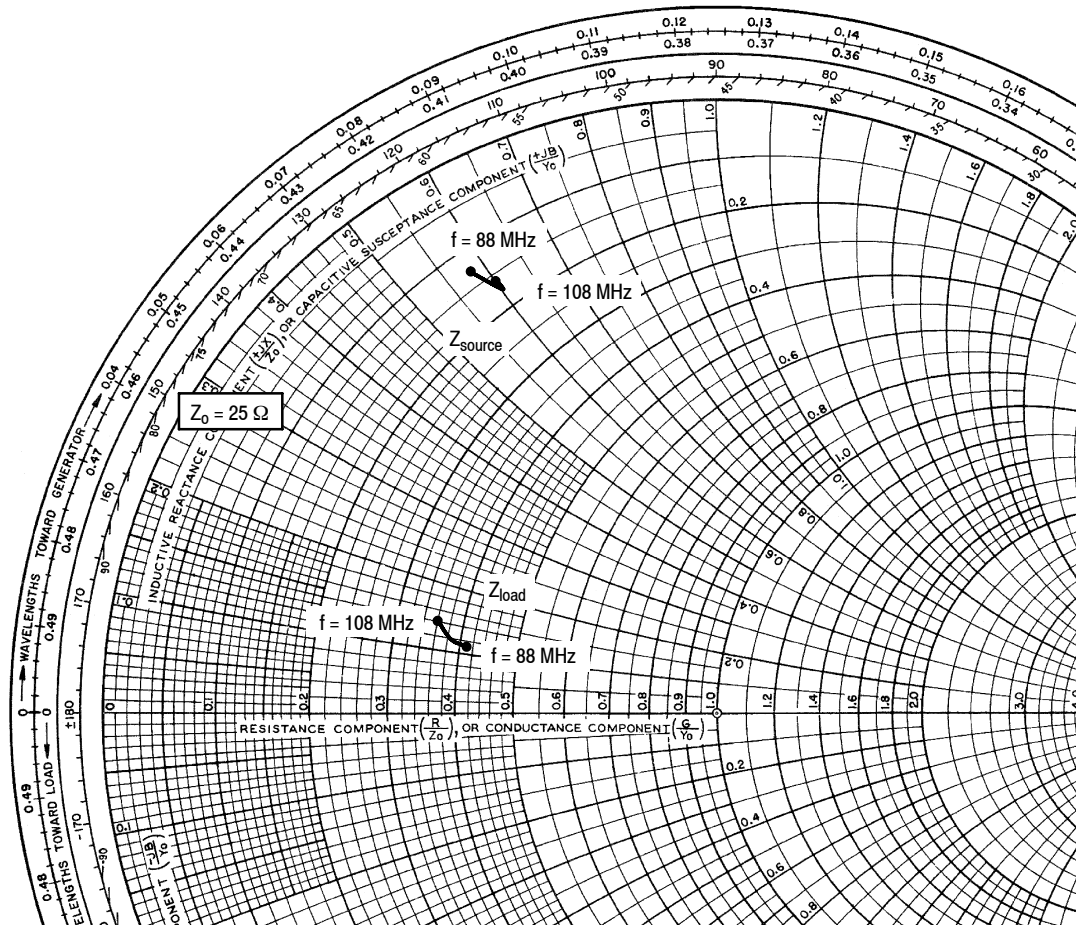

Figure 23. CW Power Gain and Drain Efficiency versus Frequency — 88-108 MHz



$V_{DD} = 50 \text{ Vdc}$, $I_{DQ} = 150 \text{ mA}$, $P_{out} = 600 \text{ W Avg.}$

f MHz	Z_{source} Ω	Z_{load} Ω
88	$3.20 + j14.50$	$10.35 + j2.80$
98	$4.20 + j15.00$	$9.50 + j3.00$
108	$4.00 + j15.00$	$8.90 + j3.50$

Z_{source} = Test circuit impedance as measured from gate to gate, balanced configuration.

Z_{load} = Test circuit impedance as measured from drain to drain, balanced configuration.

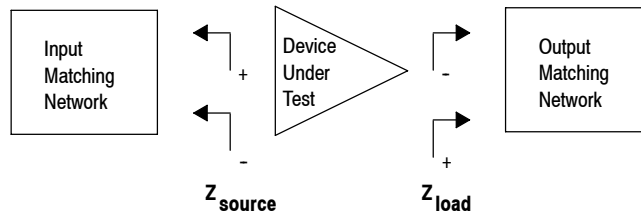
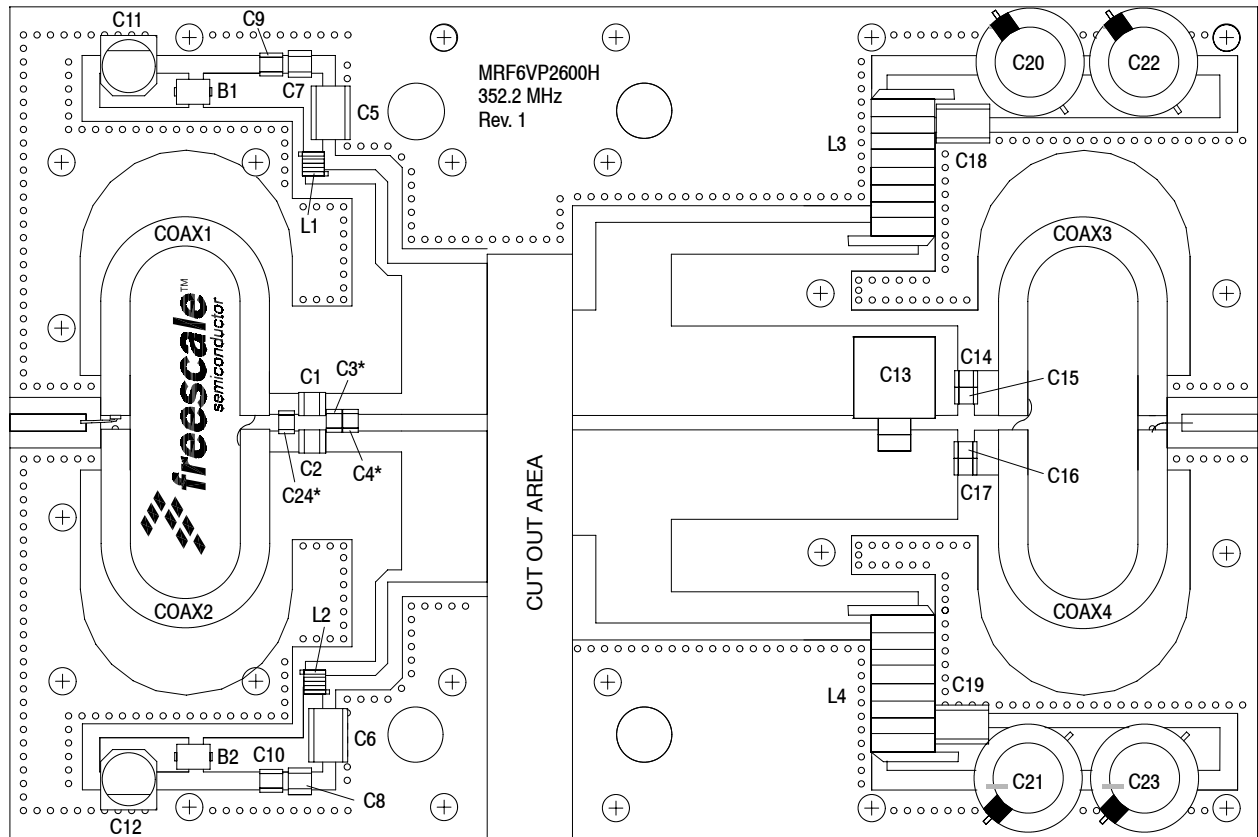

Figure 24. Series Equivalent Source and Load Impedance — 88-108 MHz



*Mounted on side

Figure 25. MRF6VP2600HR6 Test Circuit Component Layout — 352.2 MHz

Table 7. MRF6VP2600HR6 Test Circuit Component Designations and Values — 352.2 MHz

Part	Description	Part Number	Manufacturer
B1, B2	47 Ω , 100 MHz Short Ferrite Beads	2743019447	Fair-Rite
C1, C2	100 pF Chip Capacitors	ATC100B101JT500XT	ATC
C3*, C24*	22 pF Chip Capacitors	ATC100B221JT300XT	ATC
C4*	20 pF Chip Capacitor	ATC100B200JT500XT	ATC
C5, C6	2.2 μ F Chip Capacitors	C1825C225J5RAC-TU	Kemet
C7, C8	220 nF Chip Capacitors	C1812C224K5RAC-TU	Kemet
C9, C10	0.1 μ F Chip Capacitors	CDR33BX104AKWS	AVX
C11, C12	47 μ F, 50 V Electrolytic Capacitors	476KXM050M	Illinois Cap
C13	39 pF, 500 V Chip Capacitor	MCM01-009DD390J-F	CDE
C14, C15, C16, C17	240 pF Chip Capacitors	ATC100B241JT200XT	ATC
C18, C19	2.2 μ F Chip Capacitors	G2225X7R225KT3AB	ATC
C20, C21, C22, C23	470 μ F, 63 V Electrolytic Capacitors	MCGPR63V477M13X26-RH	Multicomp
Coax1, 2, 3, 4	25 Ω , Semi Rigid Coax, 2.2"	UT141-25	Precision Tube Company
L1, L2	2.5 nH, 1 Turn Inductors	A01TKLC	Coilcraft
L3, L4	10 Turn, #16 AWG ID=0.160" Inductors, Hand Wound	Copper Wire	Freescale

*Mounted on side

TYPICAL CHARACTERISTICS — 352.2 MHz

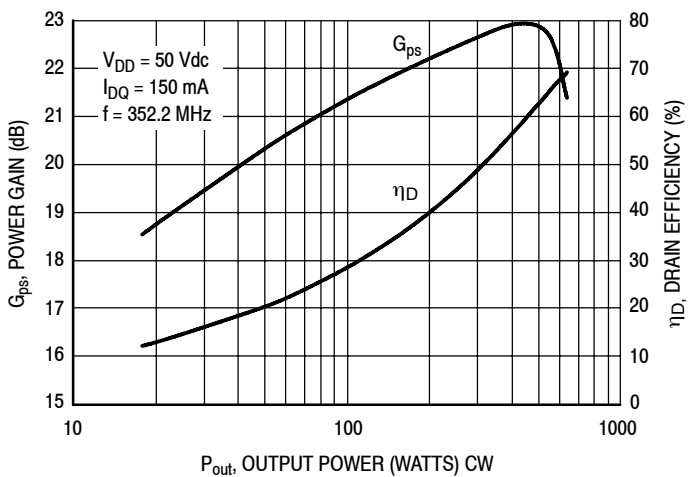
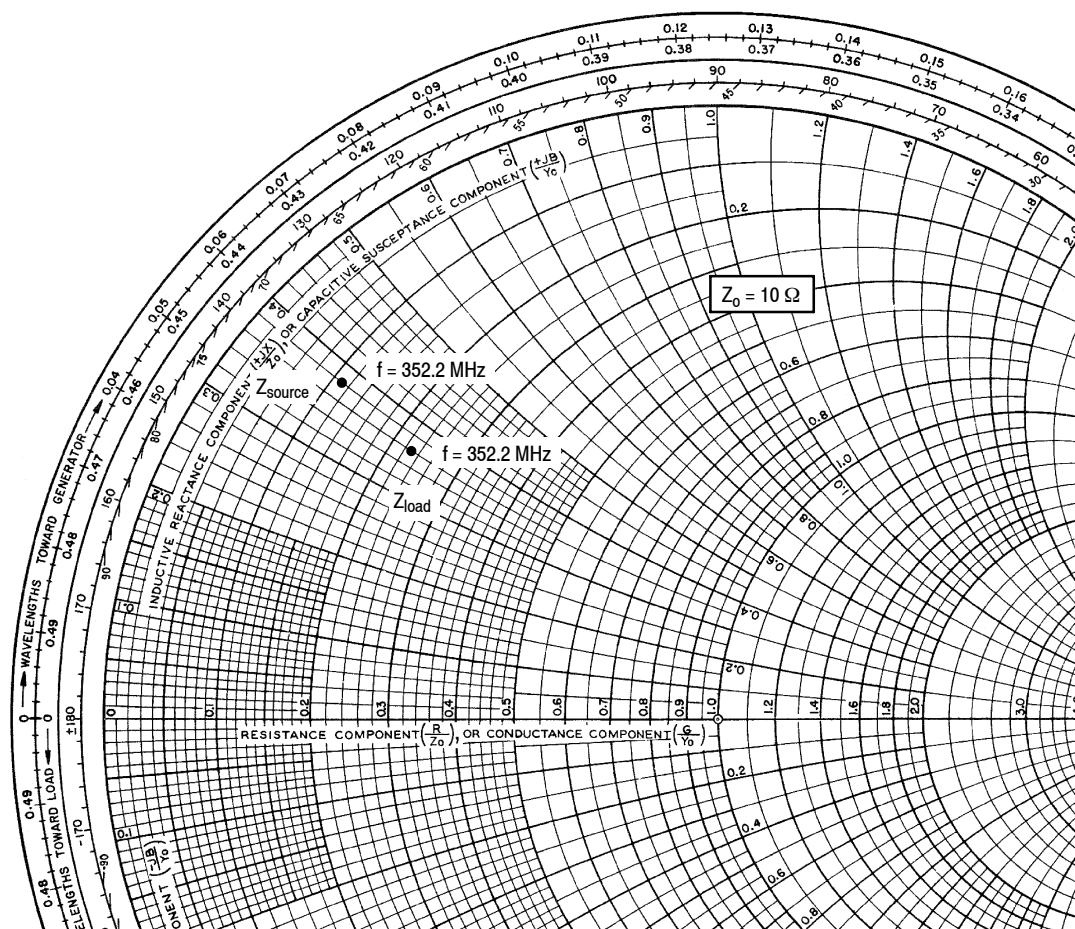

Figure 26. CW Power Gain and Drain Efficiency versus Output Power



$V_{DD} = 50 \text{ Vdc}$, $I_{DQ} = 150 \text{ mA}$, $P_{out} = 600 \text{ W CW}$

f MHz	Z_{source} Ω	Z_{load} Ω
352.2	$1.10 + j3.80$	$2.26 + j3.57$

Z_{source} = Test circuit impedance as measured from gate to gate, balanced configuration.

Z_{load} = Test circuit impedance as measured from drain to drain, balanced configuration.

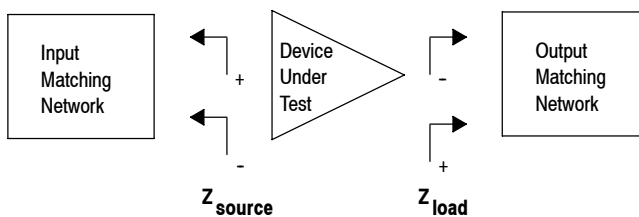
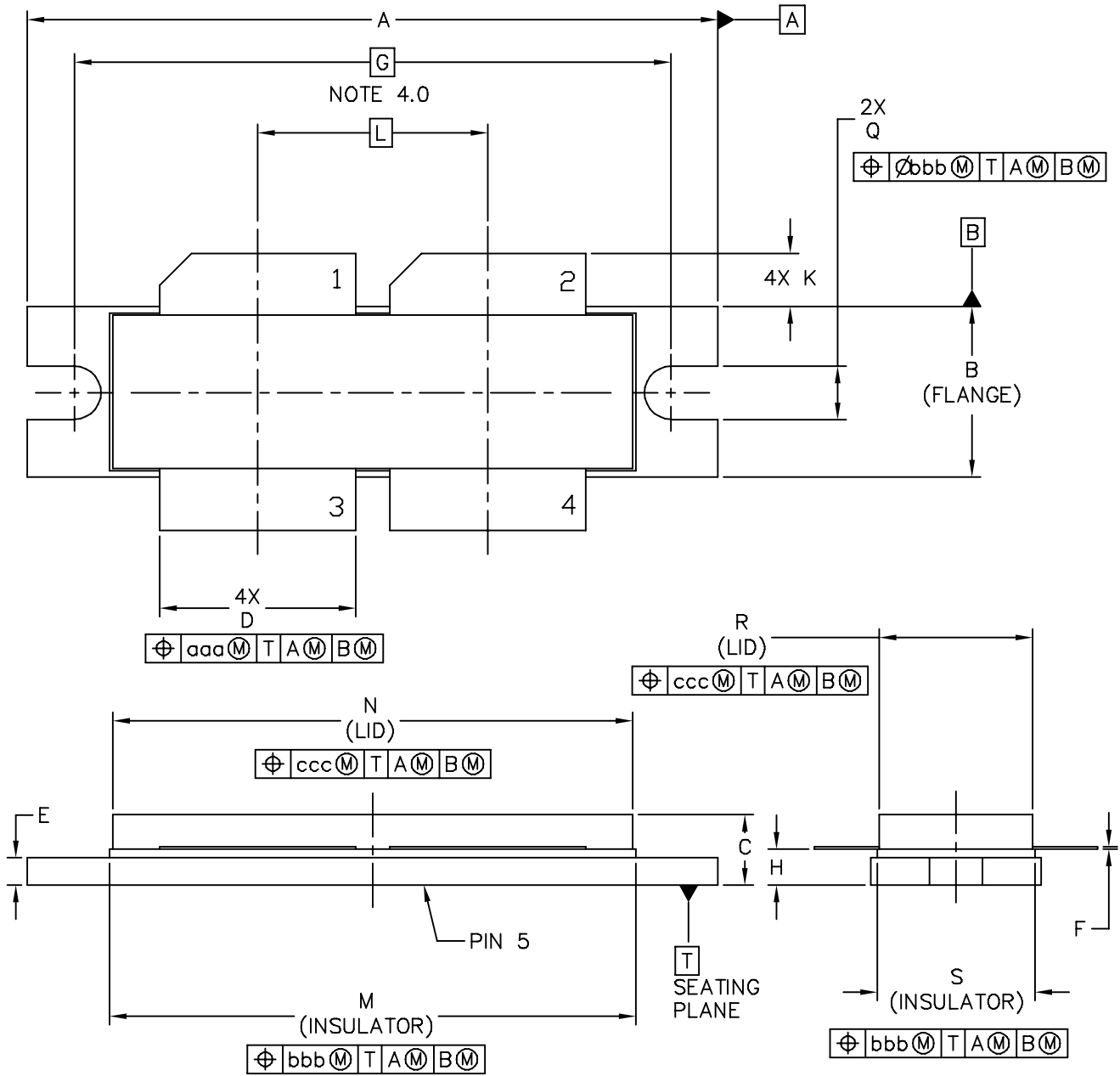

Figure 27. Series Equivalent Source and Load Impedance — 352.2 MHz

PACKAGE DIMENSIONS



© FREESCALE SEMICONDUCTOR, INC. ALL RIGHTS RESERVED.	MECHANICAL OUTLINE	PRINT VERSION NOT TO SCALE	
TITLE: NI-1230	DOCUMENT NO: 98ASB16977C	REV: E	
	CASE NUMBER: 375D-05	31 MAR 2005	
	STANDARD: NON-JEDEC		

NOTES:

- 1.0 INTERPRET DIMENSIONS AND TOLERANCES PER ASME Y14.5M-1994.
- 2.0 CONTROLLING DIMENSION: INCH
- 3.0 DIMENSION H IS MEASURED .030 (0.762) AWAY FROM PACKAGE BODY.
- 4.0 RECOMMENDED BOLT CENTER DIMENSION OF 1.52 (38.61) BASED ON M3 SCREW.

STYLE 1:

- PIN 1 - DRAIN
- 2 - DRAIN
- 3 - GATE
- 4 - GATE
- 5 - SOURCE

DIM	INCH		MILLIMETER		DIM	INCH		MILLIMETER	
	MIN	MAX	MIN	MAX		MIN	MAX	MIN	MAX
A	1.615	1.625	41.02	41.28	N	1.218	1.242	30.94	31.55
B	.395	.405	10.03	10.29	Q	.120	.130	3.05	3.3
C	.150	.200	3.81	5.08	R	.355	.365	9.01	9.27
D	.455	.465	11.56	11.81	S	.365	.375	9.27	9.53
E	.062	.066	1.57	1.68					
F	.004	.007	0.1	0.18					
G	1.400 BSC		35.56 BSC		aaa	.013		0.33	
H	.082	.090	2.08	2.29	bbb	.010		0.25	
K	.117	.137	2.97	3.48	ccc	.020		0.51	
L	.540 BSC		13.72 BSC						
M	1.219	1.241	30.96	31.52					

© FREESCALE SEMICONDUCTOR, INC. ALL RIGHTS RESERVED.		MECHANICAL OUTLINE		PRINT VERSION NOT TO SCALE	
TITLE: NI-1230			DOCUMENT NO: 98ASB16977C		REV: E
			CASE NUMBER: 375D-05		31 MAR 2005
			STANDARD: NON-JEDEC		

Refer to the following documents to aid your design process.

Application Notes

- AN1955: Thermal Measurement Methodology of RF Power Amplifiers

Engineering Bulletins

- EB212: Using Data Sheet Impedances for RF LDMOS Devices

Software

- Electromigration MTTF Calculator
- RF High Power Model

For Software, do a Part Number search at <http://www.freescale.com>, and select the “Part Number” link. Go to the Software & Tools tab on the part’s Product Summary page to download the respective tool.

REVISION HISTORY

The following table summarizes revisions to this document.

Revision	Date	Description
0	Mar. 2008	• Initial Release of Data Sheet
1	July 2008	<ul style="list-style-type: none"> • Removed Capable of Handling 5:1 VSWR bullet, p. 1 • Corrected Z_{source} and Z_{load} values from $1.58 + j6.47$ to $1.42 + j8.09$ and $4.60 + j1.85$ to $4.45 + j1.16$ and re-plotted data in Fig. 21, Series Equivalent Source and Load Impedance, p. 9
2	Sept. 2008	<ul style="list-style-type: none"> • Added Note to Fig. 4, Capacitance versus Drain-Source Voltage and Fig. 5, DC Safe Operating Area to denote that each side of device is measured separately, p. 5 • Updated Fig. 5, DC Safe Operating Area, to show one side of the device, p. 5 • Figs. 21 and 27, Series Equivalent Source and Load Impedance, corrected Z_{source} copy to read “Test circuit impedance as measured from gate to gate, balanced configuration” and Z_{load} copy to read “Test circuit impedance as measured from gate to gate, balanced configuration”, p. 9, 14
2.1	Nov. 2008	• Corrected Figs. 21 and 27 Revision History Z_{load} copy to read “Test circuit impedance as measured from drain to drain, balanced configuration”, p. 9, 14
4	May 2009	<ul style="list-style-type: none"> • Updated bullets in Features section to reflect consistent listing across products, p. 1 • Added thermal data for 352.2 MHz application to Table 2, Thermal Characteristics, p. 1 • Added Typical Performances table for 352.2 MHz application, p. 2 • Added Fig. 28, Test Circuit Component Layout - 352.2 MHz and Table 7, Test Circuit Component Designations and Values - 352.2 MHz, p. 15 • Added Fig. 29, CW Power Gain and Drain Efficiency versus Output Power - 352.2 MHz p. 16 • Added Fig. 30, Series Equivalent Source and Load Impedance - 352.2 MHz, p. 17
4.1	June 2009	<ul style="list-style-type: none"> • Changed “EKME630ELL471MK25S” part number to “MCGPR63V477M13X26-RH”, Table 5, Test Circuit Component Designations and Values and Table 6, Test Circuit Component Designations and Values — 88-108 MHz, p. 3, 11 • Added Electromigration MTTF Calculator and RF High Power Model availability to Product Documentation, Tools and Software, p. 20
5	May 2010	<ul style="list-style-type: none"> • Changed 10-500 MHz to 2-500 MHz in Device Description box, p. 1 • Operating Junction Temperature increased from 200°C to 225°C in Maximum Ratings table and related “Continuous use at maximum temperature will affect MTTF” footnote added, p. 1 • Added thermal data for 88-108 MHz application to Thermal Characteristics table, p. 1 • Added Typical Performance table for 88-108 MHz application, p. 2 • Removed Fig. 20, MTTF versus Junction Temperature - Pulsed and renumbered accordingly, p. 8 • Replaced Fig. 22 Test Circuit Component Layout, Table 6. Test Circuit Component Designations and Values, the Typical Characteristic curves and Fig. 27 Series Impedance for 88-108 MHz with improved circuit performance figures. The 88-108 MHz application circuit is also now a more compact size., p. 10-12
5.1	July 2010	• Fig. 24, Series Impedance for 88-108 MHz, table and plot updated to reflect correct location of Z_{source} and Z_{load} . p. 12

How to Reach Us:

Home Page:

www.freescale.com

Web Support:

<http://www.freescale.com/support>

USA/Europe or Locations Not Listed:

Freescale Semiconductor, Inc.
Technical Information Center, EL516
2100 East Elliot Road
Tempe, Arizona 85284
1-800-521-6274 or +1-480-768-2130
www.freescale.com/support

Europe, Middle East, and Africa:

Freescale Halbleiter Deutschland GmbH
Technical Information Center
Schatzbogen 7
81829 Muenchen, Germany
+44 1296 380 456 (English)
+46 8 52200080 (English)
+49 89 92103 559 (German)
+33 1 69 35 48 48 (French)
www.freescale.com/support

Japan:

Freescale Semiconductor Japan Ltd.
Headquarters
ARCO Tower 15F
1-8-1, Shimo-Meguro, Meguro-ku,
Tokyo 153-0064
Japan
0120 191014 or +81 3 5437 9125
support.japan@freescale.com

Asia/Pacific:

Freescale Semiconductor China Ltd.
Exchange Building 23F
No. 118 Jianguo Road
Chaoyang District
Beijing 100022
China
+86 10 5879 8000
support.asia@freescale.com

For Literature Requests Only:

Freescale Semiconductor Literature Distribution Center
1-800-441-2447 or +1-303-675-2140
Fax: +1-303-675-2150
LDCForFreescaleSemiconductor@hibbertgroup.com

Information in this document is provided solely to enable system and software implementers to use Freescale Semiconductor products. There are no express or implied copyright licenses granted hereunder to design or fabricate any integrated circuits or integrated circuits based on the information in this document.

Freescale Semiconductor reserves the right to make changes without further notice to any products herein. Freescale Semiconductor makes no warranty, representation or guarantee regarding the suitability of its products for any particular purpose, nor does Freescale Semiconductor assume any liability arising out of the application or use of any product or circuit, and specifically disclaims any and all liability, including without limitation consequential or incidental damages. "Typical" parameters that may be provided in Freescale Semiconductor data sheets and/or specifications can and do vary in different applications and actual performance may vary over time. All operating parameters, including "Typicals", must be validated for each customer application by customer's technical experts. Freescale Semiconductor does not convey any license under its patent rights nor the rights of others. Freescale Semiconductor products are not designed, intended, or authorized for use as components in systems intended for surgical implant into the body, or other applications intended to support or sustain life, or for any other application in which the failure of the Freescale Semiconductor product could create a situation where personal injury or death may occur. Should Buyer purchase or use Freescale Semiconductor products for any such unintended or unauthorized application, Buyer shall indemnify and hold Freescale Semiconductor and its officers, employees, subsidiaries, affiliates, and distributors harmless against all claims, costs, damages, and expenses, and reasonable attorney fees arising out of, directly or indirectly, any claim of personal injury or death associated with such unintended or unauthorized use, even if such claim alleges that Freescale Semiconductor was negligent regarding the design or manufacture of the part.

Freescale™ and the Freescale logo are trademarks of Freescale Semiconductor, Inc. All other product or service names are the property of their respective owners.

© Freescale Semiconductor, Inc. 2008-2010. All rights reserved.

Mouser Electronics

Authorized Distributor

Click to View Pricing, Inventory, Delivery & Lifecycle Information:

[Freescale Semiconductor:](#)

[MRF6VP2600HR6](#) [MRF6VP2600HR5](#)