

PMBTA42DS

NPN/NPN high-voltage double transistors

Rev. 02 — 27 August 2009

Product data sheet

1. Product profile

1.1 General description

NPN/NPN high-voltage double transistors in a small SOT457 (SC-74) Surface Mounted Device (SMD) plastic package.

1.2 Features

- High breakdown voltage
- Two electrically isolated transistors
- Small SMD plastic package

1.3 Applications

- Automotive:
 - ◆ High- and low-side switches
 - ◆ Voltage regulators
- Communication: Telecom line interface
- Consumer: CRT TV
- Computing: Monitors

1.4 Quick reference data

Table 1. Quick reference data

Symbol	Parameter	Conditions	Min	Typ	Max	Unit
Per transistor						
V_{CEO}	collector-emitter voltage	open base	-	-	300	V
I_C	collector current		-	-	100	mA
I_{CM}	peak collector current	single pulse; $t_p \leq 1$ ms	-	-	200	mA

2. Pinning information

Table 2. Pinning

Pin	Description	Simplified outline	Symbol
1	emitter TR1		
2	base TR2		
3	collector TR2		
4	emitter TR2		
5	base TR1		
6	collector TR1		

006aaa677

3. Ordering information

Table 3. Ordering information

Type number	Package		
	Name	Description	Version
PMBTA42DS	SC-74	plastic surface mounted package (TSOP6); 6 leads	SOT457

4. Marking

Table 4. Marking codes

Type number	Marking code
PMBTA42DS	P4

5. Limiting values

Table 5. Limiting values

In accordance with the Absolute Maximum Rating System (IEC 60134).

Symbol	Parameter	Conditions	Min	Max	Unit	
Per transistor						
V_{CBO}	collector-base voltage	open emitter	-	300	V	
V_{CEO}	collector-emitter voltage	open base	-	300	V	
V_{EBO}	emitter-base voltage	open collector	-	6	V	
I_C	collector current		-	100	mA	
I_{CM}	peak collector current	single pulse; $t_p \leq 1$ ms	-	200	mA	
I_{BM}	peak base current	single pulse; $t_p \leq 1$ ms	-	100	mA	
P_{tot}	total power dissipation	$T_{amb} \leq 25$ °C	[1]	-	290	mW
			[2]	-	370	mW
			[3]	-	450	mW

Table 5. Limiting values ...continued
In accordance with the Absolute Maximum Rating System (IEC 60134).

Symbol	Parameter	Conditions	Min	Max	Unit	
Per device						
P _{tot}	total power dissipation	T _{amb} ≤ 25 °C	[1]	-	420	mW
			[2]	-	560	mW
			[3]	-	700	mW
T _j	junction temperature		-	150	°C	
T _{amb}	ambient temperature		-65	+150	°C	
T _{stg}	storage temperature		-65	+150	°C	

- [1] Device mounted on an FR4 Printed-Circuit Board (PCB), single-sided copper, tin-plated and standard footprint.
- [2] Device mounted on an FR4 PCB, single-sided copper, tin-plated, mounting pad for collector 1cm².
- [3] Device mounted on a ceramic PCB, Al₂O₃, standard footprint.

6. Thermal characteristics

Table 6. Thermal characteristics

Symbol	Parameter	Conditions	Min	Typ	Max	Unit
Per transistor						
R _{th(j-a)}	thermal resistance from junction to ambient	in free air	[1]	-	431	K/W
			[2]	-	338	K/W
			[3]	-	278	K/W
R _{th(j-sp)}	thermal resistance from junction to solder point		-	-	105	K/W
Per device						
R _{th(j-a)}	thermal resistance from junction to ambient	in free air	[1]	-	298	K/W
			[2]	-	223	K/W
			[3]	-	179	K/W

- [1] Device mounted on an FR4 PCB, single-sided copper, tin-plated and standard footprint.
- [2] Device mounted on an FR4 PCB, single-sided copper, tin-plated, mounting pad for collector 1cm².
- [3] Device mounted on a ceramic PCB, Al₂O₃, standard footprint.

7. Characteristics

Table 7. Characteristics

$T_{amb} = 25\text{ }^\circ\text{C}$ unless otherwise specified

Symbol	Parameter	Conditions	Min	Typ	Max	Unit
Per transistor						
I_{CBO}	collector-base cut-off current	$V_{CB} = 200\text{ V}; I_E = 0\text{ A}$	-	-	100	nA
I_{EBO}	emitter-base cut-off current	$V_{EB} = 6\text{ V}; I_C = 0\text{ A}$	-	-	100	nA
h_{FE}	DC current gain	$V_{CE} = 10\text{ V}; I_C = 1\text{ mA}$	25	-	-	
		$V_{CE} = 10\text{ V}; I_C = 10\text{ mA}$	40	-	-	
		$V_{CE} = 10\text{ V}; I_C = 30\text{ mA}$	40	-	-	
V_{CEsat}	collector-emitter saturation voltage	$I_C = 20\text{ mA}; I_B = 2\text{ mA}$	-	-	500	mV
V_{BEsat}	base-emitter saturation voltage	$I_C = 20\text{ mA}; I_B = 2\text{ mA}$	-	-	900	mV
C_{re}	feedback capacitance	$V_{CB} = 20\text{ V}; I_C = i_c = 0\text{ A}; f = 1\text{ MHz}$	-	-	3	pF
f_T	transition frequency	$V_{CE} = 20\text{ V}; I_C = 10\text{ mA}; f = 100\text{ MHz}$	50	-	-	MHz

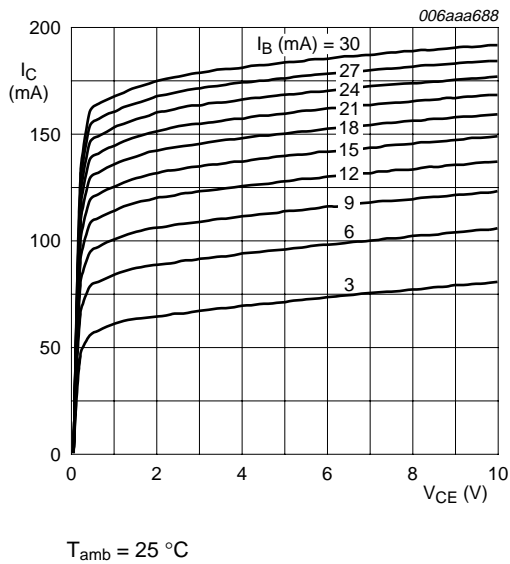
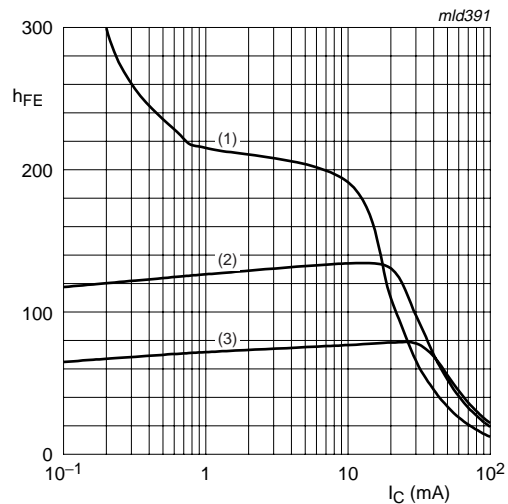
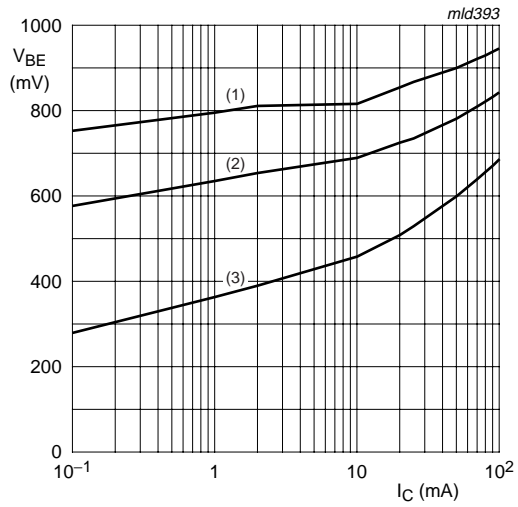

Fig 1. Collector current as a function of collector-emitter voltage; typical values



$V_{CE} = 10\text{ V}$
 (1) $T_{amb} = 150\text{ }^\circ\text{C}$
 (2) $T_{amb} = 25\text{ }^\circ\text{C}$
 (3) $T_{amb} = -55\text{ }^\circ\text{C}$

Fig 2. DC current gain as a function of collector current; typical values



$V_{CE} = 10\text{ V}$
 (1) $T_{amb} = -55\text{ °C}$
 (2) $T_{amb} = 25\text{ °C}$
 (3) $T_{amb} = 150\text{ °C}$

Fig 3. Base-emitter voltage as a function of collector current; typical values

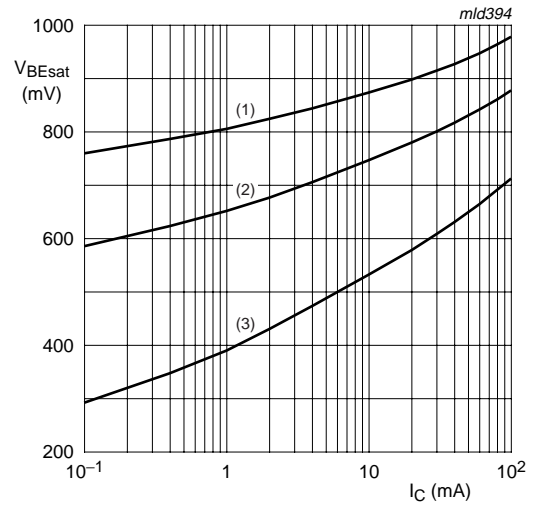

$I_C/I_B = 10$
 (1) $T_{amb} = -55\text{ °C}$
 (2) $T_{amb} = 25\text{ °C}$
 (3) $T_{amb} = 150\text{ °C}$

Fig 4. Base-emitter saturation voltage as a function of collector current, typical values

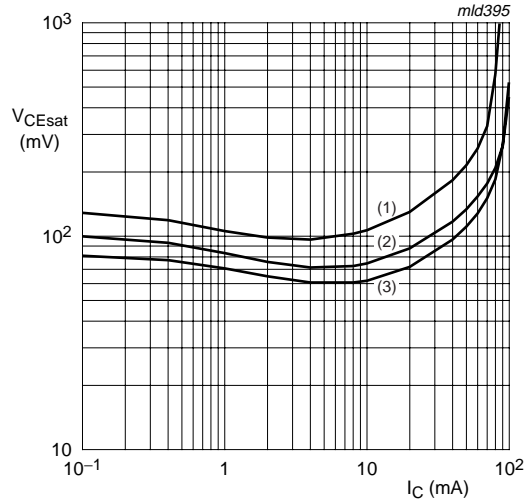

$I_C/I_B = 10$
 (1) $T_{amb} = 150\text{ °C}$
 (2) $T_{amb} = 25\text{ °C}$
 (3) $T_{amb} = -55\text{ °C}$

Fig 5. Collector-emitter saturation voltage as a function of collector current; typical values

8. Package outline

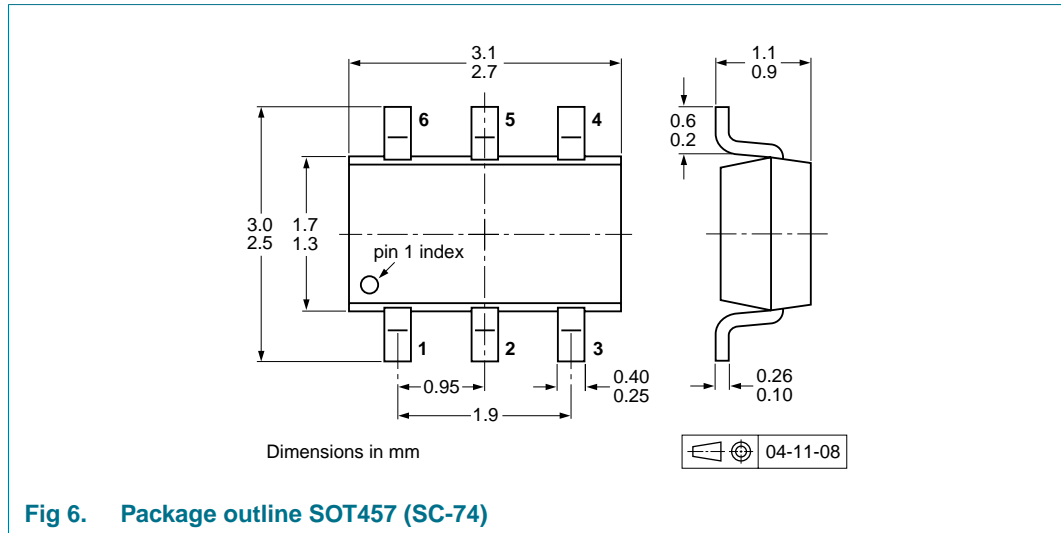

9. Packing information

Table 8. Packing methods

The indicated -xxx are the last three digits of the 12NC ordering code.^[1]

Type number	Package	Description	Packing quantity	
			3000	10000
PMBTA42DS	SOT457	4 mm pitch, 8 mm tape and reel; T1	[2] -115	-135
		4 mm pitch, 8 mm tape and reel; T2	[3] -125	-165

[1] For further information and the availability of packing methods, see [Section 13](#).

[2] T1: normal taping

[3] T2: reverse taping

10. Soldering

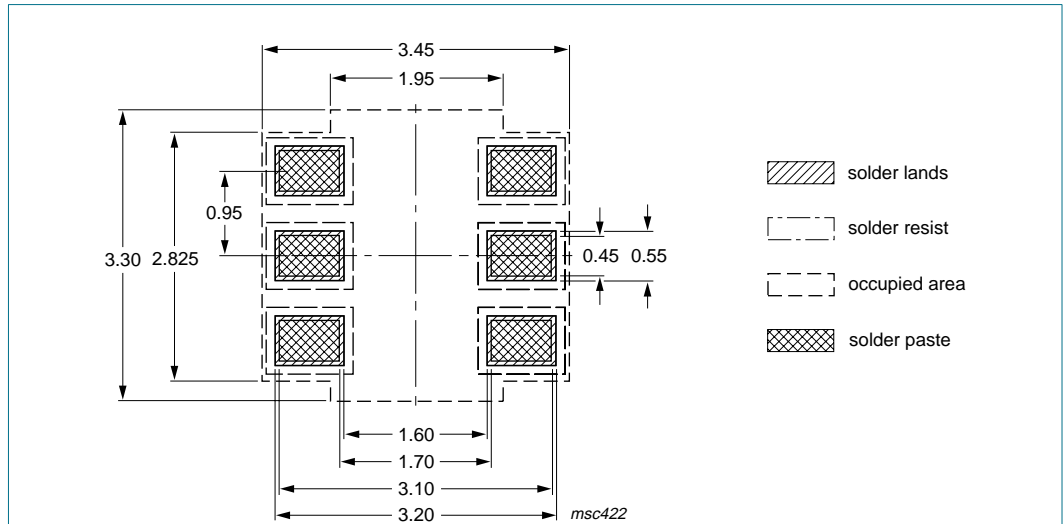

Dimensions in mm

Fig 7. Reflow soldering footprint SOT457 (SC-74)

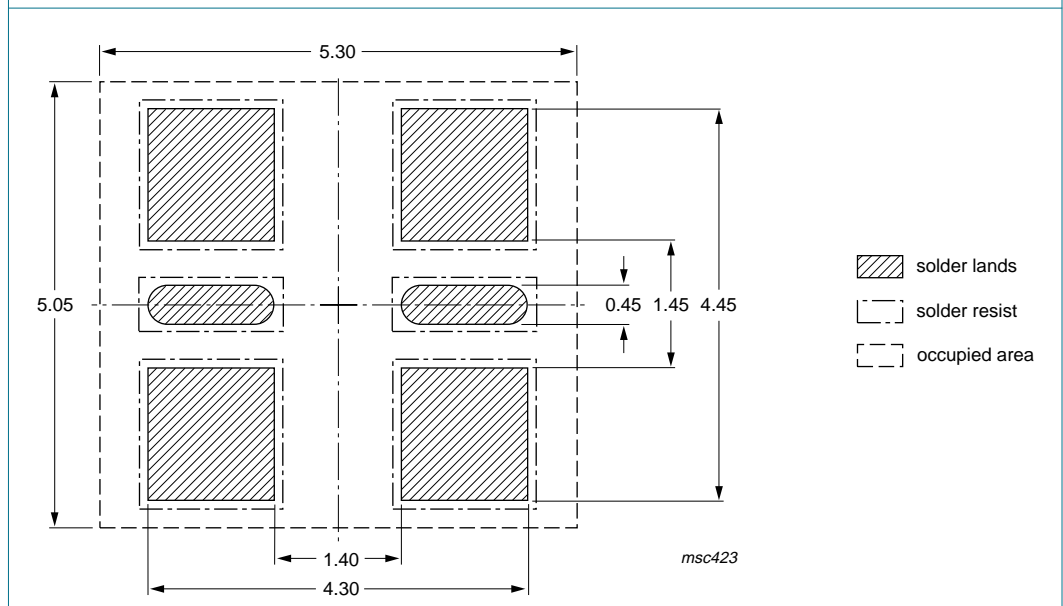

Dimensions in mm

Fig 8. Wave soldering footprint SOT457 (SC-74)

11. Revision history

Table 9. Revision history

Document ID	Release date	Data sheet status	Change notice	Supersedes
PMBTA42DS_2	20090827	Product data sheet	-	PMBTA42DS_1
Modifications:		<ul style="list-style-type: none">This data sheet was changed to reflect the new company name NXP Semiconductors, including new legal definitions and disclaimers. No changes were made to the technical content.Figure 8 "Wave soldering footprint SOT457 (SC-74)":updated		
PMBTA42DS_1	20060106	Product data sheet	-	-

12. Legal information

12.1 Data sheet status

Document status ^{[1][2]}	Product status ^[3]	Definition
Objective [short] data sheet	Development	This document contains data from the objective specification for product development.
Preliminary [short] data sheet	Qualification	This document contains data from the preliminary specification.
Product [short] data sheet	Production	This document contains the product specification.

[1] Please consult the most recently issued document before initiating or completing a design.

[2] The term 'short data sheet' is explained in section "Definitions".

[3] The product status of device(s) described in this document may have changed since this document was published and may differ in case of multiple devices. The latest product status information is available on the Internet at URL <http://www.nxp.com>.

12.2 Definitions

Draft — The document is a draft version only. The content is still under internal review and subject to formal approval, which may result in modifications or additions. NXP Semiconductors does not give any representations or warranties as to the accuracy or completeness of information included herein and shall have no liability for the consequences of use of such information.

Short data sheet — A short data sheet is an extract from a full data sheet with the same product type number(s) and title. A short data sheet is intended for quick reference only and should not be relied upon to contain detailed and full information. For detailed and full information see the relevant full data sheet, which is available on request via the local NXP Semiconductors sales office. In case of any inconsistency or conflict with the short data sheet, the full data sheet shall prevail.

12.3 Disclaimers

General — Information in this document is believed to be accurate and reliable. However, NXP Semiconductors does not give any representations or warranties, expressed or implied, as to the accuracy or completeness of such information and shall have no liability for the consequences of use of such information.

Right to make changes — NXP Semiconductors reserves the right to make changes to information published in this document, including without limitation specifications and product descriptions, at any time and without notice. This document supersedes and replaces all information supplied prior to the publication hereof.

Suitability for use — NXP Semiconductors products are not designed, authorized or warranted to be suitable for use in medical, military, aircraft, space or life support equipment, nor in applications where failure or malfunction of an NXP Semiconductors product can reasonably be expected to result in personal injury, death or severe property or environmental

damage. NXP Semiconductors accepts no liability for inclusion and/or use of NXP Semiconductors products in such equipment or applications and therefore such inclusion and/or use is at the customer's own risk.

Applications — Applications that are described herein for any of these products are for illustrative purposes only. NXP Semiconductors makes no representation or warranty that such applications will be suitable for the specified use without further testing or modification.

Limiting values — Stress above one or more limiting values (as defined in the Absolute Maximum Ratings System of IEC 60134) may cause permanent damage to the device. Limiting values are stress ratings only and operation of the device at these or any other conditions above those given in the Characteristics sections of this document is not implied. Exposure to limiting values for extended periods may affect device reliability.

Terms and conditions of sale — NXP Semiconductors products are sold subject to the general terms and conditions of commercial sale, as published at <http://www.nxp.com/profile/terms>, including those pertaining to warranty, intellectual property rights infringement and limitation of liability, unless explicitly otherwise agreed to in writing by NXP Semiconductors. In case of any inconsistency or conflict between information in this document and such terms and conditions, the latter will prevail.

No offer to sell or license — Nothing in this document may be interpreted or construed as an offer to sell products that is open for acceptance or the grant, conveyance or implication of any license under any copyrights, patents or other industrial or intellectual property rights.

Export control — This document as well as the item(s) described herein may be subject to export control regulations. Export might require a prior authorization from national authorities.

Quick reference data — The Quick reference data is an extract of the product data given in the Limiting values and Characteristics sections of this document, and as such is not complete, exhaustive or legally binding.

12.4 Trademarks

Notice: All referenced brands, product names, service names and trademarks are the property of their respective owners.

13. Contact information

For more information, please visit: <http://www.nxp.com>

For sales office addresses, please send an email to: salesaddresses@nxp.com

14. Contents

1	Product profile	1
1.1	General description	1
1.2	Features	1
1.3	Applications	1
1.4	Quick reference data	1
2	Pinning information	2
3	Ordering information	2
4	Marking	2
5	Limiting values	2
6	Thermal characteristics	3
7	Characteristics	4
8	Package outline	6
9	Packing information	6
10	Soldering	7
11	Revision history	8
12	Legal information	9
12.1	Data sheet status	9
12.2	Definitions	9
12.3	Disclaimers	9
12.4	Trademarks	9
13	Contact information	9
14	Contents	10

Please be aware that important notices concerning this document and the product(s) described herein, have been included in section 'Legal information'.



© NXP B.V. 2009.

All rights reserved.

For more information, please visit: <http://www.nxp.com>

For sales office addresses, please send an email to: salesaddresses@nxp.com

Date of release: 27 August 2009

Document identifier: PMBTA42DS_2

Mouser Electronics

Authorized Distributor

Click to View Pricing, Inventory, Delivery & Lifecycle Information:

[NXP:](#)

[PMBTA42DS,125](#)