

# MUN2131, MMUN2131L, MUN5131, DTA123EE, DTA123EM3, NSBA123EF3

## Digital Transistors (BRT) R1 = 2.2 kΩ, R2 = 2.2 kΩ

### PNP Transistors with Monolithic Bias Resistor Network

This series of digital transistors is designed to replace a single device and its external resistor bias network. The Bias Resistor Transistor (BRT) contains a single transistor with a monolithic bias network consisting of two resistors; a series base resistor and a base-emitter resistor. The BRT eliminates these individual components by integrating them into a single device. The use of a BRT can reduce both system cost and board space.

#### Features

- Simplifies Circuit Design
- Reduces Board Space
- Reduces Component Count
- S and NSV Prefix for Automotive and Other Applications Requiring Unique Site and Control Change Requirements; AEC-Q101 Qualified and PPAP Capable
- These Devices are Pb-Free, Halogen Free/BFR Free and are RoHS Compliant

#### MAXIMUM RATINGS (T<sub>A</sub> = 25°C)

| Rating                         | Symbol               | Max | Unit |
|--------------------------------|----------------------|-----|------|
| Collector-Base Voltage         | V <sub>CBO</sub>     | 50  | Vdc  |
| Collector-Emitter Voltage      | V <sub>CEO</sub>     | 50  | Vdc  |
| Collector Current – Continuous | I <sub>C</sub>       | 100 | mAdc |
| Input Forward Voltage          | V <sub>IN(fwd)</sub> | 12  | Vdc  |
| Input Reverse Voltage          | V <sub>IN(rev)</sub> | 10  | Vdc  |

Stresses exceeding those listed in the Maximum Ratings table may damage the device. If any of these limits are exceeded, device functionality should not be assumed, damage may occur and reliability may be affected.



ON Semiconductor®

[www.onsemi.com](http://www.onsemi.com)

#### PIN CONNECTIONS

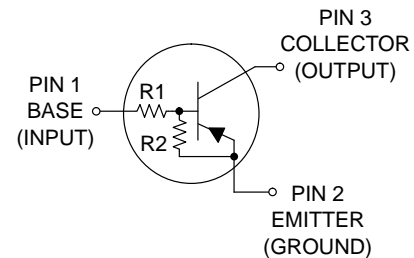

#### MARKING DIAGRAMS

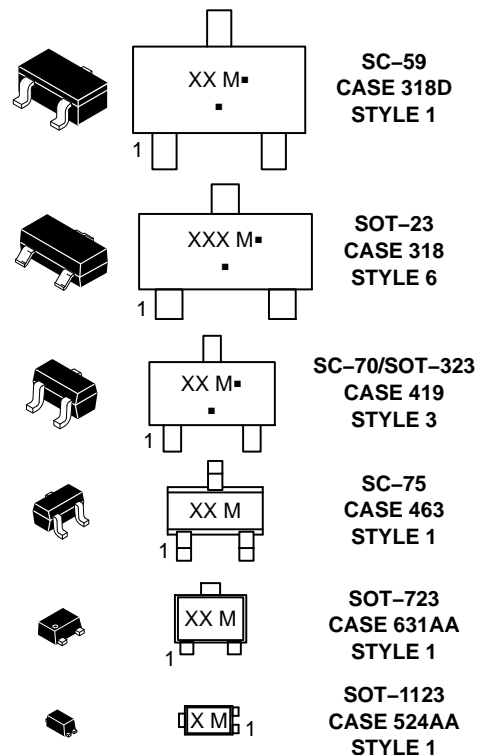

XXX = Specific Device Code  
M = Date Code\*  
▪ = Pb-Free Package

(Note: Microdot may be in either location)

\*Date Code orientation may vary depending upon manufacturing location.

#### ORDERING INFORMATION

See detailed ordering, marking, and shipping information in the package dimensions section on page 2 of this data sheet.

# MUN2131, MMUN2131L, MUN5131, DTA123EE, DTA123EM3, NSBA123EF3

**Table 1. ORDERING INFORMATION**

| Device                         | Part Marking | Package                    | Shipping†          |
|--------------------------------|--------------|----------------------------|--------------------|
| MUN2131T1G                     | 6H           | SC-59<br>(Pb-Free)         | 3000 / Tape & Reel |
| MMUN2131LT1G, NSVMMUN2131LT1G* | A6H          | SOT-23<br>(Pb-Free)        | 3000 / Tape & Reel |
| MUN5131T1G, NSVMUN5131T1G*     | 6H           | SC-70/SOT-323<br>(Pb-Free) | 3000 / Tape & Reel |
| DTA123EET1G                    | 6H           | SC-75<br>(Pb-Free)         | 3000 / Tape & Reel |
| DTA123EM3T5G, NSVDTA123EM3T5G* | 6H           | SOT-723<br>(Pb-Free)       | 8000 / Tape & Reel |
| NSBA123EF3T5G                  | P (180°)**   | SOT-1123<br>(Pb-Free)      | 8000 / Tape & Reel |

†For information on tape and reel specifications, including part orientation and tape sizes, please refer to our Tape and Reel Packaging Specifications Brochure, BRD8011/D.

\*S and NSV Prefix for Automotive and Other Applications Requiring Unique Site and Control Change Requirements; AEC-Q101 Qualified and PPAP Capable.

\*\* (xx°) = Degree rotation in the clockwise direction.



- (1) SC-75 and SC-70/SOT323; Minimum Pad
- (2) SC-59; Minimum Pad
- (3) SOT-23; Minimum Pad
- (4) SOT-1123; 100 mm², 1 oz. copper trace
- (5) SOT-723; Minimum Pad

**Figure 1. Derating Curve**

# MUN2131, MMUN2131L, MUN5131, DTA123EE, DTA123EM3, NSBA123EF3

**Table 2. THERMAL CHARACTERISTICS**

| Characteristic  | Symbol                                       | Max                               | Unit                       |
|---|--|-----------------------------------|----------------------------|
| <b>THERMAL CHARACTERISTICS (SC-59) (MUN2131)</b>  |  |                                   |                            |
| Total Device Dissipation<br>$T_A = 25^\circ\text{C}$<br>Derate above $25^\circ\text{C}$ | (Note 1)<br>(Note 2)<br>(Note 1)<br>(Note 2) | $P_D$<br>230<br>338<br>1.8<br>2.7 | mW<br>mW/ $^\circ\text{C}$ |
| Thermal Resistance,<br>Junction to Ambient  | (Note 1)<br>(Note 2)                         | $R_{\theta JA}$<br>540<br>370     | $^\circ\text{C/W}$         |
| Thermal Resistance,<br>Junction to Lead   | (Note 1)<br>(Note 2)                         | $R_{\theta JL}$<br>264<br>287     | $^\circ\text{C/W}$         |
| Junction and Storage Temperature Range  | $T_J, T_{stg}$                               | -55 to +150                       | $^\circ\text{C}$           |
| <b>THERMAL CHARACTERISTICS (SOT-23) (MMUN2131L)</b>                                     |  |                                   |                            |
| Total Device Dissipation<br>$T_A = 25^\circ\text{C}$<br>Derate above $25^\circ\text{C}$ | (Note 1)<br>(Note 2)<br>(Note 1)<br>(Note 2) | $P_D$<br>246<br>400<br>2.0<br>3.2 | mW<br>mW/ $^\circ\text{C}$ |
| Thermal Resistance,<br>Junction to Ambient  | (Note 1)<br>(Note 2)                         | $R_{\theta JA}$<br>508<br>311     | $^\circ\text{C/W}$         |
| Thermal Resistance,<br>Junction to Lead   | (Note 1)<br>(Note 2)                         | $R_{\theta JL}$<br>174<br>208     | $^\circ\text{C/W}$         |
| Junction and Storage Temperature Range  | $T_J, T_{stg}$                               | -55 to +150                       | $^\circ\text{C}$           |
| <b>THERMAL CHARACTERISTICS (SC-70/SOT-323) (MUN5131)</b>                                |  |                                   |                            |
| Total Device Dissipation<br>$T_A = 25^\circ\text{C}$<br>Derate above $25^\circ\text{C}$ | (Note 1)<br>(Note 2)<br>(Note 1)<br>(Note 2) | $P_D$<br>202<br>310<br>1.6<br>2.5 | mW<br>mW/ $^\circ\text{C}$ |
| Thermal Resistance,<br>Junction to Ambient  | (Note 1)<br>(Note 2)                         | $R_{\theta JA}$<br>618<br>403     | $^\circ\text{C/W}$         |
| Thermal Resistance,<br>Junction to Lead   | (Note 1)<br>(Note 2)                         | $R_{\theta JL}$<br>280<br>332     | $^\circ\text{C/W}$         |
| Junction and Storage Temperature Range  | $T_J, T_{stg}$                               | -55 to +150                       | $^\circ\text{C}$           |
| <b>THERMAL CHARACTERISTICS (SC-75) (DTA123EE)</b>                                       |  |                                   |                            |
| Total Device Dissipation<br>$T_A = 25^\circ\text{C}$<br>Derate above $25^\circ\text{C}$ | (Note 1)<br>(Note 2)<br>(Note 1)<br>(Note 2) | $P_D$<br>200<br>300<br>1.6<br>2.4 | mW<br>mW/ $^\circ\text{C}$ |
| Thermal Resistance,<br>Junction to Ambient  | (Note 1)<br>(Note 2)                         | $R_{\theta JA}$<br>600<br>400     | $^\circ\text{C/W}$         |
| Junction and Storage Temperature Range  | $T_J, T_{stg}$                               | -55 to +150                       | $^\circ\text{C}$           |
| <b>THERMAL CHARACTERISTICS (SOT-723) (DTA123EM3)</b>                                    |  |                                   |                            |
| Total Device Dissipation<br>$T_A = 25^\circ\text{C}$<br>Derate above $25^\circ\text{C}$ | (Note 1)<br>(Note 2)<br>(Note 1)<br>(Note 2) | $P_D$<br>260<br>600<br>2.0<br>4.8 | mW<br>mW/ $^\circ\text{C}$ |
| Thermal Resistance,<br>Junction to Ambient  | (Note 1)<br>(Note 2)                         | $R_{\theta JA}$<br>480<br>205     | $^\circ\text{C/W}$         |
| Junction and Storage Temperature Range  | $T_J, T_{stg}$                               | -55 to +150                       | $^\circ\text{C}$           |

- FR-4 @ Minimum Pad.
- FR-4 @ 1.0 x 1.0 Inch Pad.
- FR-4 @ 100 mm<sup>2</sup>, 1 oz. copper traces, still air.
- FR-4 @ 500 mm<sup>2</sup>, 1 oz. copper traces, still air.

**Table 2. THERMAL CHARACTERISTICS**

| Characteristic   | Symbol          | Max         | Unit                      |
|--|-----------------|-------------|---------------------------|
| <b>THERMAL CHARACTERISTICS (SOT-1123) (NSBA123EF3)</b> |                 |             |                           |
| Total Device Dissipation<br>$T_A = 25^\circ\text{C}$   | $P_D$           | 254<br>297  | mW                        |
| Derate above $25^\circ\text{C}$                        |                 | 2.0<br>2.4  | mW/ $^\circ\text{C}$      |
| Thermal Resistance,<br>Junction to Ambient             | $R_{\theta JA}$ | 493<br>421  | $^\circ\text{C}/\text{W}$ |
| Thermal Resistance, Junction to Lead                   | $R_{\theta JL}$ | 193         | $^\circ\text{C}/\text{W}$ |
| Junction and Storage Temperature Range                 | $T_J, T_{stg}$  | -55 to +150 | $^\circ\text{C}$          |

- FR-4 @ Minimum Pad.
- FR-4 @ 1.0 x 1.0 Inch Pad.
- FR-4 @ 100 mm<sup>2</sup>, 1 oz. copper traces, still air.
- FR-4 @ 500 mm<sup>2</sup>, 1 oz. copper traces, still air.

**Table 3. ELECTRICAL CHARACTERISTICS** ( $T_A = 25^\circ\text{C}$ , unless otherwise noted)

| Characteristic   | Symbol        | Min | Typ | Max  | Unit       |
|--|---------------|-----|-----|------|------------|
| <b>OFF CHARACTERISTICS</b>   |               |     |     |      |            |
| Collector-Base Cutoff Current<br>( $V_{CB} = 50\text{ V}, I_E = 0$ )                               | $I_{CBO}$     | -   | -   | 100  | nAdc       |
| Collector-Emitter Cutoff Current<br>( $V_{CE} = 50\text{ V}, I_B = 0$ )                            | $I_{CEO}$     | -   | -   | 500  | nAdc       |
| Emitter-Base Cutoff Current<br>( $V_{EB} = 6.0\text{ V}, I_C = 0$ )                                | $I_{EBO}$     | -   | -   | 2.3  | mAdc       |
| Collector-Base Breakdown Voltage<br>( $I_C = 10\ \mu\text{A}, I_E = 0$ )                           | $V_{(BR)CBO}$ | 50  | -   | -    | Vdc        |
| Collector-Emitter Breakdown Voltage (Note 5)<br>( $I_C = 2.0\text{ mA}, I_B = 0$ )                 | $V_{(BR)CEO}$ | 50  | -   | -    | Vdc        |
| <b>ON CHARACTERISTICS</b>  |               |     |     |      |            |
| DC Current Gain (Note 5)<br>( $I_C = 5.0\text{ mA}, V_{CE} = 10\text{ V}$ )                        | $h_{FE}$      | 8.0 | 15  | -    |            |
| Collector-Emitter Saturation Voltage (Note 5)<br>( $I_C = 10\text{ mA}, I_B = 5.0\text{ mA}$ )     | $V_{CE(sat)}$ | -   | -   | 0.25 | Vdc        |
| Input Voltage (off)<br>( $V_{CE} = 5.0\text{ V}, I_C = 100\ \mu\text{A}$ )                         | $V_{i(off)}$  | -   | 1.2 | 0.5  | Vdc        |
| Input Voltage (on)<br>( $V_{CE} = 0.3\text{ V}, I_C = 20\text{ mA}$ )                              | $V_{i(on)}$   | 2.0 | 1.7 | -    | Vdc        |
| Output Voltage (on)<br>( $V_{CC} = 5.0\text{ V}, V_B = 2.5\text{ V}, R_L = 1.0\text{ k}\Omega$ )   | $V_{OL}$      | -   | -   | 0.2  | Vdc        |
| Output Voltage (off)<br>( $V_{CC} = 5.0\text{ V}, V_B = 0.25\text{ V}, R_L = 1.0\text{ k}\Omega$ ) | $V_{OH}$      | 4.9 | -   | -    | Vdc        |
| Input Resistor   | R1            | 1.5 | 2.2 | 2.9  | k $\Omega$ |
| Resistor Ratio   | $R_1/R_2$     | 0.8 | 1.0 | 1.2  |            |

- Pulsed Condition: Pulse Width = 300 msec, Duty Cycle  $\leq$  2%.

TYPICAL CHARACTERISTICS  
MUN2131, MMUN2131L, MUN5131, DTA123EE, DTA123EM3

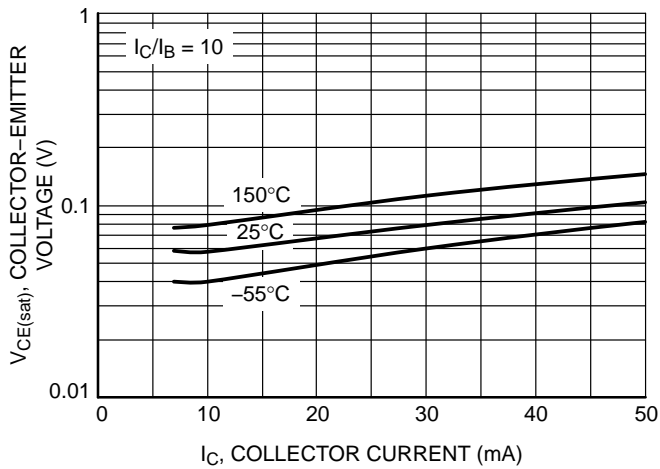

Figure 2.  $V_{CE(sat)}$  vs.  $I_C$

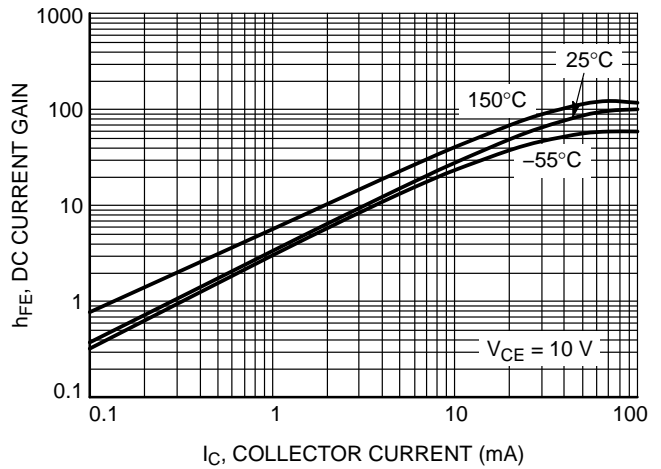

Figure 3. DC Current Gain

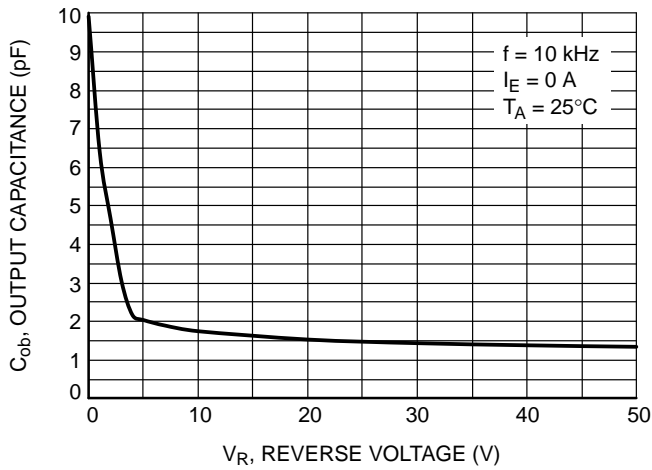

Figure 4. Output Capacitance

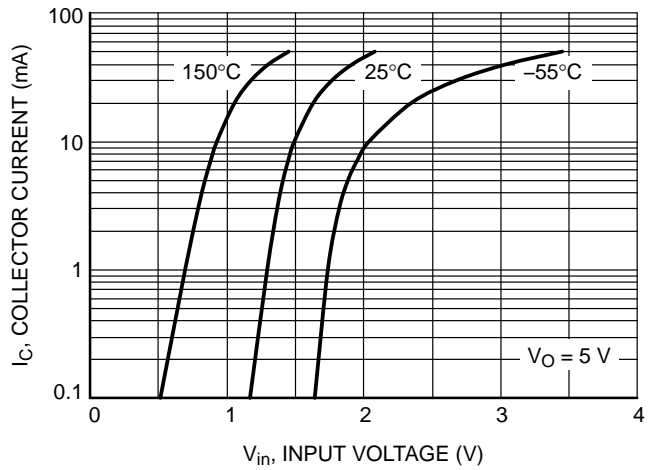

Figure 5. Output Current vs. Input Voltage

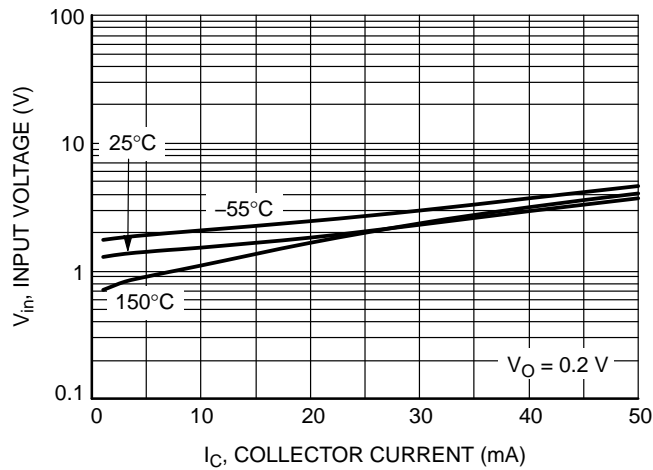
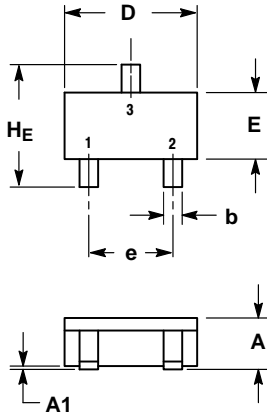

Figure 6. Input Voltage vs. Output Current

PACKAGE DIMENSIONS

SC-59  
CASE 318D-04  
ISSUE H



- NOTES:  
1. DIMENSIONING AND TOLERANCING PER ANSI Y14.5M, 1982.  
2. CONTROLLING DIMENSION: MILLIMETER.

| DIM | MILLIMETERS |      |      | INCHES |       |       |
|-----|-------------|------|------|--------|-------|-------|
|     | MIN         | NOM  | MAX  | MIN    | NOM   | MAX   |
| A   | 1.00        | 1.15 | 1.30 | 0.039  | 0.045 | 0.051 |
| A1  | 0.01        | 0.06 | 0.10 | 0.001  | 0.002 | 0.004 |
| b   | 0.35        | 0.43 | 0.50 | 0.014  | 0.017 | 0.020 |
| c   | 0.09        | 0.14 | 0.18 | 0.003  | 0.005 | 0.007 |
| D   | 2.70        | 2.90 | 3.10 | 0.106  | 0.114 | 0.122 |
| E   | 1.30        | 1.50 | 1.70 | 0.051  | 0.059 | 0.067 |
| e   | 1.70        | 1.90 | 2.10 | 0.067  | 0.075 | 0.083 |
| L   | 0.20        | 0.40 | 0.60 | 0.008  | 0.016 | 0.024 |
| HE  | 2.50        | 2.80 | 3.00 | 0.099  | 0.110 | 0.118 |

- STYLE 1:  
PIN 1. BASE  
2. EMITTER  
3. COLLECTOR

SOLDERING FOOTPRINT\*

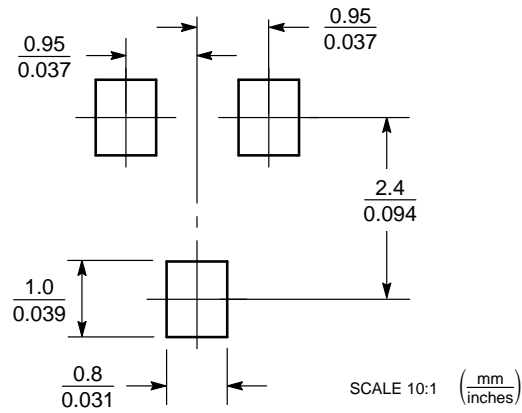

\*For additional information on our Pb-Free strategy and soldering details, please download the ON Semiconductor Soldering and Mounting Techniques Reference Manual, SOLDERRM/D.

PACKAGE DIMENSIONS

SOT-23 (TO-236)  
CASE 318-08  
ISSUE AP

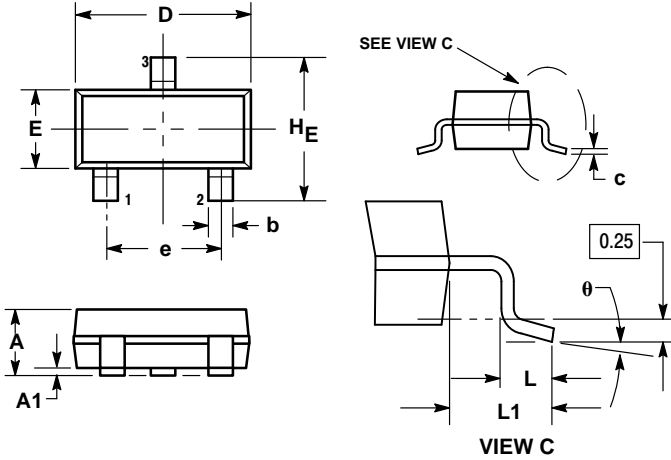

NOTES:

1. DIMENSIONING AND TOLERANCING PER ANSI Y14.5M, 1982.
2. CONTROLLING DIMENSION: INCH.
3. MAXIMUM LEAD THICKNESS INCLUDES LEAD FINISH THICKNESS. MINIMUM LEAD THICKNESS IS THE MINIMUM THICKNESS OF BASE MATERIAL.
4. DIMENSIONS D AND E DO NOT INCLUDE MOLD FLASH, PROTRUSIONS, OR GATE BURRS.

| DIM      | MILLIMETERS |      |      | INCHES |       |       |
|----------|-------------|------|------|--------|-------|-------|
|          | MIN         | NOM  | MAX  | MIN    | NOM   | MAX   |
| A        | 0.89        | 1.00 | 1.11 | 0.035  | 0.040 | 0.044 |
| A1       | 0.01        | 0.06 | 0.10 | 0.001  | 0.002 | 0.004 |
| b        | 0.37        | 0.44 | 0.50 | 0.015  | 0.018 | 0.020 |
| c        | 0.09        | 0.13 | 0.18 | 0.003  | 0.005 | 0.007 |
| D        | 2.80        | 2.90 | 3.04 | 0.110  | 0.114 | 0.120 |
| E        | 1.20        | 1.30 | 1.40 | 0.047  | 0.051 | 0.055 |
| e        | 1.78        | 1.90 | 2.04 | 0.070  | 0.075 | 0.081 |
| L        | 0.10        | 0.20 | 0.30 | 0.004  | 0.008 | 0.012 |
| L1       | 0.35        | 0.54 | 0.69 | 0.014  | 0.021 | 0.029 |
| HE       | 2.10        | 2.40 | 2.64 | 0.083  | 0.094 | 0.104 |
| $\theta$ | 0°          | ---  | 10°  | 0°     | ---   | 10°   |

STYLE 6:  
PIN 1. BASE  
2. EMITTER  
3. COLLECTOR

SOLDERING FOOTPRINT

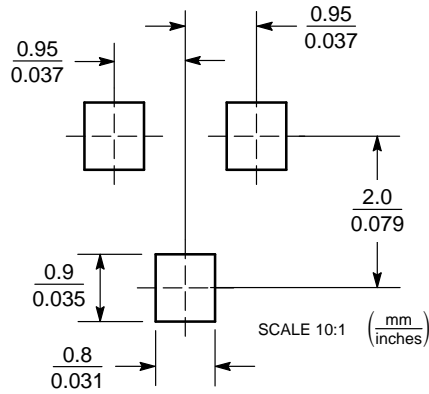

PACKAGE DIMENSIONS

SC-70 (SOT-323)  
CASE 419-04  
ISSUE N

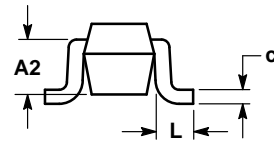
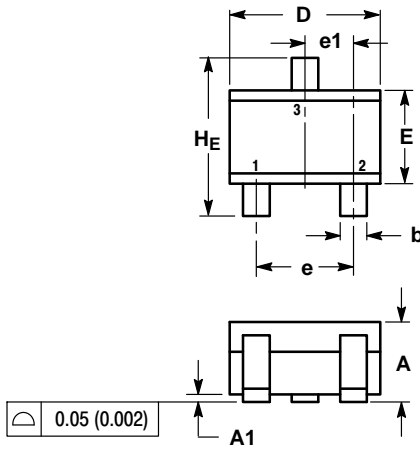

NOTES:

1. DIMENSIONING AND TOLERANCING PER ANSI Y14.5M, 1982.
2. CONTROLLING DIMENSION: INCH.

| DIM | MILLIMETERS |      |      | INCHES    |       |       |
|-----|-------------|------|------|-----------|-------|-------|
|     | MIN         | NOM  | MAX  | MIN       | NOM   | MAX   |
| A   | 0.80        | 0.90 | 1.00 | 0.032     | 0.035 | 0.040 |
| A1  | 0.00        | 0.05 | 0.10 | 0.000     | 0.002 | 0.004 |
| A2  | 0.70 REF    |      |      | 0.028 REF |       |       |
| b   | 0.30        | 0.35 | 0.40 | 0.012     | 0.014 | 0.016 |
| c   | 0.10        | 0.18 | 0.25 | 0.004     | 0.007 | 0.010 |
| D   | 1.80        | 2.10 | 2.20 | 0.071     | 0.083 | 0.087 |
| E   | 1.15        | 1.24 | 1.35 | 0.045     | 0.049 | 0.053 |
| e   | 1.20        | 1.30 | 1.40 | 0.047     | 0.051 | 0.055 |
| e1  | 0.65 BSC    |      |      | 0.026 BSC |       |       |
| L   | 0.20        | 0.38 | 0.56 | 0.008     | 0.015 | 0.022 |
| HE  | 2.00        | 2.10 | 2.40 | 0.079     | 0.083 | 0.095 |

STYLE 3:  
PIN 1. BASE  
2. EMITTER  
3. COLLECTOR

SOLDERING FOOTPRINT\*

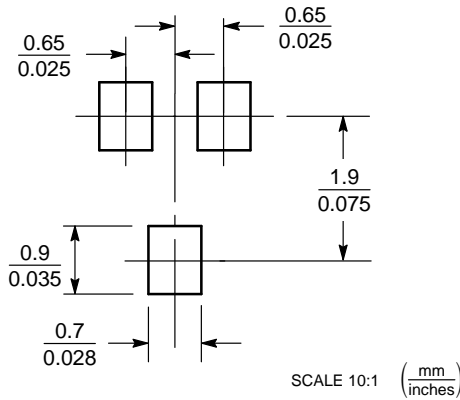

\*For additional information on our Pb-Free strategy and soldering details, please download the ON Semiconductor Soldering and Mounting Techniques Reference Manual, SOLDERRM/D.



PACKAGE DIMENSIONS

SC-75/SOT-416  
CASE 463  
ISSUE F

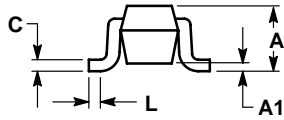
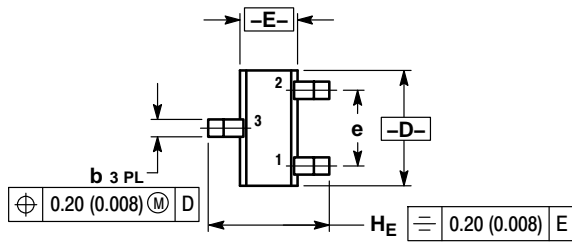

- NOTES:  
1. DIMENSIONING AND TOLERANCING PER ANSI Y14.5M, 1982.  
2. CONTROLLING DIMENSION: MILLIMETER.

| DIM            | MILLIMETERS |      |      | INCHES   |       |       |
|----------------|-------------|------|------|----------|-------|-------|
|                | MIN         | NOM  | MAX  | MIN      | NOM   | MAX   |
| A              | 0.70        | 0.80 | 0.90 | 0.027    | 0.031 | 0.035 |
| A1             | 0.00        | 0.05 | 0.10 | 0.000    | 0.002 | 0.004 |
| b              | 0.15        | 0.20 | 0.30 | 0.006    | 0.008 | 0.012 |
| C              | 0.10        | 0.15 | 0.25 | 0.004    | 0.006 | 0.010 |
| D              | 1.55        | 1.60 | 1.65 | 0.059    | 0.063 | 0.067 |
| E              | 0.70        | 0.80 | 0.90 | 0.027    | 0.031 | 0.035 |
| e              | 1.00 BSC    |      |      | 0.04 BSC |       |       |
| L              | 0.10        | 0.15 | 0.20 | 0.004    | 0.006 | 0.008 |
| H <sub>E</sub> | 1.50        | 1.60 | 1.70 | 0.061    | 0.063 | 0.065 |

- STYLE 1:  
PIN 1. BASE  
2. EMITTER  
3. COLLECTOR

SOLDERING FOOTPRINT\*

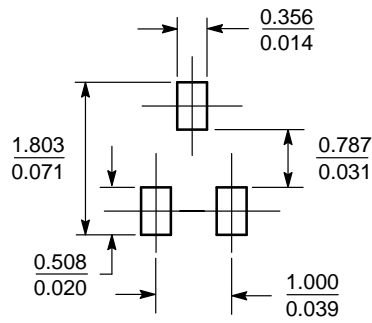

SCALE 10:1 (mm/inches)

\*For additional information on our Pb-Free strategy and soldering details, please download the ON Semiconductor Soldering and Mounting Techniques Reference Manual, SOLDERRM/D.

PACKAGE DIMENSIONS

SOT-723  
CASE 631AA  
ISSUE D

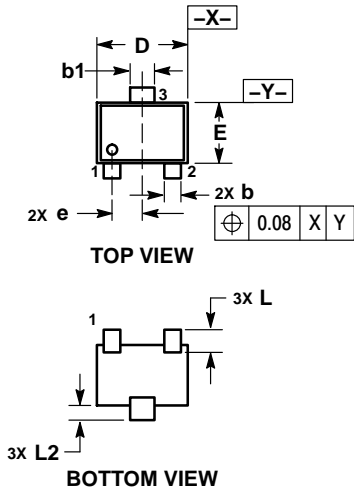

NOTES:

1. DIMENSIONING AND TOLERANCING PER ASME Y14.5M, 1994.
2. CONTROLLING DIMENSION: MILLIMETERS.
3. MAXIMUM LEAD THICKNESS INCLUDES LEAD FINISH. MINIMUM LEAD THICKNESS IS THE MINIMUM THICKNESS OF BASE MATERIAL.
4. DIMENSIONS D AND E DO NOT INCLUDE MOLD FLASH, PROTRUSIONS OR GATE BURRS.

| DIM            | MILLIMETERS |      |      |
|----------------|-------------|------|------|
|                | MIN         | NOM  | MAX  |
| A              | 0.45        | 0.50 | 0.55 |
| b              | 0.15        | 0.21 | 0.27 |
| b1             | 0.25        | 0.31 | 0.37 |
| C              | 0.07        | 0.12 | 0.17 |
| D              | 1.15        | 1.20 | 1.25 |
| E              | 0.75        | 0.80 | 0.85 |
| e              | 0.40 BSC    |      |      |
| H <sub>E</sub> | 1.15        | 1.20 | 1.25 |
| L              | 0.29 REF    |      |      |
| L2             | 0.15        | 0.20 | 0.25 |

STYLE 1:

1. BASE
2. EMITTER
3. COLLECTOR

RECOMMENDED  
SOLDERING FOOTPRINT\*

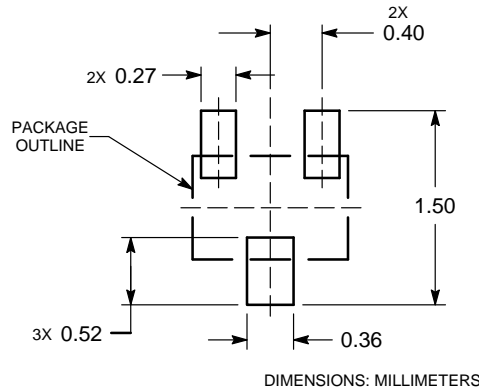

\*For additional information on our Pb-Free strategy and soldering details, please download the ON Semiconductor Soldering and Mounting Techniques Reference Manual, SOLDERRM/D.

PACKAGE DIMENSIONS

SOT-1123  
CASE 524AA  
ISSUE C

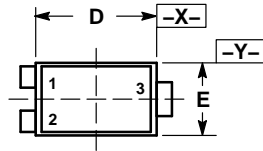

TOP VIEW

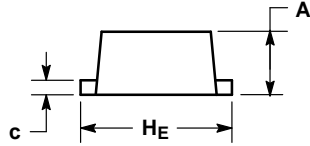

SIDE VIEW

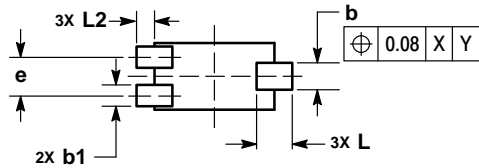

BOTTOM VIEW

NOTES:

1. DIMENSIONING AND TOLERANCING PER ASME Y14.5M, 1994.
2. CONTROLLING DIMENSION: MILLIMETERS.
3. MAXIMUM LEAD THICKNESS INCLUDES LEAD FINISH. MINIMUM LEAD THICKNESS IS THE MINIMUM THICKNESS OF BASE MATERIAL.
4. DIMENSIONS D AND E DO NOT INCLUDE MOLD FLASH, PROTRUSIONS, OR GATE BURRS.

| MILLIMETERS |       |      |
|-------------|-------|------|
| DIM         | MIN   | MAX  |
| A           | 0.34  | 0.40 |
| b           | 0.15  | 0.28 |
| b1          | 0.10  | 0.20 |
| c           | 0.07  | 0.17 |
| D           | 0.75  | 0.85 |
| E           | 0.55  | 0.65 |
| e           | 0.35  | 0.40 |
| HE          | 0.95  | 1.05 |
| L           | 0.185 | REF  |
| L2          | 0.05  | 0.15 |

STYLE 1:

1. BASE
2. EMITTER
3. COLLECTOR

SOLDERING FOOTPRINT\*

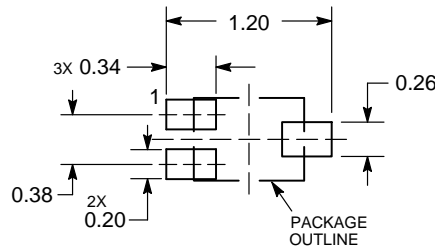

DIMENSIONS: MILLIMETERS

\*For additional information on our Pb-Free strategy and soldering details, please download the ON Semiconductor Soldering and Mounting Techniques Reference Manual, SOLDERRM/D.

ON Semiconductor and are registered trademarks of Semiconductor Components Industries, LLC (SCILLC). SCILLC owns the rights to a number of patents, trademarks, copyrights, trade secrets, and other intellectual property. A listing of SCILLC's product/patent coverage may be accessed at [www.onsemi.com/site/pdf/Patent-Marking.pdf](http://www.onsemi.com/site/pdf/Patent-Marking.pdf). SCILLC reserves the right to make changes without further notice to any products herein. SCILLC makes no warranty, representation or guarantee regarding the suitability of its products for any particular purpose, nor does SCILLC assume any liability arising out of the application or use of any product or circuit, and specifically disclaims any and all liability, including without limitation special, consequential or incidental damages. "Typical" parameters which may be provided in SCILLC data sheets and/or specifications can and do vary in different applications and actual performance may vary over time. All operating parameters, including "Typicals" must be validated for each customer application by customer's technical experts. SCILLC does not convey any license under its patent rights nor the rights of others. SCILLC products are not designed, intended, or authorized for use as components in systems intended for surgical implant into the body, or other applications intended to support or sustain life, or for any other application in which the failure of the SCILLC product could create a situation where personal injury or death may occur. Should Buyer purchase or use SCILLC products for any such unintended or unauthorized application, Buyer shall indemnify and hold SCILLC and its officers, employees, subsidiaries, affiliates, and distributors harmless against all claims, costs, damages, and expenses, and reasonable attorney fees arising out of, directly or indirectly, any claim of personal injury or death associated with such unintended or unauthorized use, even if such claim alleges that SCILLC was negligent regarding the design or manufacture of the part. SCILLC is an Equal Opportunity/Affirmative Action Employer. This literature is subject to all applicable copyright laws and is not for resale in any manner.

PUBLICATION ORDERING INFORMATION

LITERATURE FULFILLMENT:  
Literature Distribution Center for ON Semiconductor  
P.O. Box 5163, Denver, Colorado 80217 USA  
Phone: 303-675-2175 or 800-344-3860 Toll Free USA/Canada  
Fax: 303-675-2176 or 800-344-3867 Toll Free USA/Canada  
Email: [orderlit@onsemi.com](mailto:orderlit@onsemi.com)

N. American Technical Support: 800-282-9855 Toll Free  
USA/Canada  
Europe, Middle East and Africa Technical Support:  
Phone: 421 33 790 2910  
Japan Customer Focus Center  
Phone: 81-3-5817-1050

ON Semiconductor Website: [www.onsemi.com](http://www.onsemi.com)  
Order Literature: <http://www.onsemi.com/orderlit>  
For additional information, please contact your local Sales Representative

# Mouser Electronics

Authorized Distributor

Click to View Pricing, Inventory, Delivery & Lifecycle Information:

[ON Semiconductor:](#)

[MUN5131T1G](#) [DTA123EM3T5G](#) [NSVMUN5131T1G](#) [NSBA123EF3T5G](#) [NSVMMUN2131LT1G](#)