



2SC5277A

RF Transistor 10V, 30mA, $f_T=8\text{GHz}$, NPN Single SMCP

ON Semiconductor[®]
<http://onsemi.com>

Features

- Low-noise : NF=0.9dB typ (f=1GHz)
: NF=1.4dB typ (f=1.5GHz)
- High gain : $|S_{21e}|^2=10\text{dB}$ typ (f=1.5GHz)
- High cut-off frequency : $f_T=8\text{GHz}$ typ
- Low-voltage, low-current operation ($V_{CE}=1\text{V}$, $I_C=1\text{mA}$)
: $f_T=3.5\text{GHz}$ typ
: $|S_{21e}|^2=5.5\text{dB}$ typ (f=1.5GHz)
- Ultrasmall-sized package permitting applied sets to be made small and slim

Specifications

Absolute Maximum Ratings at $T_a=25^\circ\text{C}$

Parameter	Symbol	Conditions	Ratings	Unit
Collector-to-Base Voltage	V_{CBO}		20	V
Collector-to-Emitter Voltage	V_{CEO}		10	V
Emitter-to-Base Voltage	V_{EBO}		1.5	V
Collector Current	I_C		30	mA
Collector Dissipation	P_C		100	mW
Junction Temperature	T_j		150	$^\circ\text{C}$
Storage Temperature	T_{stg}		-55 to +150	$^\circ\text{C}$

Stresses exceeding Maximum Ratings may damage the device. Maximum Ratings are stress ratings only. Functional operation above the Recommended Operating Conditions is not implied. Extended exposure to stresses above the Recommended Operating Conditions may affect device reliability.

Package Dimensions

unit : mm (typ)

7027A-002

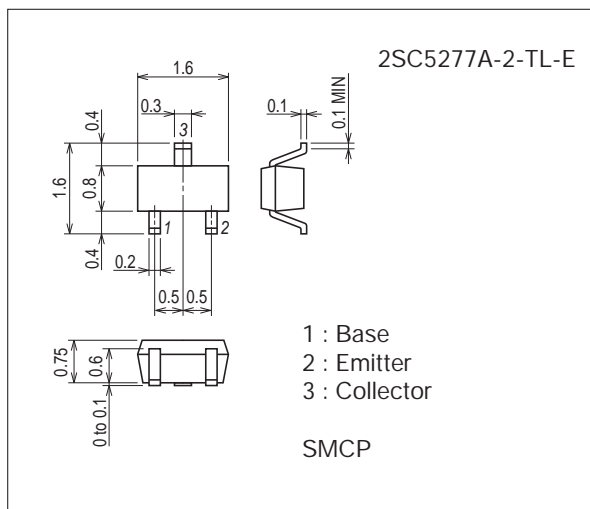

Product & Package Information

- Package : SMCP
- JEITA, JEDEC : SC-75, SOT-416
- Minimum Packing Quantity : 3,000 pcs./reel

Packing Type: TL

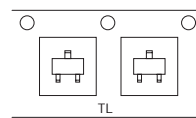

Marking

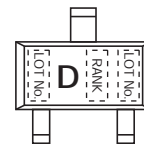

Electrical Connection

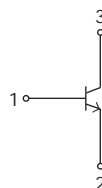

2SC5277A

Electrical Characteristics at Ta=25°C

Parameter	Symbol	Conditions	Ratings			Unit
			min	typ	max	
Collector Cutoff Current	ICBO	V _{CB} =10V, I _E =0A			1.0	μA
Emitter Cutoff Current	IEBO	V _{EB} =1V, I _C =0A			10	μA
DC Current Gain	h _{FE}	V _{CE} =5V, I _C =10mA	60*		270*	
Gain-Bandwidth Product	f _{T1}	V _{CE} =5V, I _C =10mA	5	8		GHz
	f _{T2}	V _{CE} =1V, I _C =1mA		3.5		GHz
Output Capacitance	C _{ob}	V _{CB} =10V, f=1MHz		0.45	0.7	pF
Reverse Transfer Capacitance	C _{re}				0.30	
Forward Transfer Gain	S _{21e} ² ₁	V _{CE} =5V, I _C =10mA, f=1.5GHz	8	10		dB
	S _{21e} ² ₂	V _{CE} =1V, I _C =1mA, f=1.5GHz		5.5		dB
Noise Figure	NF1	V _{CE} =5V, I _C =5mA, f=1.5GHz		1.4	3.0	dB
	NF2	V _{CE} =2V, I _C =3mA, f=1GHz		0.9		dB

* : The 2SC5277A is classified by 10mA h_{FE} as follows :

Rank	1	2	3
h _{FE}	60 to 120	90 to 180	135 to 270

Ordering Information

Device	Package	Shipping	memo
2SC5277A-2-TL-E	SMCP	3,000pcs./reel	Pb Free

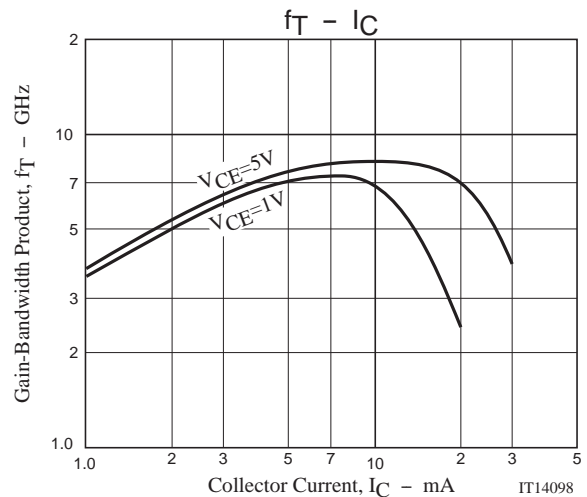
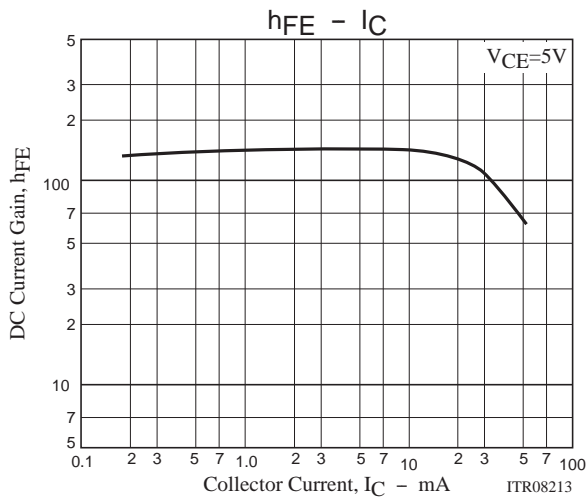

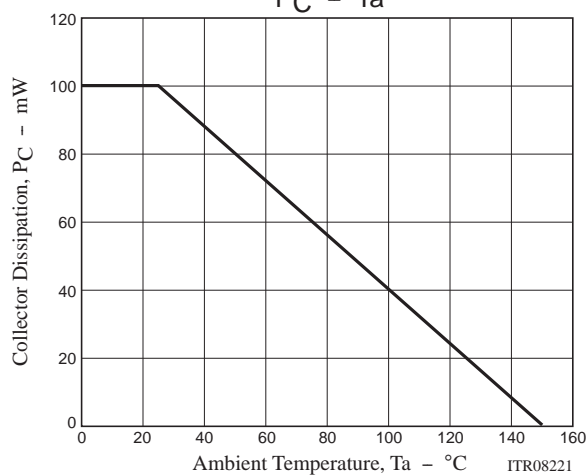
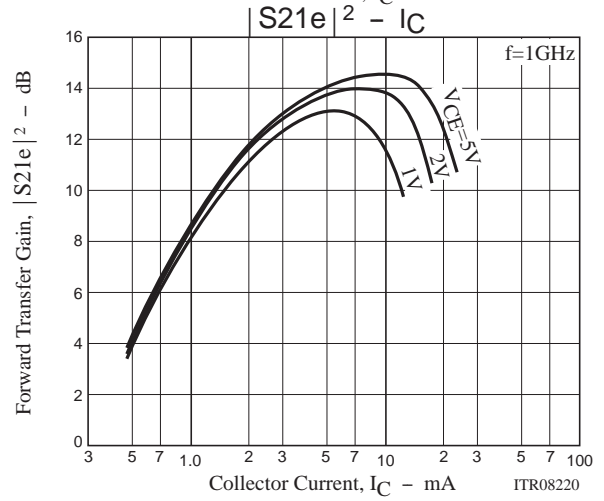
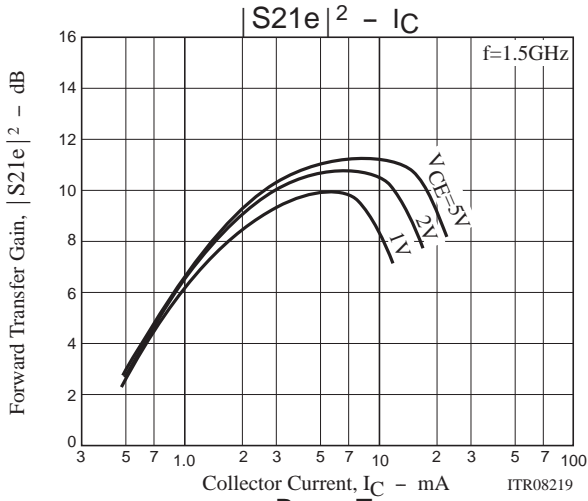
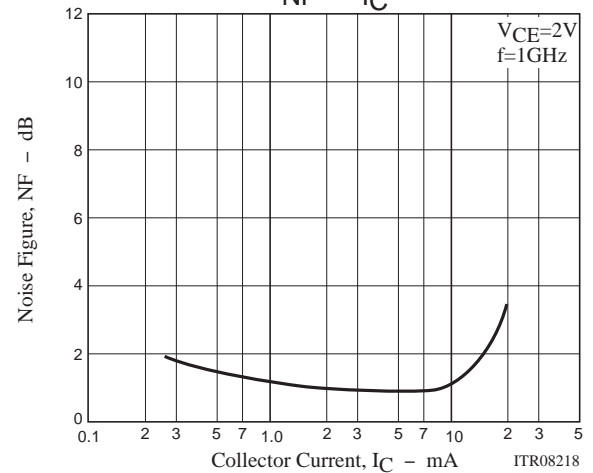
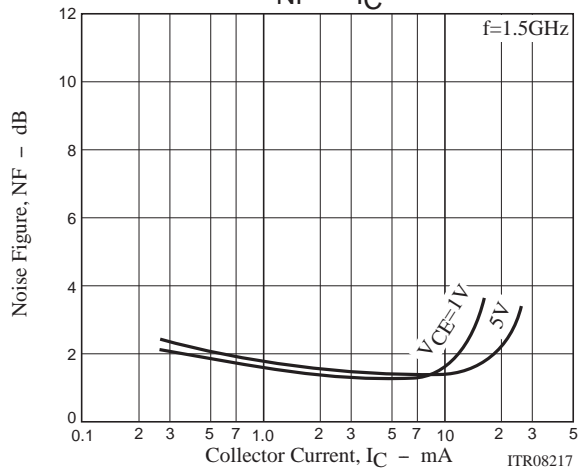
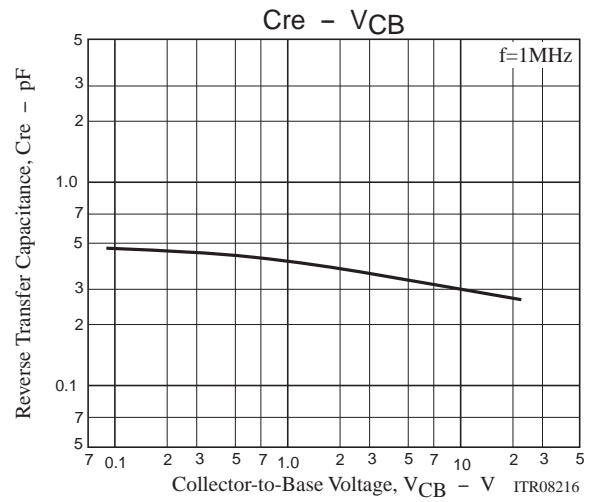
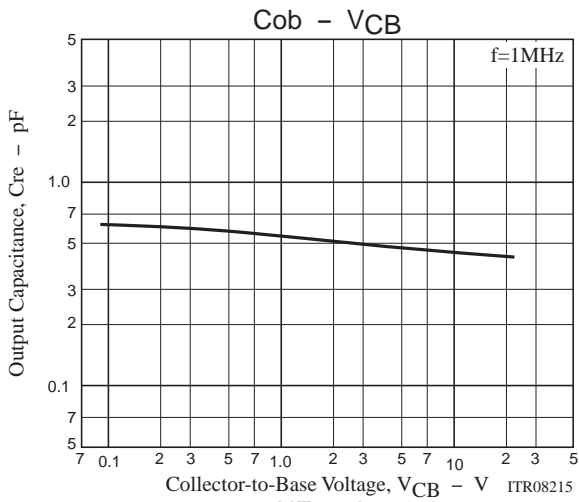

2SC5277A

S11e

f=200MHz to 2000MHz(200MHz Step)

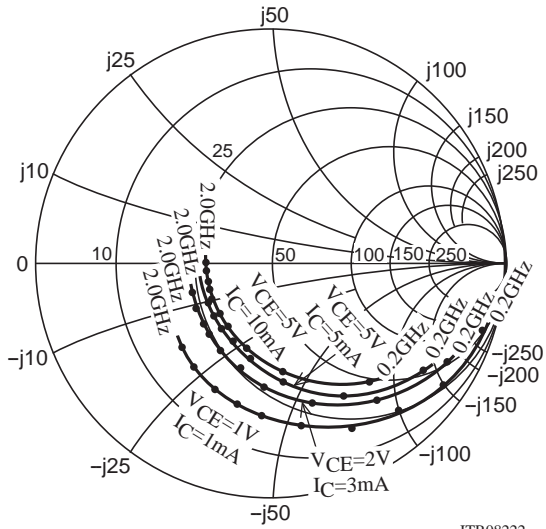

ITR08222

S21e

f=200MHz to 2000MHz(200MHz Step)

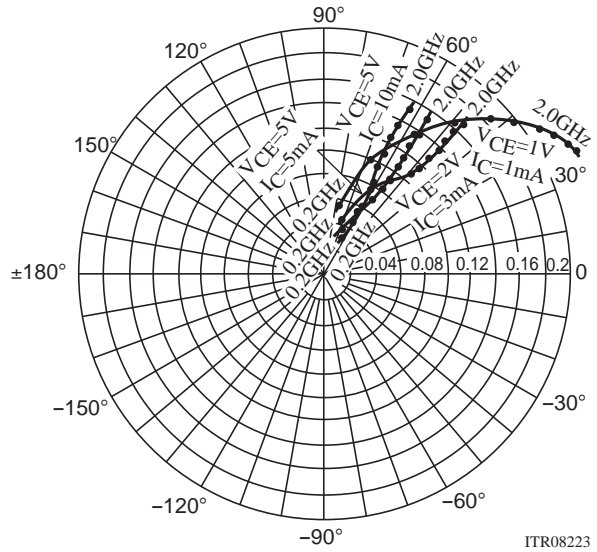

ITR08223

S12e

f=200MHz to 2000MHz(200MHz Step)

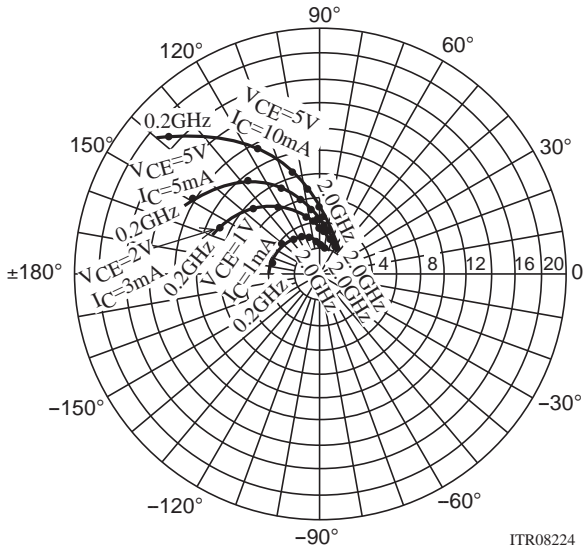

ITR08224

S22e

f=200MHz to 2000MHz(200MHz Step)

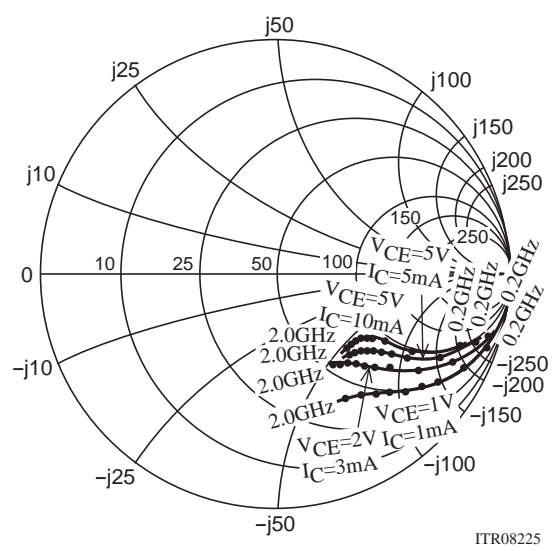

ITR08225

2SC5277A

S Parameters (Common emitter)

$V_{CE}=5V, I_C=5mA, Z_O=50\Omega$

Freq(MHz)	S11	$\angle S11$	S21	$\angle S21$	S12	$\angle S12$	S22	$\angle S22$
200	0.782	-37.1	12.043	148.4	0.038	69.7	0.889	-19.5
400	0.623	-65.4	9.431	126.6	0.057	60.8	0.758	-28.3
600	0.502	-85.6	7.415	112.2	0.072	56.5	0.646	-33.3
800	0.420	-102.4	6.000	101.5	0.083	55.2	0.577	-35.9
1000	0.369	-114.7	5.025	93.6	0.094	55.1	0.538	-37.6
1200	0.339	-127.2	4.323	86.7	0.105	55.6	0.513	-38.7
1400	0.311	-137.2	3.785	80.6	0.115	55.6	0.490	-39.7
1600	0.296	-144.9	3.391	75.3	0.127	56.7	0.480	-41.3
1800	0.285	-156.5	3.018	70.1	0.139	56.4	0.466	-43.5
2000	0.277	-164.2	2.767	65.7	0.150	56.7	0.460	-45.5

$V_{CE}=5V, I_C=10mA, Z_O=50\Omega$

Freq(MHz)	S11	$\angle S11$	S21	$\angle S21$	S12	$\angle S12$	S22	$\angle S22$
200	0.641	-52.7	16.527	137.8	0.031	67.4	0.820	-22.9
400	0.468	-85.4	11.299	115.7	0.048	60.5	0.643	-30.2
600	0.377	-106.6	8.303	103.1	0.060	60.0	0.549	-32.2
800	0.321	-124.1	6.502	94.0	0.072	60.9	0.499	-33.2
1000	0.293	-136.1	5.342	87.4	0.084	61.9	0.477	-33.9
1200	0.280	-146.7	4.546	81.4	0.097	62.7	0.462	-35.0
1400	0.266	-156.6	3.947	76.4	0.108	63.0	0.449	-36.2
1600	0.263	-163.2	3.527	71.4	0.123	63.7	0.444	-37.8
1800	0.263	173.5	3.121	67.0	0.136	62.8	0.435	-39.9
2000	0.264	179.8	2.864	62.8	0.150	62.4	0.434	-42.4

$V_{CE}=2V, I_C=3mA, Z_O=50\Omega$

Freq(MHz)	S11	$\angle S11$	S21	$\angle S21$	S12	$\angle S12$	S22	$\angle S22$
200	0.851	-30.4	8.644	154.1	0.042	73.0	0.937	-16.4
400	0.724	-55.7	7.310	133.8	0.073	61.3	0.820	-27.9
600	0.612	-76.1	6.083	118.6	0.093	54.2	0.709	-35.7
800	0.521	-93.0	5.085	106.9	0.107	50.4	0.628	-40.4
1000	0.461	-106.1	4.343	98.1	0.118	48.3	0.572	-43.7
1200	0.423	-118.6	3.806	90.0	0.128	47.5	0.536	-45.8
1400	0.382	-129.4	3.349	83.3	0.137	46.9	0.506	-47.3
1600	0.366	-138.0	3.036	77.5	0.147	47.4	0.485	-49.5
1800	0.341	-148.8	2.685	71.7	0.157	47.2	0.463	-51.9
2000	0.333	-157.7	2.479	66.7	0.167	47.6	0.453	-54.1

$V_{CE}=1V, I_C=1mA, Z_O=50\Omega$

Freq(MHz)	S11	$\angle S11$	S21	$\angle S21$	S12	$\angle S12$	S22	$\angle S22$
200	0.945	-18.7	3.431	162.9	0.053	78.1	0.982	-10.3
400	0.892	-36.9	3.263	147.1	0.099	66.9	0.939	-19.7
600	0.826	-52.9	3.004	133.2	0.136	57.5	0.879	-27.7
800	0.754	-67.9	2.765	120.4	0.164	49.7	0.815	-34.8
1000	0.691	-81.1	2.539	109.9	0.184	43.4	0.758	-40.0
1200	0.639	-94.3	2.366	99.8	0.199	38.4	0.727	-44.3
1400	0.589	-104.9	2.143	91.2	0.207	34.1	0.683	-47.8
1600	0.558	-114.1	1.969	83.6	0.213	31.7	0.653	-51.4
1800	0.522	-124.4	1.797	76.2	0.218	28.7	0.621	-54.9
2000	0.490	-134.9	1.701	69.7	0.219	27.0	0.601	-58.1

Embossed Taping Specification

2SC5277A-2-TL-E

1. Packing Format

Package Name	Carrier Tape Type	Maximum Number of devices contained (pcs)			Packing format	
		Reel	Inner box	Outer box	Inner BOX (C-1)	Outer BOX (A-7)
SMCP	SMCP	3,000	15,000	90,000	5 reels contained Dimensions:mm (external) 183×72×185	6 inner boxes contained Dimensions:mm (external) 440×195×210

Packing method

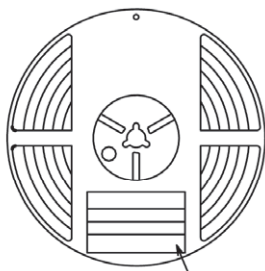

Reel label

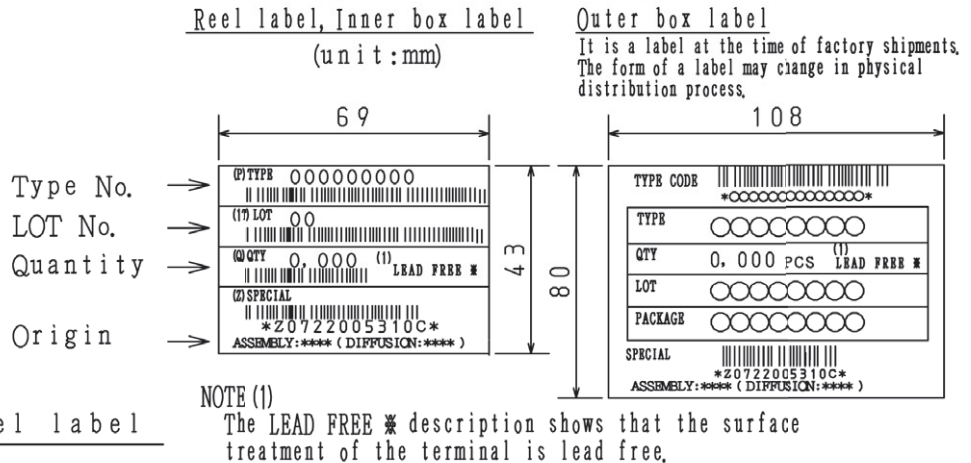

Label	JEITA Phase
.....	JEITA Phase 3

2. Taping configuration

2-1. Carrier tape size (unit:mm)

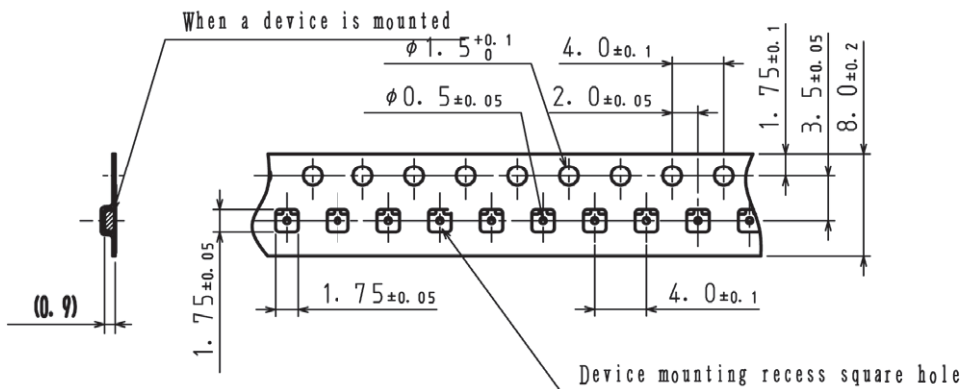

2-2. Device placement direction

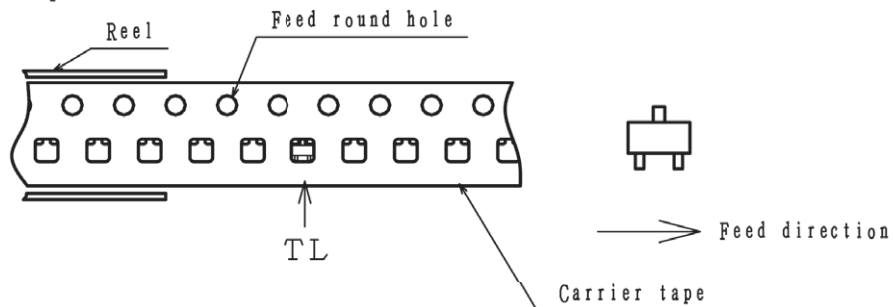

Those with one electrode terminal on the feed hole side.....TL

2SC5277A

Outline Drawing 2SC5277A-2-TL-E

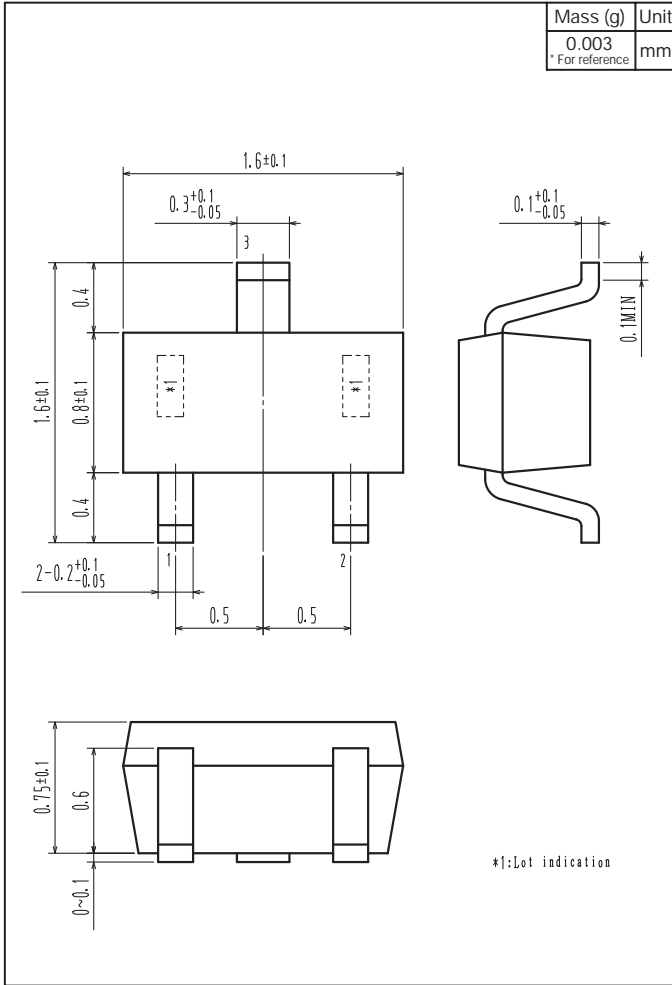

Land Pattern Example

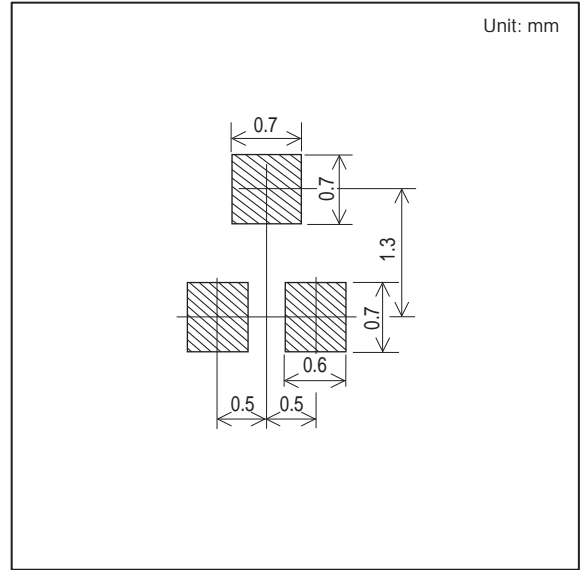

ON Semiconductor and the ON logo are registered trademarks of Semiconductor Components Industries, LLC (SCILLC). SCILLC owns the rights to a number of patents, trademarks, copyrights, trade secrets, and other intellectual property. A listing of SCILLC's product/patent coverage may be accessed at www.onsemi.com/site/pdf/Patent-Marking.pdf. SCILLC reserves the right to make changes without further notice to any products herein. SCILLC makes no warranty, representation or guarantee regarding the suitability of its products for any particular purpose, nor does SCILLC assume any liability arising out of the application or use of any product or circuit, and specifically disclaims any and all liability, including without limitation special, consequential or incidental damages. "Typical" parameters which may be provided in SCILLC data sheets and/or specifications can and do vary in different applications and actual performance may vary over time. All operating parameters, including "Typicals" must be validated for each customer application by customer's technical experts. SCILLC does not convey any license under its patent rights nor the rights of others. SCILLC products are not designed, intended, or authorized for use as components in systems intended for surgical implant into the body, or other applications intended to support or sustain life, or for any other application in which the failure of the SCILLC product could create a situation where personal injury or death may occur. Should Buyer purchase or use SCILLC products for any such unintended or unauthorized application, Buyer shall indemnify and hold SCILLC and its officers, employees, subsidiaries, affiliates, and distributors harmless against all claims, costs, damages, and expenses, and reasonable attorney fees arising out of, directly or indirectly, any claim of personal injury or death associated with such unintended or unauthorized use, even if such claim alleges that SCILLC was negligent regarding the design or manufacture of the part. SCILLC is an Equal Opportunity/Affirmative Action Employer. This literature is subject to all applicable copyright laws and is not for resale in any manner.

Mouser Electronics

Authorized Distributor

Click to View Pricing, Inventory, Delivery & Lifecycle Information:

[ON Semiconductor:](#)

[2SC5277A-2-TL-E](#)