

MBR140ESF, NRVB140ESF

Surface Mount Schottky Power Rectifier

Plastic SOD-123 Package

This device uses the Schottky Barrier principle with a large area metal-to-silicon power diode. Ideally suited for low voltage, high frequency rectification or as free wheeling and polarity protection diodes in surface mount applications where compact size and weight are critical to the system. This package also provides an easy to work with alternative to leadless 34 package style. Because of its small size, it is ideal for use in portable and battery powered products such as cellular and cordless phones, chargers, notebook computers, printers, PDAs and PCMCIA cards. Typical applications are AC-DC and DC-DC converters, reverse battery protection, and “Oring” of multiple supply voltages and any other application where performance and size are critical.

Features

- Guardring for Stress Protection
- Low Reverse Leakage
- 175°C Operating Junction Temperature
- Epoxy Meets UL 94 V-0 @ 0.125 in
- Package Designed for Optimal Automated Board Assembly
- ESD Rating:
 - ◆ Human Body Model = 3B
 - ◆ Machine Model = M4
- NRVB Prefix for Automotive and Other Applications Requiring Unique Site and Control Change Requirements; AEC-Q101 Qualified and PPAP Capable
- These Devices are Pb-Free and are RoHS Compliant*

Mechanical Characteristics

- Device Marking: E4F
- Polarity Designator: Cathode Band
- Weight: 11.7 mg (approximately)
- Case: Epoxy, Molded
- Finish: All External Surfaces Corrosion Resistant and Terminal Leads are Readily Solderable
- Lead and Mounting Surface Temperature for Soldering Purposes: 260°C Max. for 10 Seconds

*For additional information on our Pb-Free strategy and soldering details, please download the ON Semiconductor Soldering and Mounting Techniques Reference Manual, SOLDERRM/D.



ON Semiconductor®

<http://onsemi.com>

**SCHOTTKY BARRIER
RECTIFIER
1.0 AMPERES
40 VOLTS**

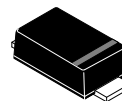

SOD-123FL
CASE 498

MARKING DIAGRAM

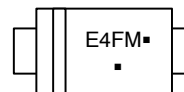

E4F = Specific Device Code
M = Date Code
▪ = Pb-Free Package)

(Note: Microdot may be in either location)

ORDERING INFORMATION

Device	Package	Shipping†
MBR140ESFT1G	SOD-123FL (Pb-Free)	3,000 / Tape & Reel **
MBR140ESFT3G	SOD-123FL (Pb-Free)	10,000 / Tape & Reel ***
NRVB140ESFT1G	SOD-123FL (Pb-Free)	3,000 / Tape & Reel **
NRVB140ESFT3G	SOD-123FL (Pb-Free)	10,000 / Tape & Reel ***

†For information on tape and reel specifications, including part orientation and tape sizes, please refer to our Tape and Reel Packaging Specifications Brochure, BRD8011/D.

** 8 mm Tape, 7" Reel

*** 8 mm Tape, 13" Reel

MBR140ESF, NRVB140ESF

MAXIMUM RATINGS

Rating	Symbol	Value	Unit
Peak Repetitive Reverse Voltage Working Peak Reverse Voltage DC Blocking Voltage	V_{RRM} V_{RWM} V_R	40	V
Average Rectified Forward Current	I_O	1.0	A
Peak Repetitive Forward Current	I_{FRM}	2.0	A
Non-Repetitive Peak Surge Current (Non-Repetitive peak surge current, halfwave, single phase, 60 Hz)	I_{FSM}	30	A
Storage Temperature	T_{stg}	-55 to 175	°C
Operating Junction Temperature	T_J	-55 to 175	°C

Stresses exceeding those listed in the Maximum Ratings table may damage the device. If any of these limits are exceeded, device functionality should not be assumed, damage may occur and reliability may be affected.

THERMAL CHARACTERISTICS

Characteristic	Symbol	Value	Unit
Thermal Resistance, Junction-to-Lead (Note 1)	R_{tjl}	26	°C/W
Thermal Resistance, Junction-to-Lead (Note 2)	R_{tjl}	21	°C/W
Thermal Resistance, Junction-to-Ambient (Note 1)	R_{tja}	325	°C/W
Thermal Resistance, Junction-to-Ambient (Note 2)	R_{tja}	82	°C/W

1. Mounted with minimum recommended pad size, PC Board FR4.
2. Mounted with 1 in. copper pad (Cu area 700 mm²).

ELECTRICAL CHARACTERISTICS

Characteristic	Symbol	Value	Unit
Maximum Instantaneous Forward Voltage (Note 3) ($I_F = 1.0$ A)	V_F	$T_J = 25^\circ\text{C}$ 0.56	V
Maximum Instantaneous Reverse Current (Note 3) ($V_R = 40$ V)	I_R	$T_J = 25^\circ\text{C}$ 30	μA

3. Pulse Test: Pulse Width ≤ 250 μs, Duty Cycle ≤ 2%.

MBR140ESF, NRVB140ESF

TYPICAL CHARACTERISTICS

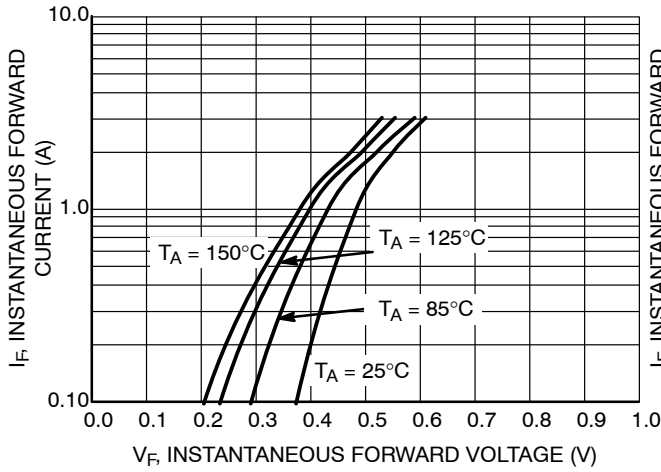

Figure 1. Typical Instantaneous Forward Characteristics

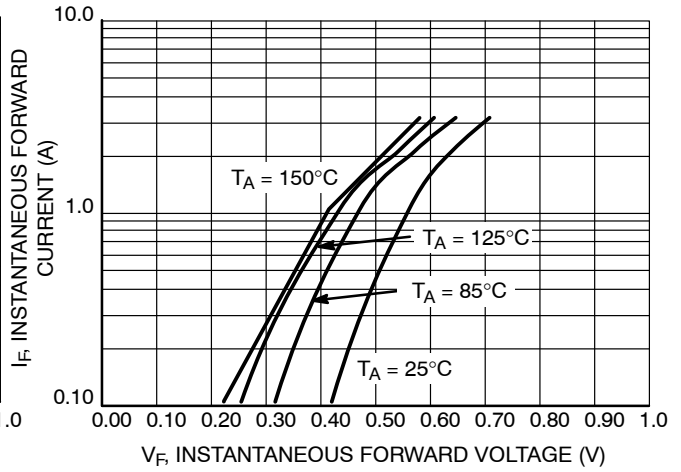

Figure 2. Maximum Instantaneous Forward Characteristics

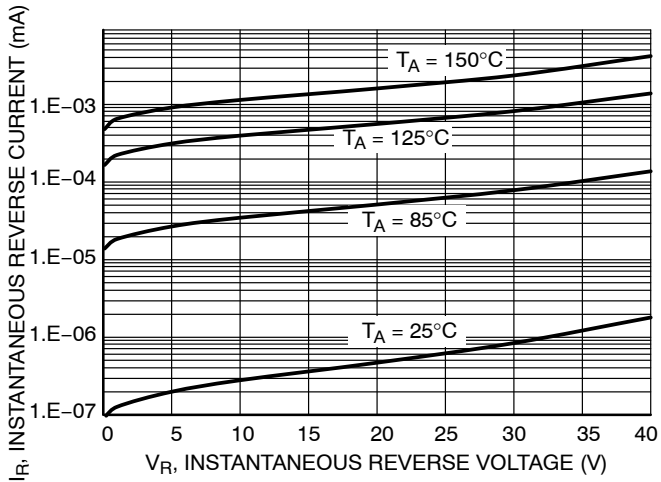

Figure 3. Typical Reverse Characteristics

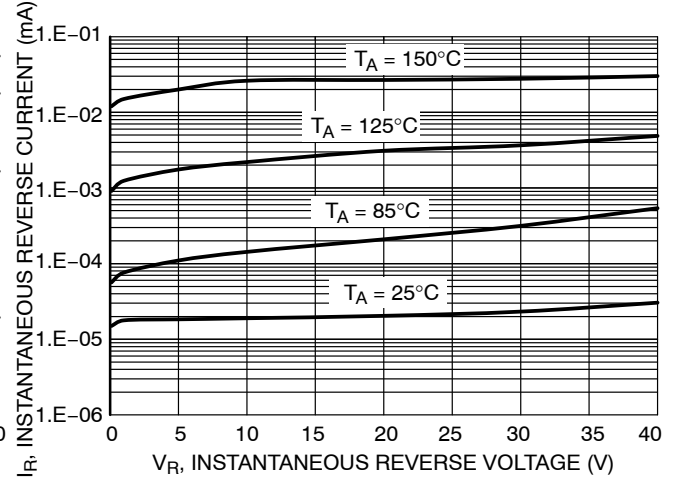

Figure 4. Maximum Reverse Characteristics

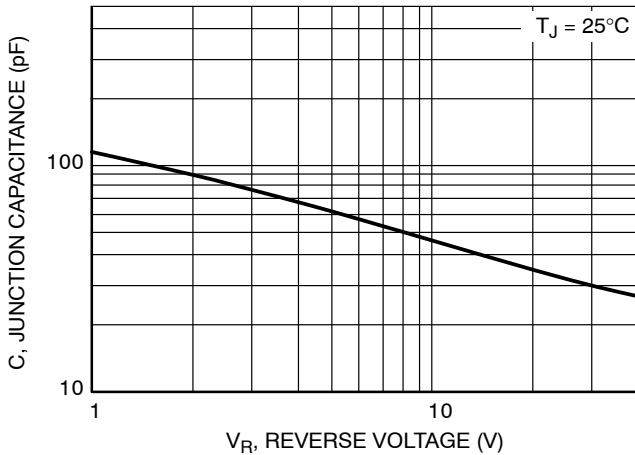

Figure 5. Typical Junction Capacitance

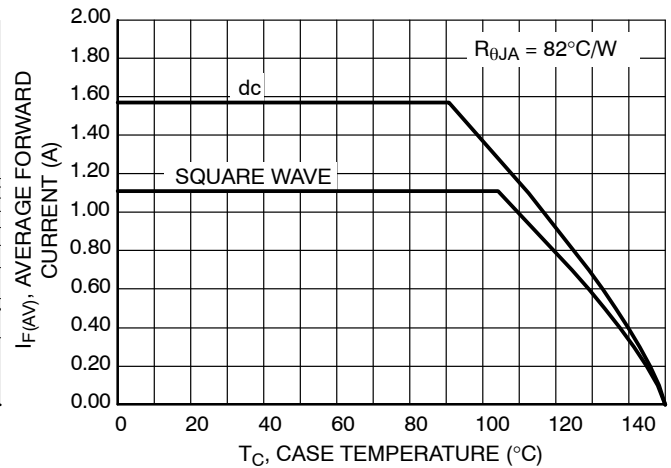

Figure 6. Current Derating, Case

MBR140ESF, NRVB140ESF

TYPICAL CHARACTERISTICS

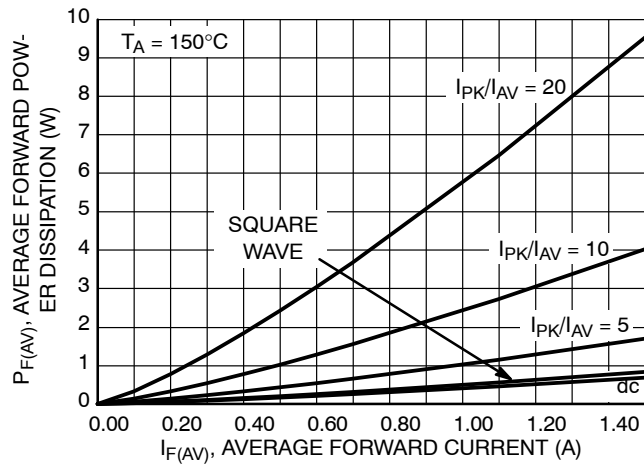

Figure 7. Forward Power Dissipation

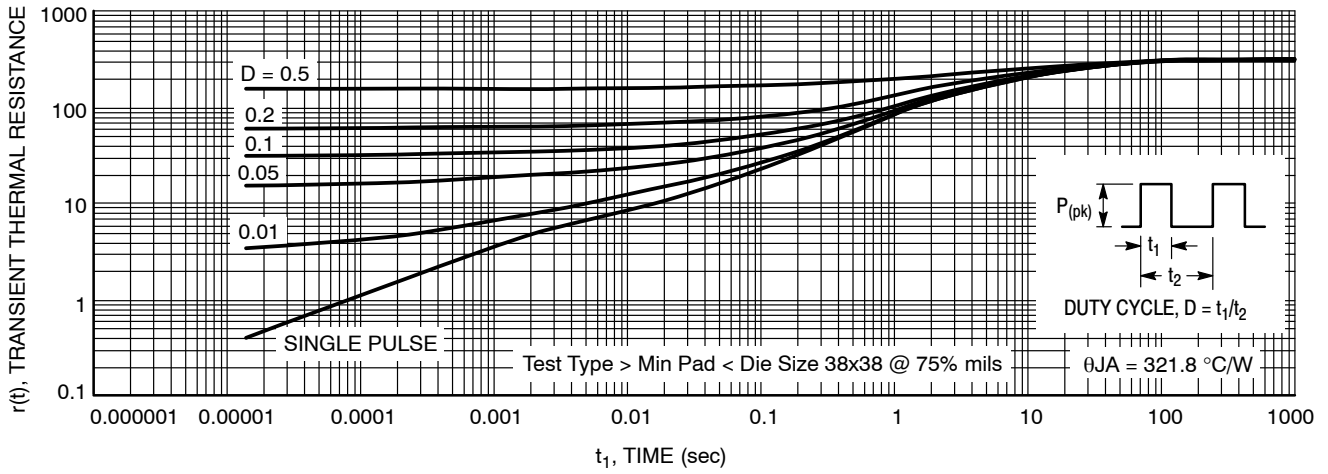
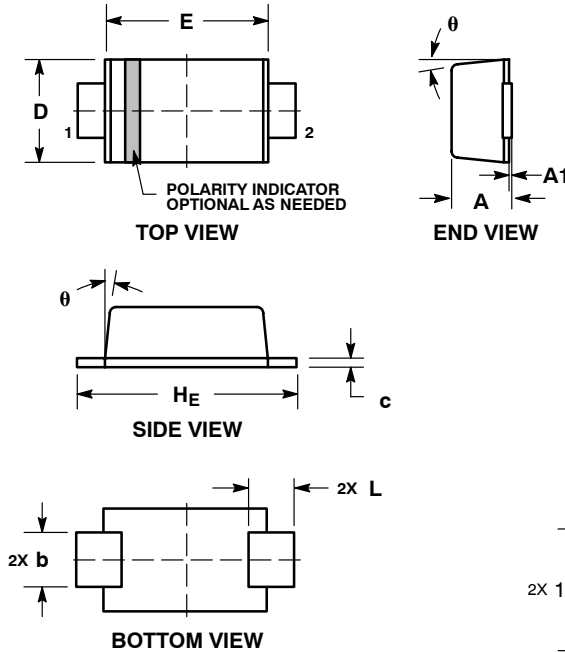

Figure 8. Thermal Response

MBR140ESF, NRVB140ESF

PACKAGE DIMENSIONS

SOD-123FL
CASE 498
ISSUE D



NOTES:

1. DIMENSIONING AND TOLERANCING PER ANSI Y14.5M, 1982.
2. CONTROLLING DIMENSION: MILLIMETER.
3. DIMENSIONS A AND B DO NOT INCLUDE MOLD FLASH.
4. DIMENSIONS D AND J ARE TO BE MEASURED ON FLAT SECTION OF THE LEAD: BETWEEN 0.10 AND 0.25 MM FROM THE LEAD TIP.

DIM	MILLIMETERS			INCHES		
	MIN	NOM	MAX	MIN	NOM	MAX
A	0.90	0.95	0.98	0.035	0.037	0.039
A1	0.00	0.05	0.10	0.000	0.002	0.004
b	0.70	0.90	1.10	0.028	0.035	0.043
c	0.10	0.15	0.20	0.004	0.006	0.008
D	1.50	1.65	1.80	0.059	0.065	0.071
E	2.50	2.70	2.90	0.098	0.106	0.114
L	0.55	0.75	0.95	0.022	0.030	0.037
H _E	3.40	3.60	3.80	0.134	0.142	0.150
θ	0°	-	8°	0°	-	8°

RECOMMENDED SOLDERING FOOTPRINT*

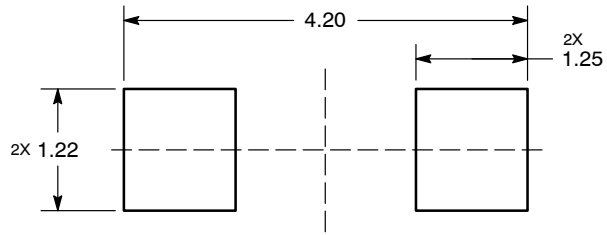

DIMENSIONS: MILLIMETERS

*For additional information on our Pb-Free strategy and soldering details, please download the ON Semiconductor Soldering and Mounting Techniques Reference Manual, SOLDERRM/D.

ON Semiconductor and are registered trademarks of Semiconductor Components Industries, LLC (SCILLC). SCILLC owns the rights to a number of patents, trademarks, copyrights, trade secrets, and other intellectual property. A listing of SCILLC's product/patent coverage may be accessed at www.onsemi.com/site/pdf/Patent-Marking.pdf. SCILLC reserves the right to make changes without further notice to any products herein. SCILLC makes no warranty, representation or guarantee regarding the suitability of its products for any particular purpose, nor does SCILLC assume any liability arising out of the application or use of any product or circuit, and specifically disclaims any and all liability, including without limitation special, consequential or incidental damages. "Typical" parameters which may be provided in SCILLC data sheets and/or specifications can and do vary in different applications and actual performance may vary over time. All operating parameters, including "Typicals" must be validated for each customer application by customer's technical experts. SCILLC does not convey any license under its patent rights nor the rights of others. SCILLC products are not designed, intended, or authorized for use as components in systems intended for surgical implant into the body, or other applications intended to support or sustain life, or for any other application in which the failure of the SCILLC product could create a situation where personal injury or death may occur. Should Buyer purchase or use SCILLC products for any such unintended or unauthorized application, Buyer shall indemnify and hold SCILLC and its officers, employees, subsidiaries, affiliates, and distributors harmless against all claims, costs, damages, and expenses, and reasonable attorney fees arising out of, directly or indirectly, any claim of personal injury or death associated with such unintended or unauthorized use, even if such claim alleges that SCILLC was negligent regarding the design or manufacture of the part. SCILLC is an Equal Opportunity/Affirmative Action Employer. This literature is subject to all applicable copyright laws and is not for resale in any manner.

PUBLICATION ORDERING INFORMATION

LITERATURE FULFILLMENT:

Literature Distribution Center for ON Semiconductor
P.O. Box 5163, Denver, Colorado 80217 USA
Phone: 303-675-2175 or 800-344-3860 Toll Free USA/Canada
Fax: 303-675-2176 or 800-344-3867 Toll Free USA/Canada
Email: orderlit@onsemi.com

N. American Technical Support: 800-282-9855 Toll Free
USA/Canada
Europe, Middle East and Africa Technical Support:
Phone: 421 33 790 2910
Japan Customer Focus Center
Phone: 81-3-5817-1050

ON Semiconductor Website: www.onsemi.com
Order Literature: <http://www.onsemi.com/orderlit>

For additional information, please contact your local Sales Representative

Mouser Electronics

Authorized Distributor

Click to View Pricing, Inventory, Delivery & Lifecycle Information:

[ON Semiconductor:](#)

[MBR140ESFT1G](#) [MBR140ESFT3G](#) [NRVB140ESFT3G](#) [NRVB140ESFT1G](#)