

MBT2222ADW1, NSVBT2222ADW1

General Purpose Transistor

NPN Silicon

Features

- Moisture Sensitivity Level: 1
- NSV Prefix for Automotive and Other Applications Requiring Unique Site and Control Change Requirements; AEC-Q101 Qualified and PPAP Capable
- These Devices are Pb-Free, Halogen Free/BFR Free and are RoHS Compliant

MAXIMUM RATINGS

Rating	Symbol	Value	Unit
Collector-Emitter Voltage	V_{CEO}	40	Vdc
Collector-Base Voltage	V_{CBO}	75	Vdc
Emitter-Base Voltage	V_{EBO}	6.0	Vdc
Collector Current - Continuous	I_C	600	mAdc
Electrostatic Discharge	ESD	HBM Class 2 MM Class B	

THERMAL CHARACTERISTICS

Characteristic	Symbol	Max	Unit
Total Package Dissipation (Note 1), $T_A = 25^\circ\text{C}$	P_D	150	mW
Thermal Resistance, Junction-to-Ambient	$R_{\theta JA}$	833	$^\circ\text{C/W}$
Junction and Storage Temperature	T_J, T_{stg}	-55 to +150	$^\circ\text{C}$

Stresses exceeding Maximum Ratings may damage the device. Maximum Ratings are stress ratings only. Functional operation above the Recommended Operating Conditions is not implied. Extended exposure to stresses above the Recommended Operating Conditions may affect device reliability.

1. Device mounted on FR4 glass epoxy printed circuit board using the minimum recommended footprint.



ON Semiconductor®

<http://onsemi.com>

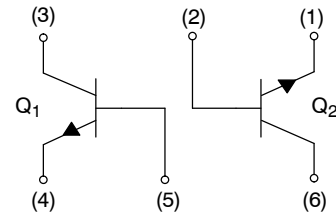

SC-88/SC70-6/SOT-363
CASE 419B
STYLE 1

MARKING DIAGRAM

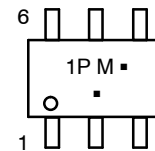

1P = Specific Device Code
M = Date Code
▪ = Pb-Free Package
(Note: Microdot may be in either location)

ORDERING INFORMATION

Device	Package	Shipping†
MBT2222ADW1T1G	SOT-363 (Pb-Free)	3000 / Tape & Reel
NSVBT2222ADW1T1G	SOT-363 (Pb-Free)	3000 / Tape & Reel

†For information on tape and reel specifications, including part orientation and tape sizes, please refer to our Tape and Reel Packaging Specifications Brochure, BRD8011/D.

MBT2222ADW1, NSVB2222ADW1

ELECTRICAL CHARACTERISTICS (T_A = 25°C unless otherwise noted)

Characteristic	Symbol	Min	Max	Unit
OFF CHARACTERISTICS				
Collector–Emitter Breakdown Voltage (I _C = 10 mA _{dc} , I _B = 0)	V _{(BR)CEO}	40	–	V _{dc}
Collector–Base Breakdown Voltage (I _C = 10 μA _{dc} , I _E = 0)	V _{(BR)CBO}	75	–	V _{dc}
Emitter–Base Breakdown Voltage, (I _E = 10 μA _{dc} , I _C = 0)	V _{(BR)EBO}	6.0	–	V _{dc}
Collector Cutoff Current (V _{CE} = 60 V _{dc} , V _{EB(off)} = 3.0 V _{dc})	I _{CEX}	–	10	nA _{dc}
Collector Cutoff Current (V _{CB} = 60 V _{dc} , I _E = 0) (V _{CB} = 60 V _{dc} , I _E = 0, T _A = 125°C)	I _{CBO}	– –	0.01 10	μA _{dc}
Emitter Cutoff Current (V _{EB} = 3.0 V _{dc} , I _C = 0)	I _{EBO}	–	100	nA _{dc}
Base Cutoff Current (V _{CE} = 60 V _{dc} , V _{EB(off)} = 3.0 V _{dc})	I _{BL}	–	20	nA _{dc}

ON CHARACTERISTICS

DC Current Gain (I _C = 0.1 mA _{dc} , V _{CE} = 10 V _{dc}) (I _C = 1.0 mA _{dc} , V _{CE} = 10 V _{dc}) (I _C = 10 mA _{dc} , V _{CE} = 10 V _{dc}) (I _C = 10 mA _{dc} , V _{CE} = 10 V _{dc} , T _A = –55°C) (I _C = 150 mA _{dc} , V _{CE} = 10 V _{dc}) (Note 2) (I _C = 150 mA _{dc} , V _{CE} = 1.0 V _{dc}) (Note 2) (I _C = 500 mA _{dc} , V _{CE} = 10 V _{dc}) (Note 2)	h _{FE}	35 50 75 35 100 50 40	– – – – 300 – –	–
Collector–Emitter Saturation Voltage (Note 2) (I _C = 150 mA _{dc} , I _B = 15 mA _{dc}) (I _C = 500 mA _{dc} , I _B = 50 mA _{dc})	V _{CE(sat)}	– –	0.3 1.0	V _{dc}
Base–Emitter Saturation Voltage (Note 2) (I _C = 150 mA _{dc} , I _B = 15 mA _{dc}) (I _C = 500 mA _{dc} , I _B = 50 mA _{dc})	V _{BE(sat)}	0.6 –	1.2 2.0	V _{dc}

SMALL–SIGNAL CHARACTERISTICS

Current–Gain – Bandwidth Product (Note 3) (I _C = 20 mA _{dc} , V _{CE} = 20 V _{dc} , f = 100 MHz)	f _T	300	–	MHz
Output Capacitance (V _{CB} = 10 V _{dc} , I _E = 0, f = 1.0 MHz)	C _{obo}	–	8.0	pF
Input Capacitance (V _{EB} = 0.5 V _{dc} , I _C = 0, f = 1.0 MHz)	C _{ibo}	–	25	pF
Input Impedance (I _C = 1.0 mA _{dc} , V _{CE} = 10 V _{dc} , f = 1.0 kHz) (I _C = 10 mA _{dc} , V _{CE} = 10 V _{dc} , f = 1.0 kHz)	h _{ie}	2.0 0.25	8.0 1.25	kΩ
Voltage Feedback Ratio (I _C = 1.0 mA _{dc} , V _{CE} = 10 V _{dc} , f = 1.0 kHz) (I _C = 10 mA _{dc} , V _{CE} = 10 V _{dc} , f = 1.0 kHz)	h _{re}	– –	8.0 4.0	X 10 ^{–4}
Small–Signal Current Gain (I _C = 1.0 mA _{dc} , V _{CE} = 10 V _{dc} , f = 1.0 kHz) (I _C = 10 mA _{dc} , V _{CE} = 10 V _{dc} , f = 1.0 kHz)	h _{fe}	50 75	300 375	–
Output Admittance (I _C = 1.0 mA _{dc} , V _{CE} = 10 V _{dc} , f = 1.0 kHz) (I _C = 10 mA _{dc} , V _{CE} = 10 V _{dc} , f = 1.0 kHz)	h _{oe}	5.0 25	35 200	μmhos
Collector Base Time Constant (I _E = 20 mA _{dc} , V _{CB} = 20 V _{dc} , f = 31.8 MHz)	r _b , C _c	–	150	ps
Noise Figure (I _C = 100 μA _{dc} , V _{CE} = 10 V _{dc} , R _S = 1.0 kΩ, f = 1.0 kHz)	NF	–	4.0	dB

SWITCHING CHARACTERISTICS

Delay Time	(V _{CC} = 30 V _{dc} , V _{BE(off)} = –0.5 V _{dc} , I _C = 150 mA _{dc} , I _{B1} = 15 mA _{dc})	t _d	–	10	ns
Rise Time		t _r	–	25	
Storage Time	(V _{CC} = 30 V _{dc} , I _C = 150 mA _{dc} , I _{B1} = I _{B2} = 15 mA _{dc})	t _s	–	225	ns
Fall Time		t _f	–	60	

2. Pulse Test: Pulse Width ≤ 300 μs, Duty Cycle ≤ 2.0%.

3. f_T is defined as the frequency at which |h_{fe}| extrapolates to unity.

MBT2222ADW1, NSVBT2222ADW1

SWITCHING TIME EQUIVALENT TEST CIRCUITS

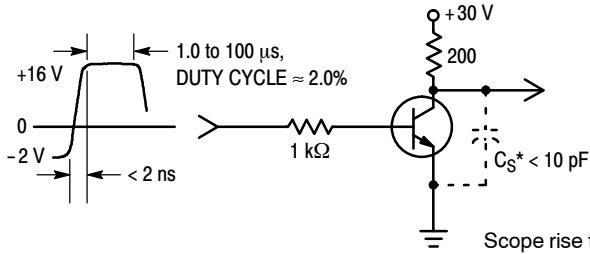

Figure 1. Turn-On Time

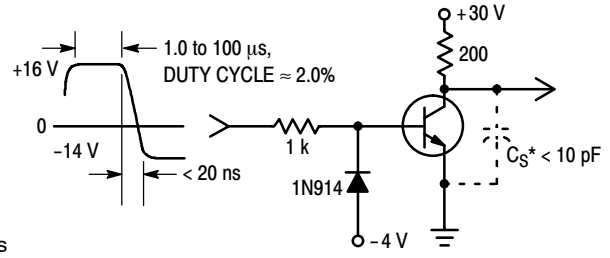

Figure 2. Turn-Off Time

Scope rise time <math>< 4 \text{ ns}</math>
 *Total shunt capacitance of test jig, connectors, and oscilloscope.

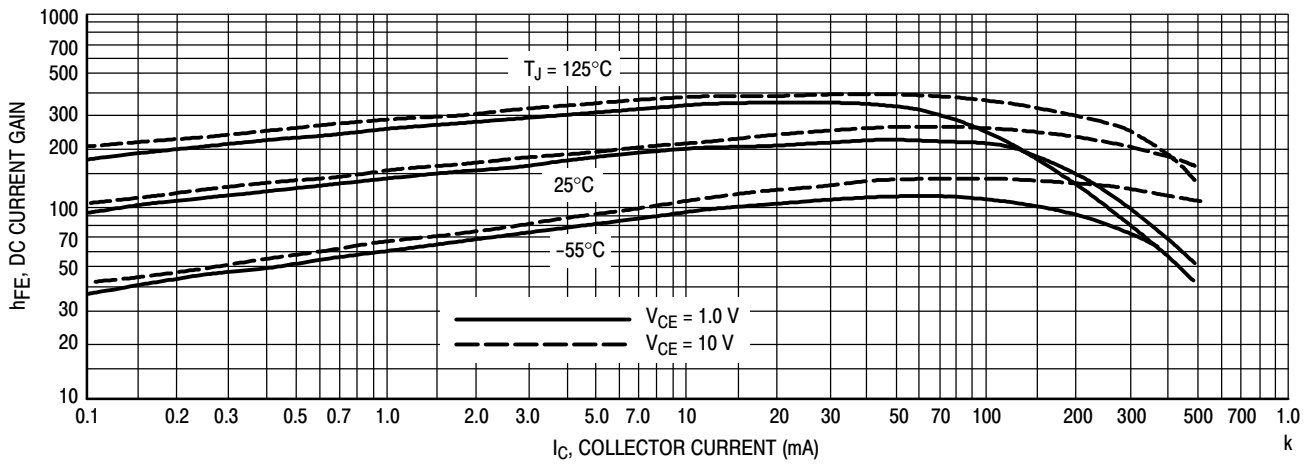

Figure 3. DC Current Gain

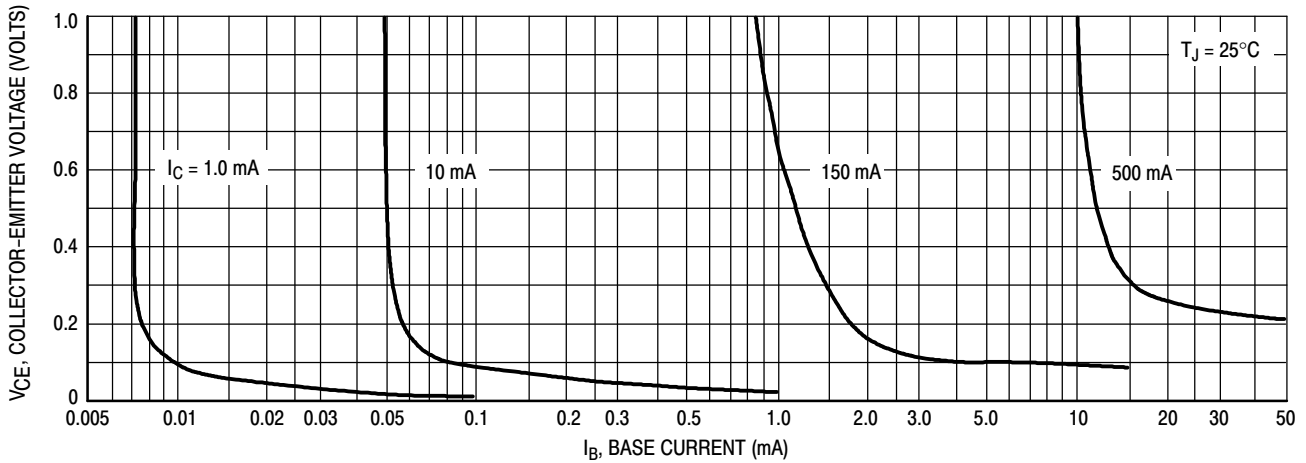

Figure 4. Collector Saturation Region

MBT2222ADW1, NSVBT2222ADW1

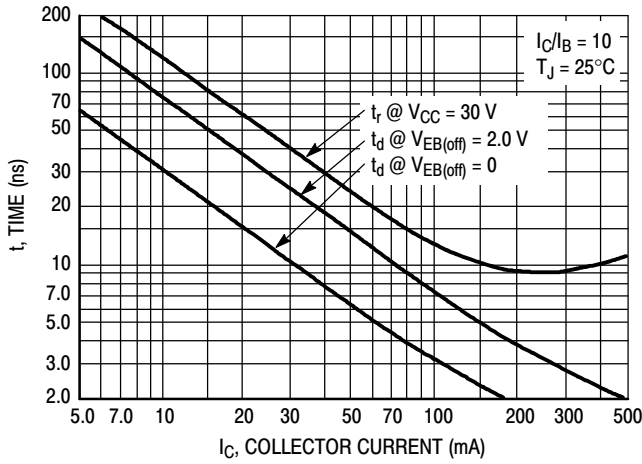

Figure 5. Turn-On Time

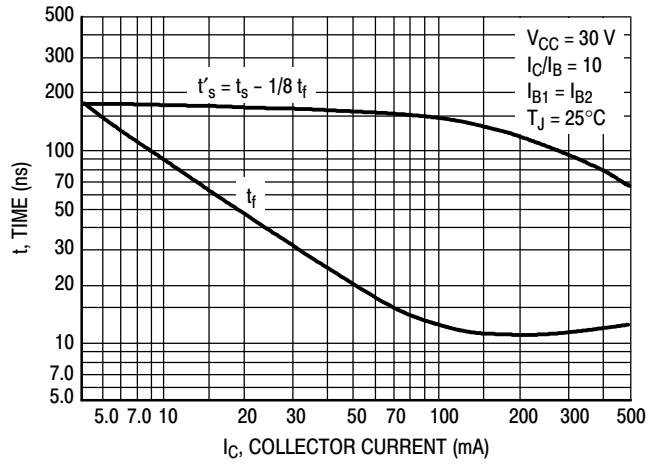

Figure 6. Turn-Off Time

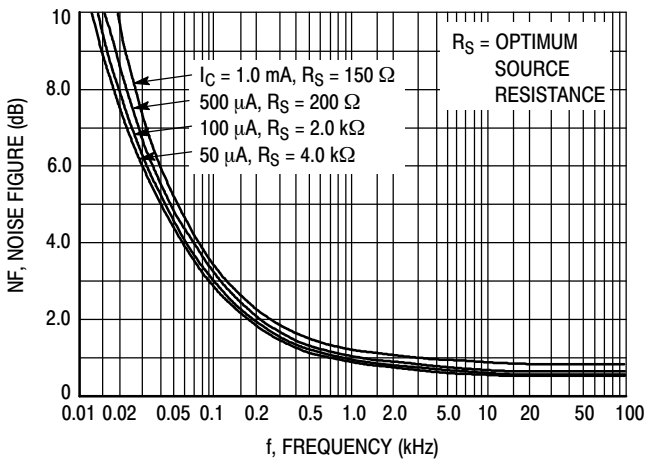

Figure 7. Frequency Effects

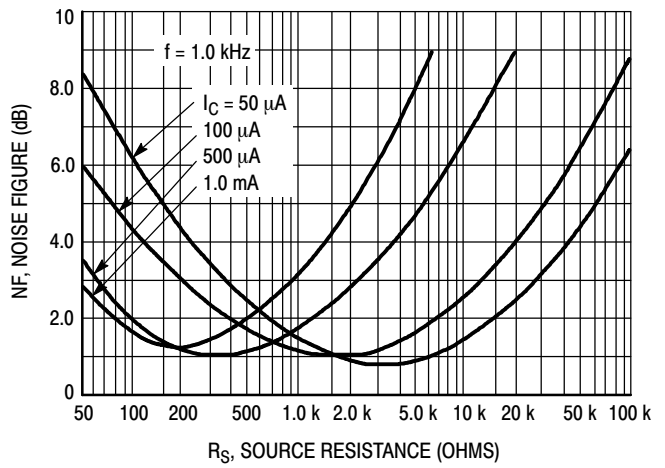

Figure 8. Source Resistance Effects

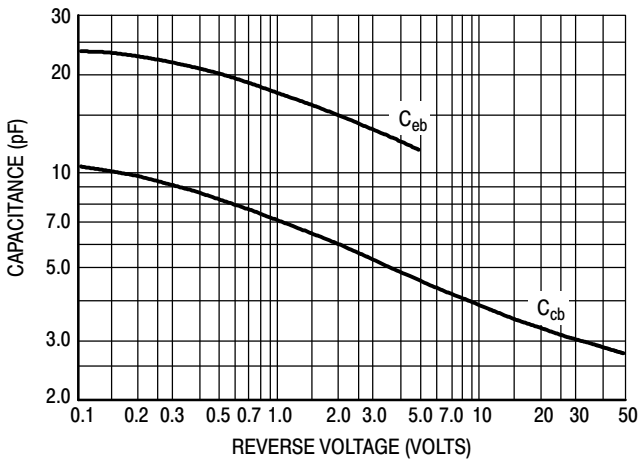

Figure 9. Capacitances

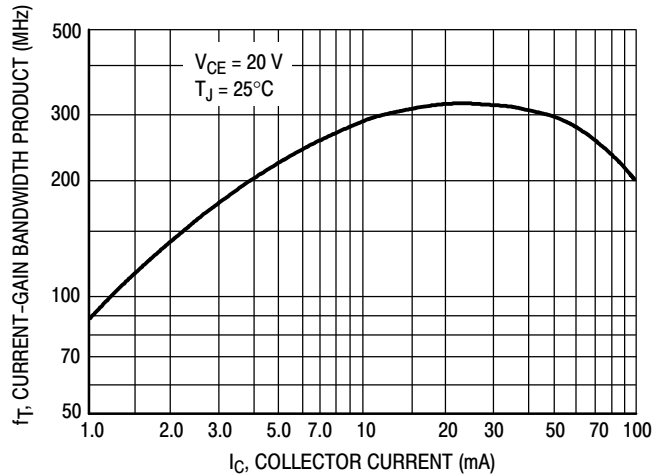

Figure 10. Current-Gain Bandwidth Product

MBT2222ADW1, NSVBT2222ADW1

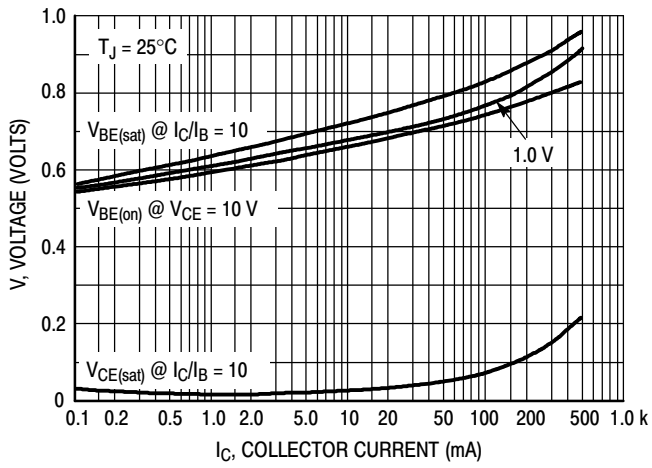

Figure 11. "On" Voltages

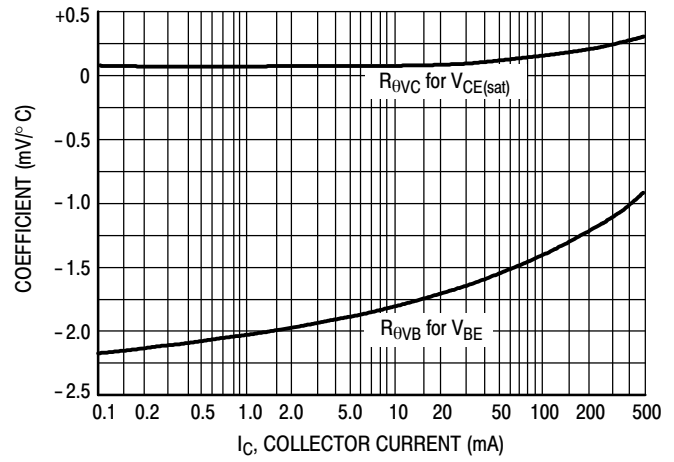
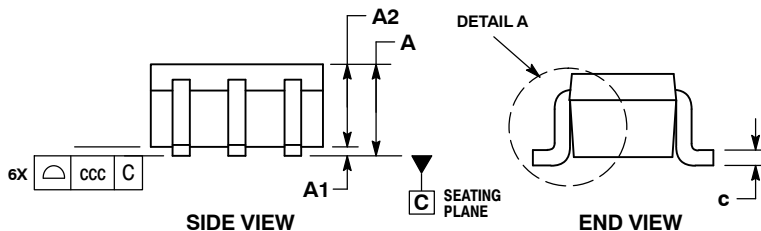
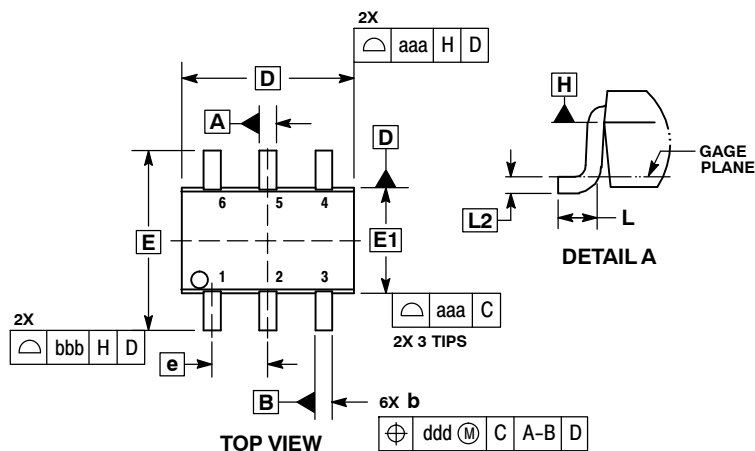

Figure 12. Temperature Coefficients

MBT2222ADW1, NSVBT2222ADW1

PACKAGE DIMENSIONS

SC-88/SC70-6/SOT-363
CASE 419B-02
ISSUE Y



NOTES:

1. DIMENSIONING AND TOLERANCING PER ASME Y14.5M, 1994.
2. CONTROLLING DIMENSION: MILLIMETERS.
3. DIMENSIONS D AND E1 DO NOT INCLUDE MOLD FLASH, PROTRUSIONS, OR GATE BURRS. MOLD FLASH, PROTRUSIONS, OR GATE BURRS SHALL NOT EXCEED 0.20 PER END.
4. DIMENSIONS D AND E1 AT THE OUTERMOST EXTREMES OF THE PLASTIC BODY AND DATUM H.
5. DATUMS A AND B ARE DETERMINED AT DATUM H.
6. DIMENSIONS b AND c APPLY TO THE FLAT SECTION OF THE LEAD BETWEEN 0.08 AND 0.15 FROM THE TIP.
7. DIMENSION b DOES NOT INCLUDE DAMBAR PROTRUSION. ALLOWABLE DAMBAR PROTRUSION SHALL BE 0.08 TOTAL IN EXCESS OF DIMENSION b AT MAXIMUM MATERIAL CONDITION. THE DAMBAR CANNOT BE LOCATED ON THE LOWER RADIUS OF THE FOOT.

DIM	MILLIMETERS			INCHES		
	MIN	NOM	MAX	MIN	NOM	MAX
A	---	---	1.10	---	---	0.043
A1	0.00	---	0.10	0.000	---	0.004
A2	0.70	0.90	1.00	0.027	0.035	0.039
b	0.15	0.20	0.25	0.006	0.008	0.010
C	0.08	0.15	0.22	0.003	0.006	0.009
D	1.80	2.00	2.20	0.070	0.078	0.086
E	2.00	2.10	2.20	0.078	0.082	0.086
E1	1.15	1.25	1.35	0.045	0.049	0.053
e	0.65 BSC			0.026 BSC		
L	0.26	0.36	0.46	0.010	0.014	0.018
L2	0.15 BSC			0.006 BSC		
aaa	0.15			0.006		
bbb	0.30			0.012		
ccc	0.10			0.004		
ddd	0.10			0.004		

STYLE 1:

1. EMITTER 2
2. BASE 2
3. COLLECTOR 1
4. EMITTER 1
5. BASE 1
6. COLLECTOR 2

RECOMMENDED SOLDERING FOOTPRINT*

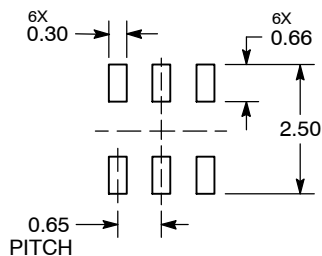

DIMENSIONS: MILLIMETERS

*For additional information on our Pb-Free strategy and soldering details, please download the ON Semiconductor Soldering and Mounting Techniques Reference Manual, SOLDERRM/D.

ON Semiconductor and are registered trademarks of Semiconductor Components Industries, LLC (SCILLC). SCILLC owns the rights to a number of patents, trademarks, copyrights, trade secrets, and other intellectual property. A listing of SCILLC's product/patent coverage may be accessed at www.onsemi.com/site/pdf/Patent-Marking.pdf. SCILLC reserves the right to make changes without further notice to any products herein. SCILLC makes no warranty, representation or guarantee regarding the suitability of its products for any particular purpose, nor does SCILLC assume any liability arising out of the application or use of any product or circuit, and specifically disclaims any and all liability, including without limitation special, consequential or incidental damages. "Typical" parameters which may be provided in SCILLC data sheets and/or specifications can and do vary in different applications and actual performance may vary over time. All operating parameters, including "Typicals" must be validated for each customer application by customer's technical experts. SCILLC does not convey any license under its patent rights nor the rights of others. SCILLC products are not designed, intended, or authorized for use as components in systems intended for surgical implant into the body, or other applications intended to support or sustain life, or for any other application in which the failure of the SCILLC product could create a situation where personal injury or death may occur. Should Buyer purchase or use SCILLC products for any such unintended or unauthorized application, Buyer shall indemnify and hold SCILLC and its officers, employees, subsidiaries, affiliates, and distributors harmless against all claims, costs, damages, and expenses, and reasonable attorney fees arising out of, directly or indirectly, any claim of personal injury or death associated with such unintended or unauthorized use, even if such claim alleges that SCILLC was negligent regarding the design or manufacture of the part. SCILLC is an Equal Opportunity/Affirmative Action Employer. This literature is subject to all applicable copyright laws and is not for resale in any manner.

PUBLICATION ORDERING INFORMATION

LITERATURE FULFILLMENT:
Literature Distribution Center for ON Semiconductor
P.O. Box 5163, Denver, Colorado 80217 USA
Phone: 303-675-2175 or 800-344-3860 Toll Free USA/Canada
Fax: 303-675-2176 or 800-344-3867 Toll Free USA/Canada
Email: orderlit@onsemi.com

N. American Technical Support: 800-282-9855 Toll Free
USA/Canada
Europe, Middle East and Africa Technical Support:
Phone: 421 33 790 2910
Japan Customer Focus Center
Phone: 81-3-5817-1050

ON Semiconductor Website: www.onsemi.com
Order Literature: <http://www.onsemi.com/orderlit>

For additional information, please contact your local Sales Representative

Mouser Electronics

Authorized Distributor

Click to View Pricing, Inventory, Delivery & Lifecycle Information:

[ON Semiconductor:](#)

[MBT2222ADW1T1G](#) [NSVBT2222ADW1T1G](#)