

# MJD47, NJVMJD47T4G, MJD50, NJVMJD50T4G

## High Voltage Power Transistors

### DPAK for Surface Mount Applications

Designed for line operated audio output amplifier, switchmode supply drivers and other switching applications.

#### Features

- Lead Formed for Surface Mount Applications in Plastic Sleeves (No Suffix)
- Electrically Similar to Popular TIP47, and TIP50
- Epoxy Meets UL 94 V-0 @ 0.125 in
- NJV Prefix for Automotive and Other Applications Requiring Unique Site and Control Change Requirements; AEC-Q101 Qualified and PPAP Capable
- These Devices are Pb-Free and are RoHS Compliant

#### MAXIMUM RATINGS

Rating	Symbol	Max	Unit
Collector-Emitter Voltage MJD47, NJVMJD47T4G MJD50, NJVMJD50T4G	$V_{CEO}$	250 400	Vdc
Collector-Base Voltage MJD47, NJVMJD47T4G MJD50, NJVMJD50T4G	$V_{CB}$	350 500	Vdc
Emitter-Base Voltage	$V_{EB}$	5	Vdc
Collector Current – Continuous	$I_C$	1	Adc
Collector Current – Peak	$I_{CM}$	2	Adc
Base Current	$I_B$	0.6	Adc
Total Power Dissipation @ $T_C = 25^\circ\text{C}$ Derate above $25^\circ\text{C}$	$P_D$	15 0.12	W W/ $^\circ\text{C}$
Total Power Dissipation (Note 1) @ $T_A = 25^\circ\text{C}$ Derate above $25^\circ\text{C}$	$P_D$	1.56 0.0125	W W/ $^\circ\text{C}$
Operating and Storage Junction Temperature Range	$T_J, T_{stg}$	-65 to +150	$^\circ\text{C}$
ESD – Human Body Model	HBM	3B	V
ESD – Machine Model	MM	C	V

Stresses exceeding those listed in the Maximum Ratings table may damage the device. If any of these limits are exceeded, device functionality should not be assumed, damage may occur and reliability may be affected.

1. These ratings are applicable when surface mounted on the minimum pad sizes recommended.



ON Semiconductor®

<http://onsemi.com>

**NPN SILICON POWER  
TRANSISTORS  
1 AMPERE  
250, 400 VOLTS, 15 WATTS**

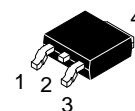
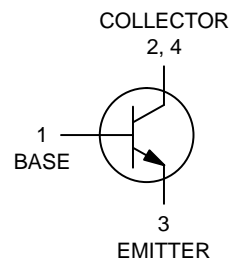

**DPAK  
CASE 369C  
STYLE 1**

#### MARKING DIAGRAM

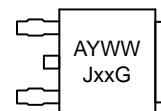

A = Assembly Location  
Y = Year  
WW = Work Week  
Jxx = Device Code  
xx = 47 or 50  
G = Pb-Free Package

#### ORDERING INFORMATION

See detailed ordering and shipping information in the package dimensions section on page 5 of this data sheet.

# MJD47, NJVMJD47T4G, MJD50, NJVMJD50T4G

## THERMAL CHARACTERISTICS

Characteristic	Symbol	Max	Unit
Thermal Resistance Junction-to-Case	$R_{\theta JC}$	8.33	°C/W
Thermal Resistance Junction-to-Ambient (Note 2)	$R_{\theta JA}$	80	°C/W
Lead Temperature for Soldering Purpose	$T_L$	260	°C

2. These ratings are applicable when surface mounted on the minimum pad sizes recommended.

## ELECTRICAL CHARACTERISTICS ( $T_C = 25^\circ\text{C}$ unless otherwise noted)

Characteristic	Symbol	Min	Max	Unit
----------------	--------	-----	-----	------

### OFF CHARACTERISTICS

Collector-Emitter Sustaining Voltage (Note 3) ( $I_C = 30\text{ mAdc}$ , $I_B = 0$ ) MJD47, NJVMJD47T4G MJD50, NJVMJD50T4G	$V_{CE(sus)}$	250 400	- -	Vdc
Collector Cutoff Current ( $V_{CE} = 150\text{ Vdc}$ , $I_B = 0$ ) MJD47, NJVMJD47T4G ( $V_{CE} = 300\text{ Vdc}$ , $I_B = 0$ ) MJD50, NJVMJD50T4G	$I_{CEO}$	- -	0.2 0.2	mAdc
Collector Cutoff Current ( $V_{CE} = 350\text{ Vdc}$ , $V_{BE} = 0$ ) MJD47, NJVMJD47T4G ( $V_{CE} = 500\text{ Vdc}$ , $V_{BE} = 0$ ) MJD50, NJVMJD50T4G	$I_{CES}$	- -	0.1 0.1	mAdc
Emitter Cutoff Current ( $V_{BE} = 5\text{ Vdc}$ , $I_C = 0$ )	$I_{EBO}$	-	1	mAdc

### ON CHARACTERISTICS (Note 3)

DC Current Gain ( $I_C = 0.3\text{ Adc}$ , $V_{CE} = 10\text{ Vdc}$ ) ( $I_C = 1\text{ Adc}$ , $V_{CE} = 10\text{ Vdc}$ )	$h_{FE}$	30 10	150 -	-
Collector-Emitter Saturation Voltage ( $I_C = 1\text{ Adc}$ , $I_B = 0.2\text{ Adc}$ )	$V_{CE(sat)}$	-	1	Vdc
Base-Emitter On Voltage ( $I_C = 1\text{ Adc}$ , $V_{CE} = 10\text{ Vdc}$ )	$V_{BE(on)}$	-	1.5	Vdc

### DYNAMIC CHARACTERISTICS

Current Gain – Bandwidth Product ( $I_C = 0.2\text{ Adc}$ , $V_{CE} = 10\text{ Vdc}$ , $f = 2\text{ MHz}$ )	$f_T$	10	-	MHz
Small-Signal Current Gain ( $I_C = 0.2\text{ Adc}$ , $V_{CE} = 10\text{ Vdc}$ , $f = 1\text{ kHz}$ )	$h_{fe}$	25	-	-

3. Pulse Test: Pulse Width  $\leq 300\ \mu\text{s}$ , Duty Cycle  $\leq 2\%$ .

# MJD47, NJVMJD47T4G, MJD50, NJVMJD50T4G

## TYPICAL CHARACTERISTICS

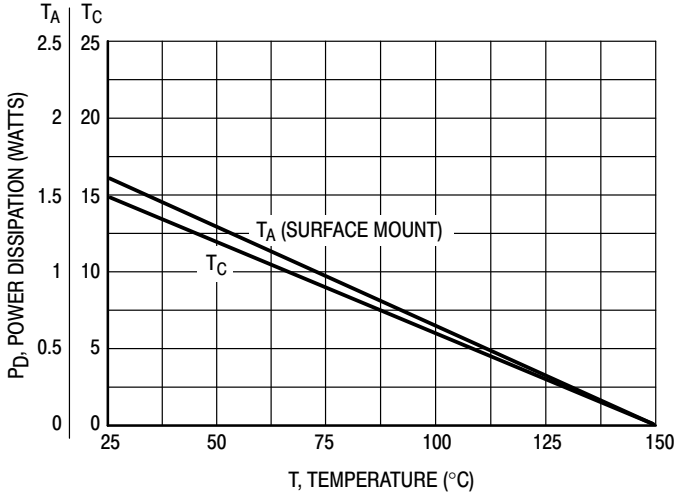

Figure 1. Power Derating

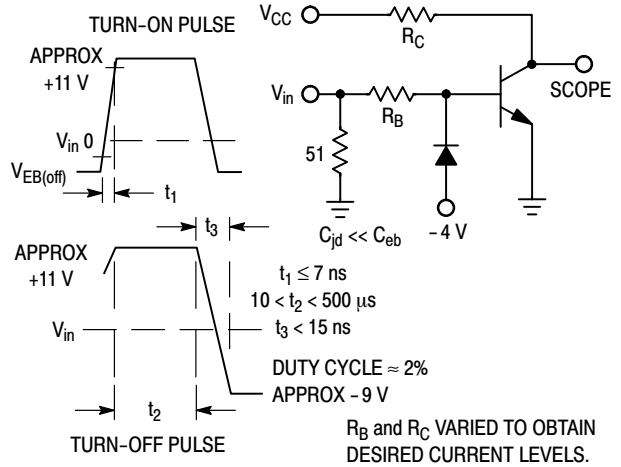

Figure 2. Switching Time Equivalent Circuit

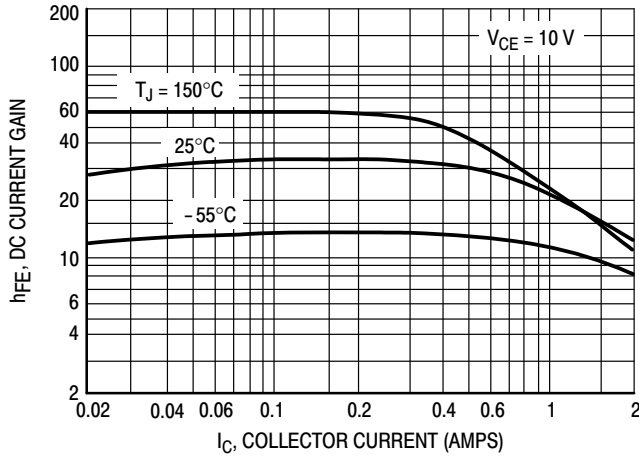

Figure 3. DC Current Gain

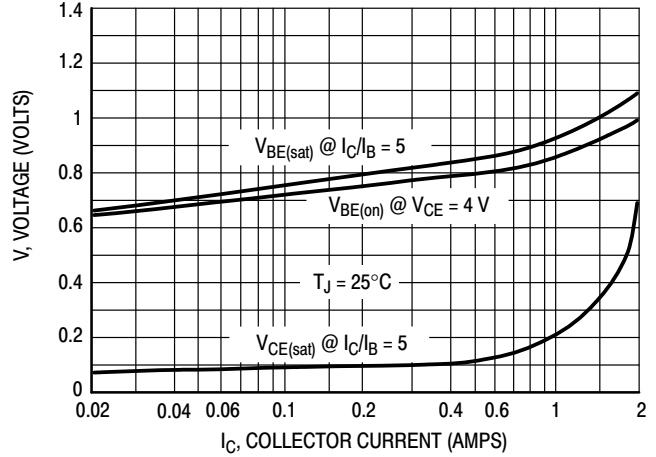

Figure 4. "On" Voltages

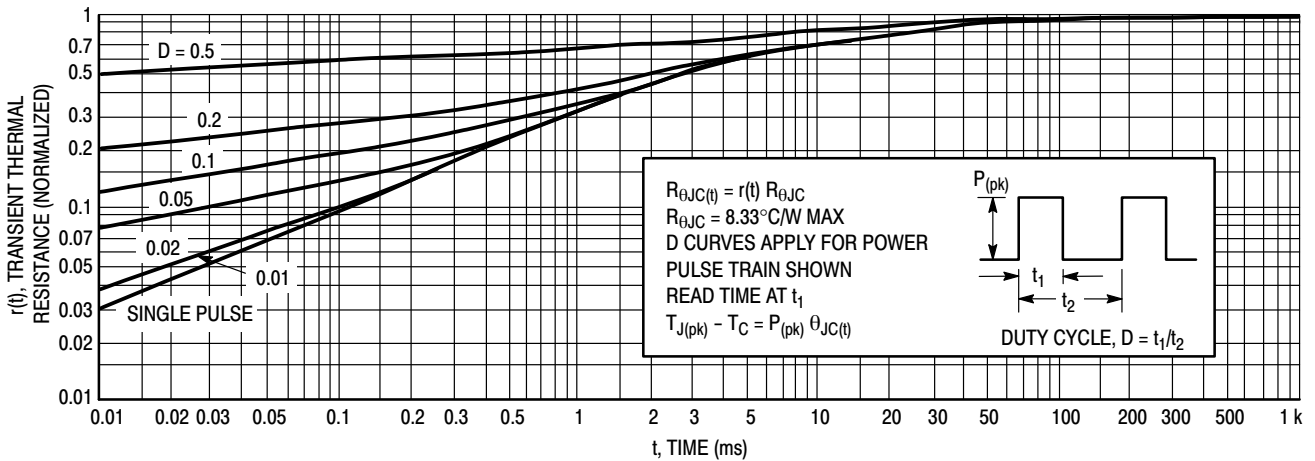

Figure 5. Thermal Response

# MJD47, NJVMJD47T4G, MJD50, NJVMJD50T4G

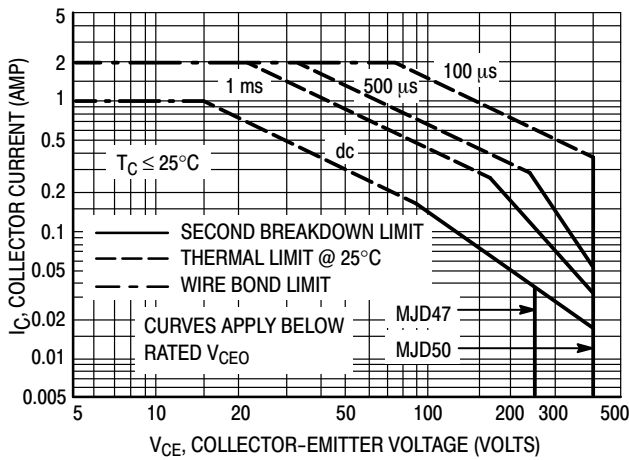

Figure 6. Active Region Safe Operating Area

There are two limitations on the power handling ability of a transistor: average junction temperature and second breakdown. Safe operating area curves indicate  $I_C - V_{CE}$  limits of the transistor that must be observed for reliable operation; i.e., the transistor must not be subjected to greater dissipation than the curves indicate.

The data of Figure 6 is based on  $T_{J(pk)} = 150^\circ\text{C}$ ;  $T_C$  is variable depending on conditions. Second breakdown pulse limits are valid for duty cycles to 10% provided  $T_{J(pk)} \leq 150^\circ\text{C}$ .  $T_{J(pk)}$  may be calculated from the data in Figure 5. At high case temperatures, thermal limitations will reduce the power that can be handled to values less than the limitations imposed by second breakdown.

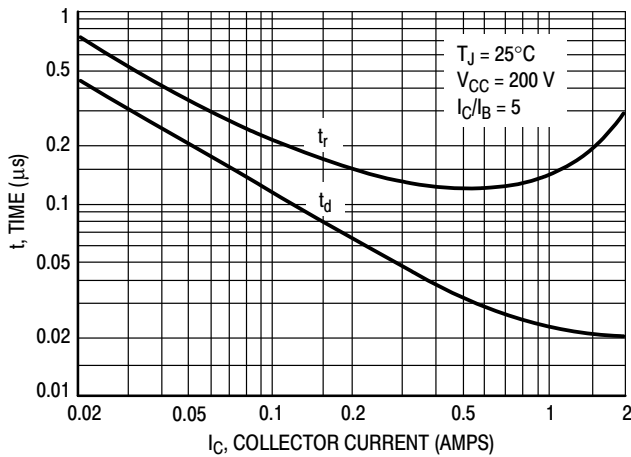

Figure 7. Turn-On Time

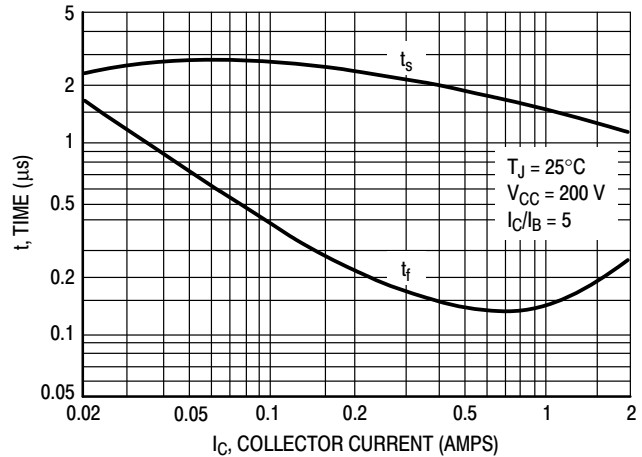

Figure 8. Turn-Off Time

## MJD47, NJVMJD47T4G, MJD50, NJVMJD50T4G

### ORDERING INFORMATION

Device	Package	Shipping†
MJD47G	369C (Pb-Free)	75 Units / Rail
MJD47T4G	369C (Pb-Free)	2,500 / Tape & Reel
NJVMJD47T4G*	369C (Pb-Free)	2,500 / Tape & Reel
MJD50G	369C (Pb-Free)	75 Units / Rail
MJD50T4G	369C (Pb-Free)	2,500 / Tape & Reel
NJVMJD50T4G*	369C (Pb-Free)	2,500 / Tape & Reel

†For information on tape and reel specifications, including part orientation and tape sizes, please refer to our Tape and Reel Packaging Specification Brochure, BRD8011/D.

\*NJV Prefix for Automotive and Other Applications Requiring Unique Site and Control Change Requirements; AEC-Q101 Qualified and PPAP Capable.

# MJD47, NJVMJD47T4G, MJD50, NJVMJD50T4G

## PACKAGE DIMENSIONS

### DPAK CASE 369C ISSUE D

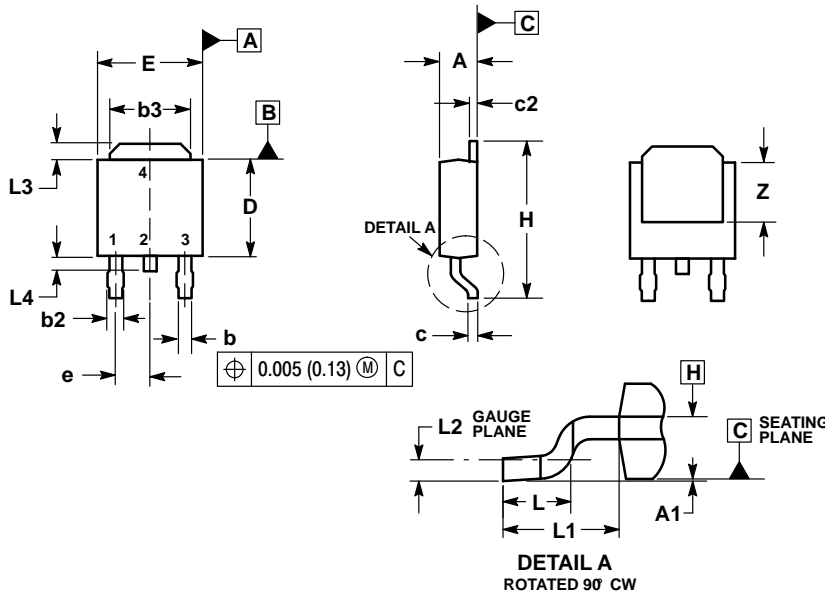

NOTES:

1. DIMENSIONING AND TOLERANCING PER ASME Y14.5M, 1994.
2. CONTROLLING DIMENSION: INCHES.
3. THERMAL PAD CONTOUR OPTIONAL WITHIN DIMENSIONS b3, L3 and Z.
4. DIMENSIONS D AND E DO NOT INCLUDE MOLD FLASH, PROTRUSIONS, OR BURRS. MOLD FLASH, PROTRUSIONS, OR GATE BURRS SHALL NOT EXCEED 0.006 INCHES PER SIDE.
5. DIMENSIONS D AND E ARE DETERMINED AT THE OUTERMOST EXTREMES OF THE PLASTIC BODY.
6. DATUMS A AND B ARE DETERMINED AT DATUM PLANE H.

DIM	INCHES		MILLIMETERS	
	MIN	MAX	MIN	MAX
A	0.086	0.094	2.18	2.38
A1	0.000	0.005	0.00	0.13
b	0.025	0.035	0.63	0.89
b2	0.030	0.045	0.76	1.14
b3	0.180	0.215	4.57	5.46
c	0.018	0.024	0.46	0.61
c2	0.018	0.024	0.46	0.61
D	0.235	0.245	5.97	6.22
E	0.250	0.265	6.35	6.73
e	0.090 BSC		2.29 BSC	
H	0.370	0.410	9.40	10.41
L	0.055	0.070	1.40	1.78
L1	0.108 REF		2.74 REF	
L2	0.020 BSC		0.51 BSC	
L3	0.035	0.050	0.89	1.27
L4	---		---	
Z	0.155	---	3.93	---

### SOLDERING FOOTPRINT\*

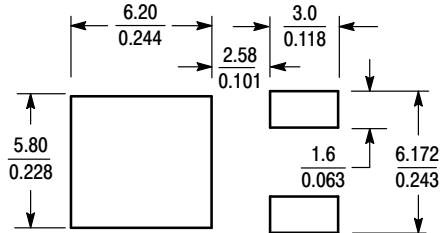

SCALE 3:1 (mm/inches)

STYLE 1:

1. BASE
2. COLLECTOR
3. EMITTER
4. COLLECTOR

\*For additional information on our Pb-Free strategy and soldering details, please download the ON Semiconductor Soldering and Mounting Techniques Reference Manual, SOLDERRM/D.

ON Semiconductor and are registered trademarks of Semiconductor Components Industries, LLC (SCILLC). SCILLC owns the rights to a number of patents, trademarks, copyrights, trade secrets, and other intellectual property. A listing of SCILLC's product/patent coverage may be accessed at [www.onsemi.com/site/pdf/Patent-Marking.pdf](http://www.onsemi.com/site/pdf/Patent-Marking.pdf). SCILLC reserves the right to make changes without further notice to any products herein. SCILLC makes no warranty, representation or guarantee regarding the suitability of its products for any particular purpose, nor does SCILLC assume any liability arising out of the application or use of any product or circuit, and specifically disclaims any and all liability, including without limitation special, consequential or incidental damages. "Typical" parameters which may be provided in SCILLC data sheets and/or specifications can and do vary in different applications and actual performance may vary over time. All operating parameters, including "Typicals" must be validated for each customer application by customer's technical experts. SCILLC does not convey any license under its patent rights nor the rights of others. SCILLC products are not designed, intended, or authorized for use as components in systems intended for surgical implant into the body, or other applications intended to support or sustain life, or for any other application in which the failure of the SCILLC product could create a situation where personal injury or death may occur. Should Buyer purchase or use SCILLC products for any such unintended or unauthorized application, Buyer shall indemnify and hold SCILLC and its officers, employees, subsidiaries, affiliates, and distributors harmless against all claims, costs, damages, and expenses, and reasonable attorney fees arising out of, directly or indirectly, any claim of personal injury or death associated with such unintended or unauthorized use, even if such claim alleges that SCILLC was negligent regarding the design or manufacture of the part. SCILLC is an Equal Opportunity/Affirmative Action Employer. This literature is subject to all applicable copyright laws and is not for resale in any manner.

### PUBLICATION ORDERING INFORMATION

LITERATURE FULFILLMENT:

Literature Distribution Center for ON Semiconductor  
P.O. Box 5163, Denver, Colorado 80217 USA  
Phone: 303-675-2175 or 800-344-3860 Toll Free USA/Canada  
Fax: 303-675-2176 or 800-344-3867 Toll Free USA/Canada  
Email: [orderlit@onsemi.com](mailto:orderlit@onsemi.com)

N. American Technical Support: 800-282-9855 Toll Free  
USA/Canada  
Europe, Middle East and Africa Technical Support:  
Phone: 421 33 790 2910  
Japan Customer Focus Center  
Phone: 81-3-5817-1050

ON Semiconductor Website: [www.onsemi.com](http://www.onsemi.com)

Order Literature: <http://www.onsemi.com/orderlit>

For additional information, please contact your local Sales Representative

# Mouser Electronics

Authorized Distributor

Click to View Pricing, Inventory, Delivery & Lifecycle Information:

[ON Semiconductor:](#)

[MJD47G](#) [MJD47T4G](#) [MJD50G](#) [MJD50T4G](#) [NJVMJD47T4G](#)