

## Small signal Schottky diodes

Datasheet – production data

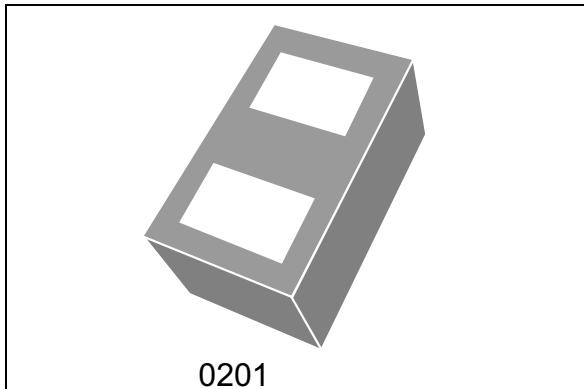

### Features

- Very low conduction losses
- Negligible switching losses
- 0201 package
- Low capacitance diode
- ECOPACK<sup>®</sup>2 and RoHS compliant component

### Description

The BAT30F4 uses 30 V Schottky barrier diodes in a 0201 package. This device is intended to be used in smartphones, and is especially suited for rail to rail protection where its low forward voltage drop will help designers to get an efficient protection of their ICs.

**Table 1. Device summary**

Symbol	Value
$V_{RRM}$	30 V
$T_j$ (max)	85 °C
$I_F$	300 mA

**Figure 1. Pin configuration and marking**

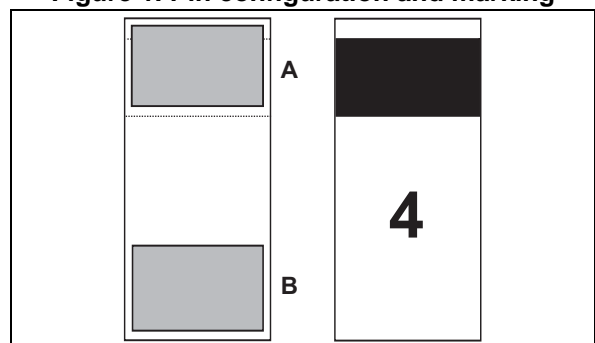

**Figure 2. Schematic**

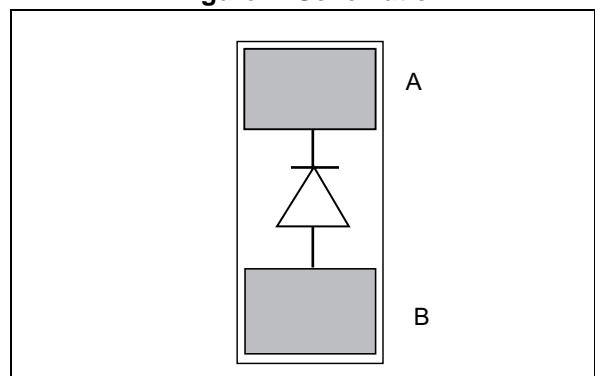

# 1 Characteristics

**Table 2. Absolute ratings (limiting values at 25 °C, unless otherwise specified)**

Symbol	Parameter	Value	Unit
$V_{RRM}$	Repetitive peak reverse voltage	30	V
$I_F$	Continuous forward current	300	mA
$I_{FSM}$	Surge non repetitive forward current	$t_p = 10$ ms sinusoidal	A
$P_D^{(1)}$	Power dissipation	200	mW
$T_{stg}$	Storage temperature range	-55 to +150	°C
$T_{op}$	Operating junction temperature range	-30 to +85	°C
$T_j$	Maximum junction temperature in DC forward mode	150	°C
$T_L$	Maximum soldering temperature during 10 s	260	°C

1. On epoxy printed circuit board with minimum recommended footprint

**Table 3. Thermal parameter**

Symbol	Parameter	Value (typ.)	Unit
$R_{th(j-a)}$	Junction to ambient <sup>(1)</sup>	450	°C/W

1. On epoxy printed circuit board with minimum recommended footprint

**Table 4. Static electrical characteristics**

Symbol	Parameter	Test conditions	Min.	Typ.	Max.	Unit	
$I_R^{(1)}$	Reverse leakage current	$T_j = 25$ °C	$V_R = 10$ V	-	2.2	$\mu$ A	
		$T_j = 85$ °C		-	300		
		$T_j = 25$ °C	$V_R = 30$ V	-	50		
		$T_j = 85$ °C		-	1600		
$V_F^{(2)}$	Forward voltage drop	$T_j = 25$ °C	$I_F = 5$ mA	-	0.285	V	
		$T_j = 85$ °C		-	0.205		
		$T_j = 25$ °C	$I_F = 10$ mA	-	0.27		0.31
		$T_j = 85$ °C		-	0.24		
		$T_j = 25$ °C	$I_F = 100$ mA	-	0.39		0.44
		$T_j = 85$ °C		-	0.40		
		$T_j = 25$ °C	$I_F = 300$ mA	-	0.55		0.625
		$T_j = 85$ °C		-	0.64		

1. Pulse test:  $t_p = 5$  ms,  $\delta < 2\%$

2. Pulse test:  $t_p = 380$   $\mu$ s,  $\delta < 2\%$

Table 5. Dynamic characteristics

Symbol	Parameter	Test conditions	Min.	Typ.	Max.	Unit
C	Diode capacitance	$V_R = 1\text{ V}$ , $F = 1\text{ MHz}$	-	10	14	pF

Figure 3. Reverse leakage current versus reverse applied voltage (typical values)

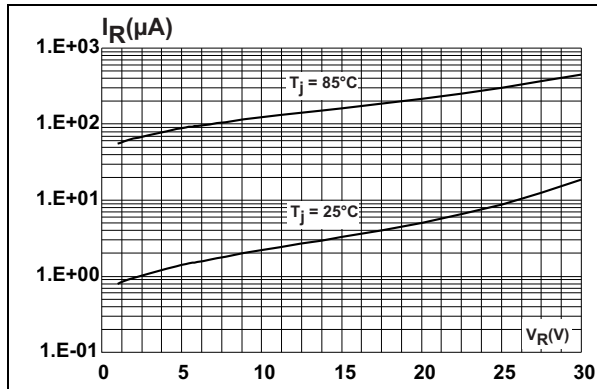

Figure 4. Forward voltage drop versus forward current (typical values)

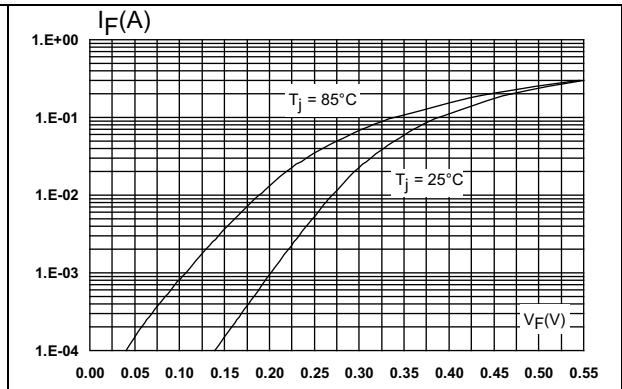

Figure 5. Relative variation of reverse leakage current versus junction temperature

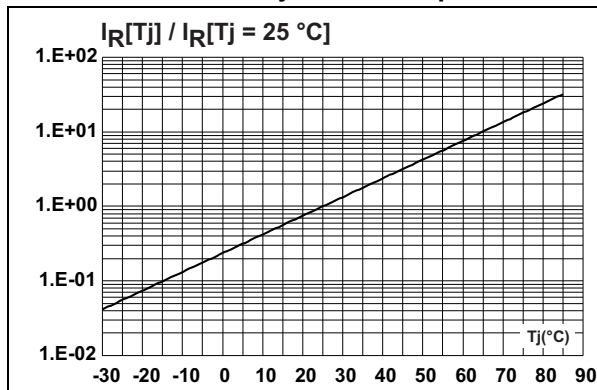

Figure 6. Junction capacitance versus reverse applied voltage (typical values)

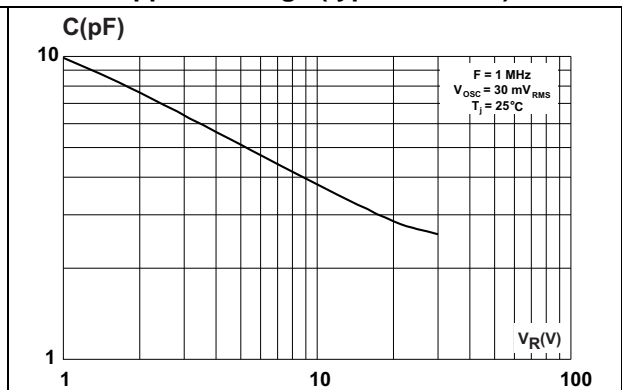
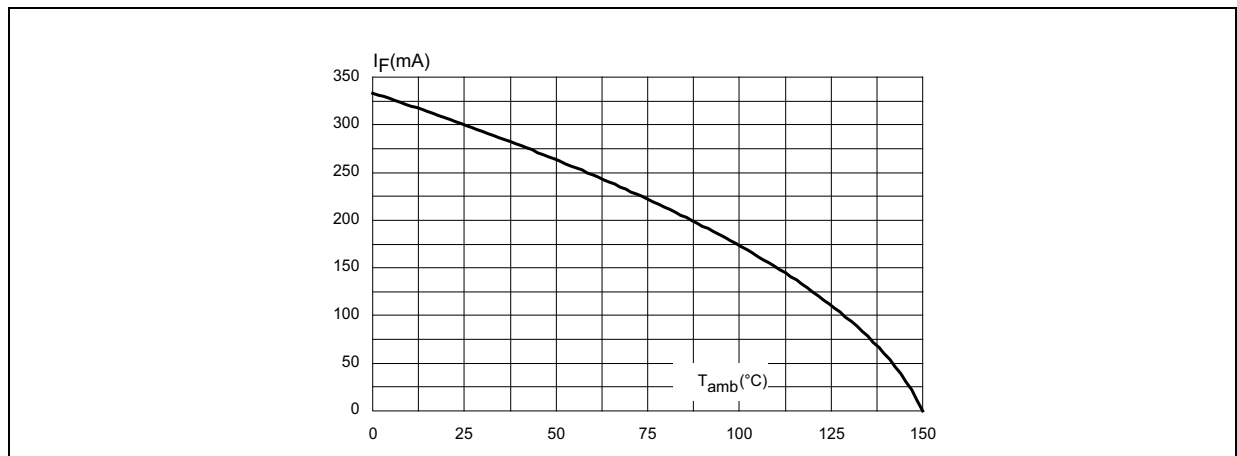

Figure 7. Continuous forward current versus ambient temperature



## 2 Package information

- Lead-free package

In order to meet environmental requirements, ST offers these devices in different grades of ECOPACK<sup>®</sup> packages, depending on their level of environmental compliance. ECOPACK<sup>®</sup> specifications, grade definitions and product status are available at: [www.st.com](http://www.st.com). ECOPACK<sup>®</sup> is an ST trademark.

### 2.1 0201 package information

Figure 8. 0201 package outline

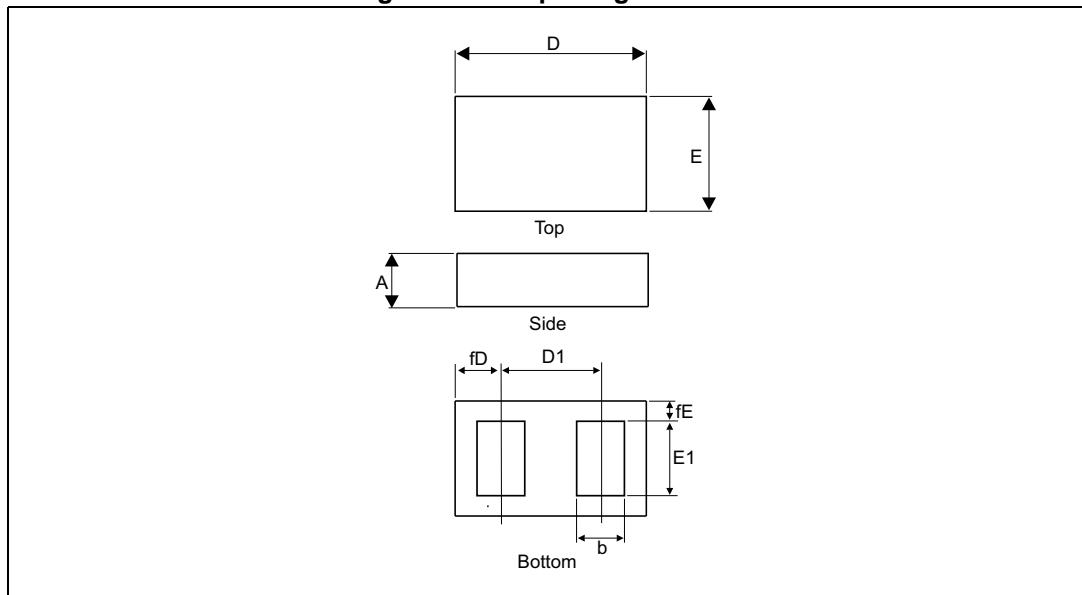

Table 6. 0201 package mechanical data

Ref.	Dimensions					
	Millimeters			Inches		
	Min.	Typ.	Max.	Min.	Typ.	Max.
A	0.28	0.3	0.32	0.0110	0.0118	0.0126
b	0.125	0.14	0.155	0.0049	0.0055	0.0061
D	0.57	0.6	0.63	0.0224	0.0236	0.0248
D1		0.35			0.0138	
E	0.27	0.3	0.33	0.0106	0.0118	0.0130
E1	0.175	0.19	0.205	0.0069	0.0075	0.0081
fE	0.065	0.08	0.095	0.0026	0.0031	0.0037
fD	0.11	0.125	0.13	0.0043	0.0049	0.0051

Figure 9. Footprint in mm (inches)

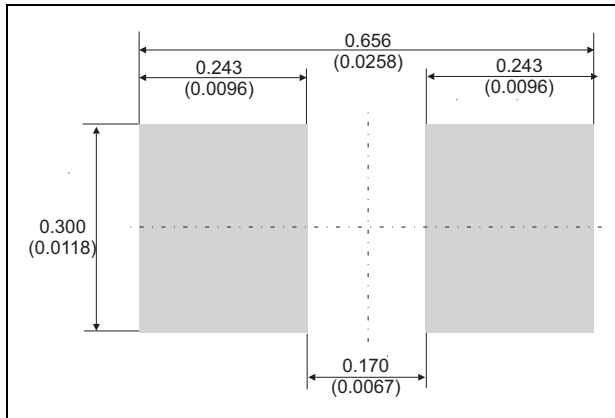
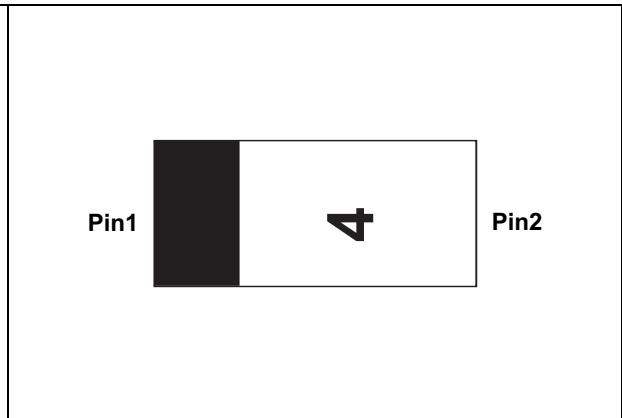
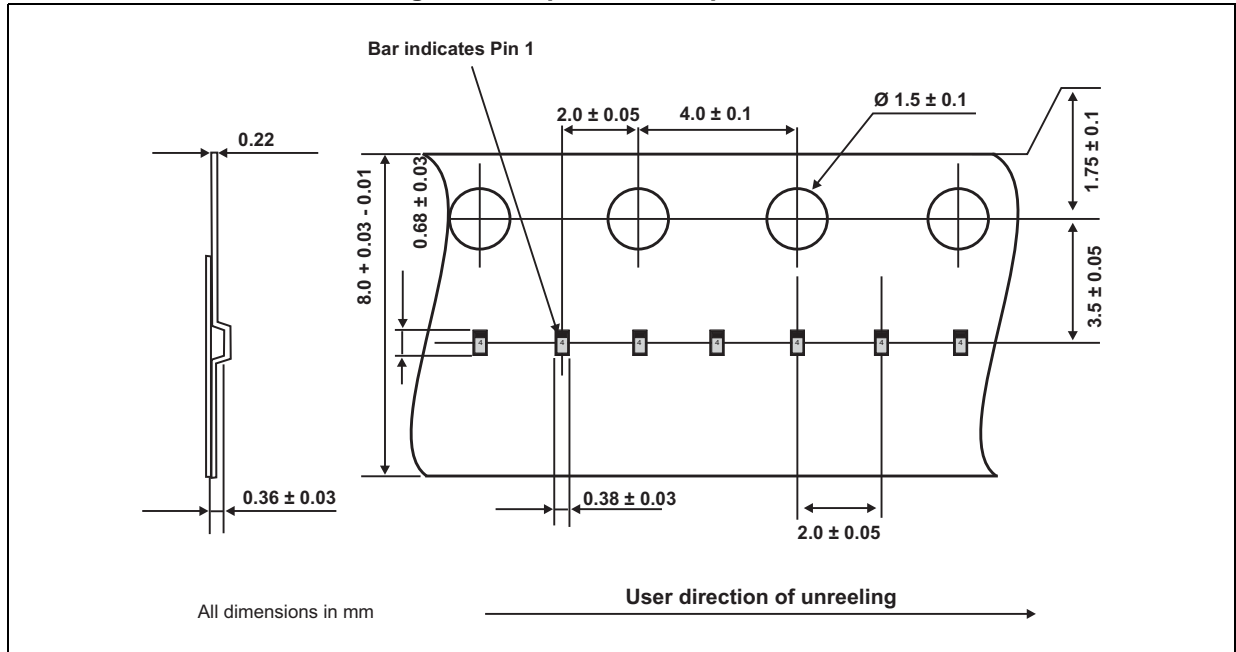

Figure 10. Marking



Note: The marking codes can be rotated by 90° or 180° to differentiate assembly location. In no case should this product marking be used to orient the component for its placement on a PCB. Only pin 1 mark is to be used for this purpose.

Figure 11. Tape and reel specification



### 3 Recommendation on PCB assembly

#### 3.1 Stencil opening design

1. General recommendations on stencil opening design
  - a) Stencil opening dimensions: L (Length), W (Width), T (Thickness).

**Figure 12. Stencil opening dimensions**

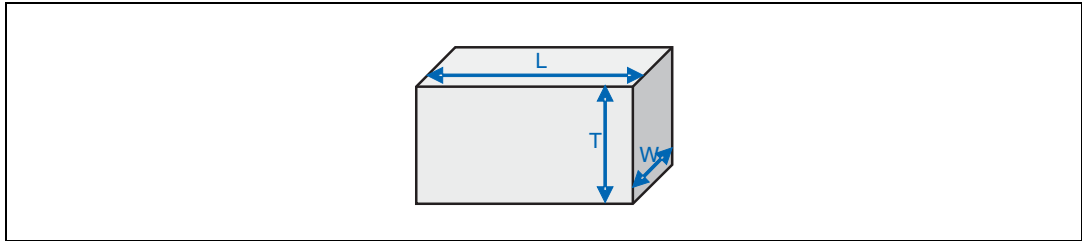

- b) General design rule
  - Stencil thickness (T) = 75 ~ 125 μm
  - Aspect Ratio =  $\frac{W}{T} \geq 1.5$
  - Aspect Area =  $\frac{L \times W}{2T(L + W)} \geq 0.66$

2. Recommended stencil window
  - a) Stencil opening thickness: 80 μm
  - b) Other dimensions: see [Figure 13](#)

**Figure 13. Recommended stencil window position, stencil opening thickness: 80 μm**

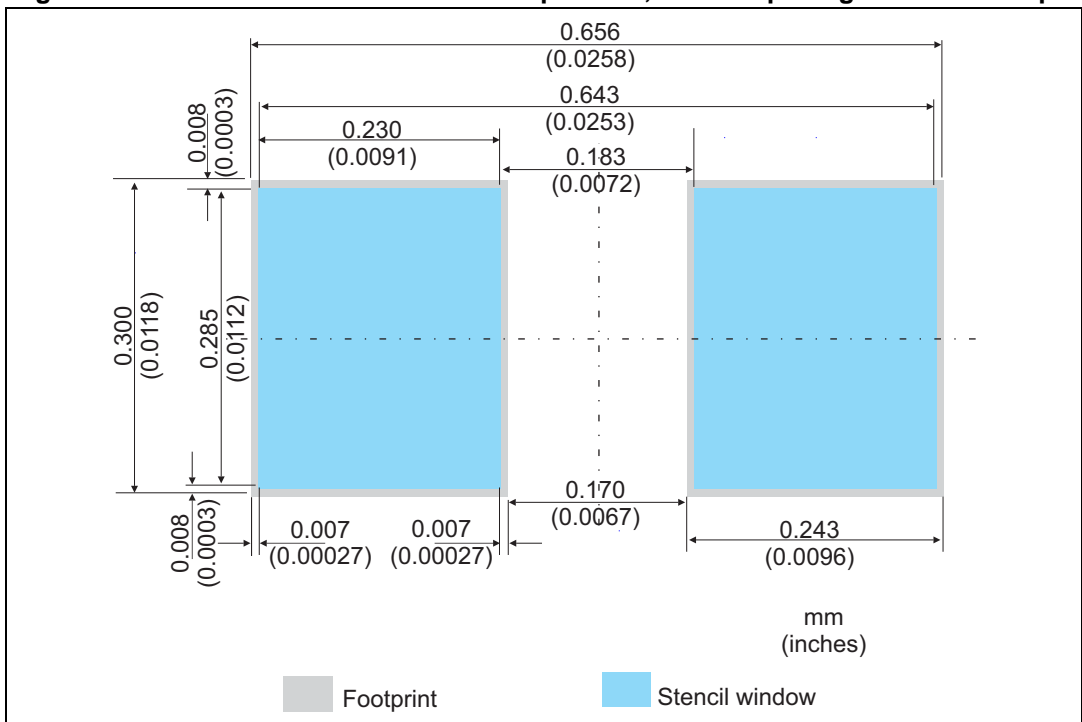

### 3.2 Solder paste

1. Use halide-free flux, qualification ROL0 according to ANSI/J-STD-004.
2. "No clean" solder paste recommended.
3. Offers a high tack force to resist component displacement during PCB movement.
4. Use solder paste with fine particles: Type 4 (powder particle size 20-48  $\mu\text{m}$  per IPC J STD-005).

### 3.3 Placement

1. Manual positioning is not recommended.
2. It is recommended to use the lead recognition capabilities of the placement system, not the outline centering.
3. Standard tolerance of  $\pm 0.05$  mm is recommended.
4. 1.0 N placement force is recommended. Too much placement force can lead to squeezed out solder paste and cause solder joints to short. Too low placement force can lead to insufficient contact between package and solder paste that could cause open solder joints or badly centered packages.
5. To improve the package placement accuracy, a bottom side optical control should be performed with a high resolution tool.
6. For assembly, a perfect supporting of the PCB (all the more on flexible PCB) is recommended during solder paste printing, pick and place and reflow soldering by using optimized tools.

### 3.4 PCB design preference

1. To control the solder paste amount, the closed via is recommended instead of open vias.
2. The position of tracks and open vias in the solder area should be well balanced. The symmetrical layout is recommended, in case any tilt phenomena caused by asymmetrical solder paste amount due to the solder flow away.

### 3.5 Reflow profile

Figure 14. ST ECOPACK® recommended soldering reflow profile for PCB mounting

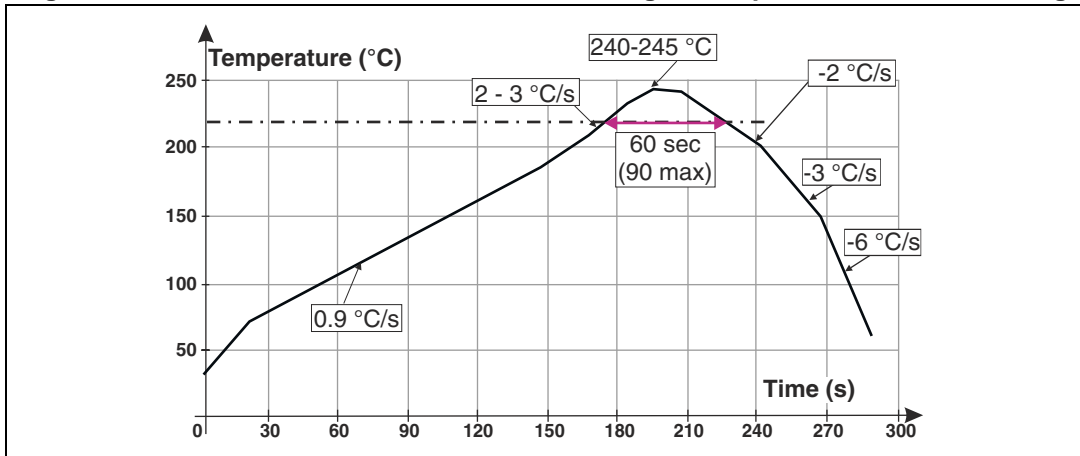

Note: Minimize air convection currents in the reflow oven to avoid component movement.



## 4 Ordering information

**Table 7. Ordering information**

Order code	Marking	Package	Weight	Base qty.	Delivery mode
BAT30F4	4 <sup>(1)</sup>	0201 CSP	0.116 mg	15000	Tape and reel

1. The marking codes can be rotated by 90° or 180° to differentiate assembly location

## 5 Revision history

**Table 8. Document revision history**

Date	Revision	Changes
13-May-2014	1	First issue
24-Nov-2014	2	Updated Table 2.
13-Apr-2015	3	Updated Features and Description.
11-Feb-2016	4	Updated Table 3 and Figure 4.
26-Feb-2016	5	Updated <a href="#">Table 2</a> . Added <a href="#">Table 3</a> , <a href="#">Table 5</a> and <a href="#">Figure 7</a> .

**IMPORTANT NOTICE – PLEASE READ CAREFULLY**

STMicroelectronics NV and its subsidiaries ("ST") reserve the right to make changes, corrections, enhancements, modifications, and improvements to ST products and/or to this document at any time without notice. Purchasers should obtain the latest relevant information on ST products before placing orders. ST products are sold pursuant to ST's terms and conditions of sale in place at the time of order acknowledgement.

Purchasers are solely responsible for the choice, selection, and use of ST products and ST assumes no liability for application assistance or the design of Purchasers' products.

No license, express or implied, to any intellectual property right is granted by ST herein.

Resale of ST products with provisions different from the information set forth herein shall void any warranty granted by ST for such product.

ST and the ST logo are trademarks of ST. All other product or service names are the property of their respective owners.

Information in this document supersedes and replaces information previously supplied in any prior versions of this document.

© 2016 STMicroelectronics – All rights reserved

# Mouser Electronics

Authorized Distributor

Click to View Pricing, Inventory, Delivery & Lifecycle Information:

[STMicroelectronics:](#)

[BAT30F4](#)