



ESDAxxL

Application Specific Discretes
A.S.D.

DUAL TRANSIL ARRAY FOR ESD PROTECTION

APPLICATIONS

Where transient overvoltage protection in ESD sensitive equipment is required, such as :

- COMPUTERS
- PRINTERS
- COMMUNICATION SYSTEMS

It is particularly recommended for the RS232 I/O port protection where the line interface withstands only with 2kV ESD surges.

FEATURES

- 2 UNIDIRECTIONAL TRANSIL FUNCTIONS.
- LOW LEAKAGE CURRENT : I_R max. < 20 μ A at V_{BR} .
- 300 W PEAK PULSE POWER (8/20 μ s)

DESCRIPTION

The ESDAxxL is a dual monolithic voltage suppressor designed to protect components which are connected to data and transmission lines against ESD.

It clamps the voltage just above the logic level supply for positive transients, and to a diode drop below ground for negative transients.

It can also work as bidirectional suppressor by connecting only pin1 and 2.

BENEFITS

High ESD protection level : up to 25 kV.

High integration.

Suitable for high density boards.

COMPLIES WITH THE FOLLOWING STANDARDS :

IEC61000-4-2 level 4

MIL STD 883C-Method 3015-6 : class 3.
(human body model)

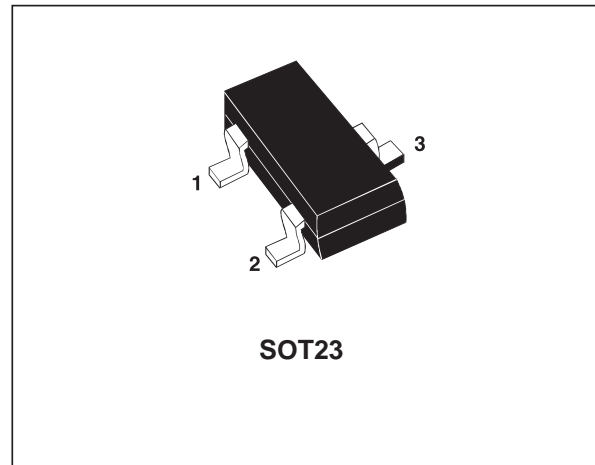

FUNCTIONAL DIAGRAM

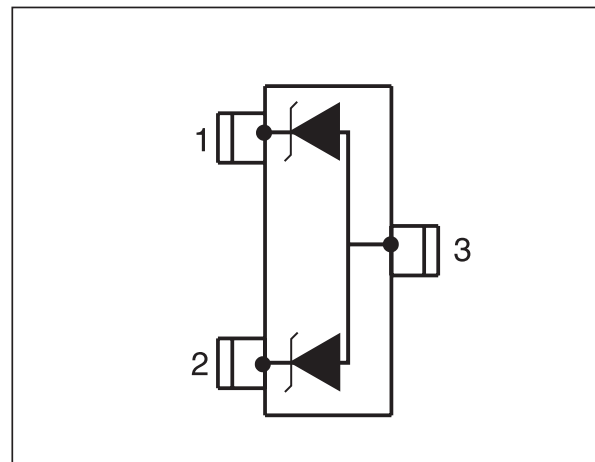

ESDAxxL

ABSOLUTE MAXIMUM RATINGS (T_{amb} = 25°C)

Symbol	Parameter	Value	Unit
V _{PP}	Electrostatic discharge MIL STD 883C - Method 3015-6 IEC61000-4-2 air discharge IEC61000-4-2 contact discharge	25 16 9	kV
P _{PP}	Peak pulse power (8/20 μs)	300	W
T _{stg} T _j	Storage temperature range Maximum junction temperature	- 55 to + 150 150	°C °C
T _L	Maximum lead temperature for soldering during 10s	260	°C
T _{op}	Operating temperature range	- 40 to + 125	°C

note 1: Evolution of functional parameters is given by curves.

ELECTRICAL CHARACTERISTICS (T_{amb} = 25°C)

Symbol	Parameter
V _{RM}	Stand-off voltage
V _{BR}	Breakdown voltage
V _{CL}	Clamping voltage
I _{RM}	Leakage current
I _{PP}	Peak pulse current
αT	Voltage temperature coefficient
C	Capacitance
R _d	Dynamic resistance
V _F	Forward voltage drop

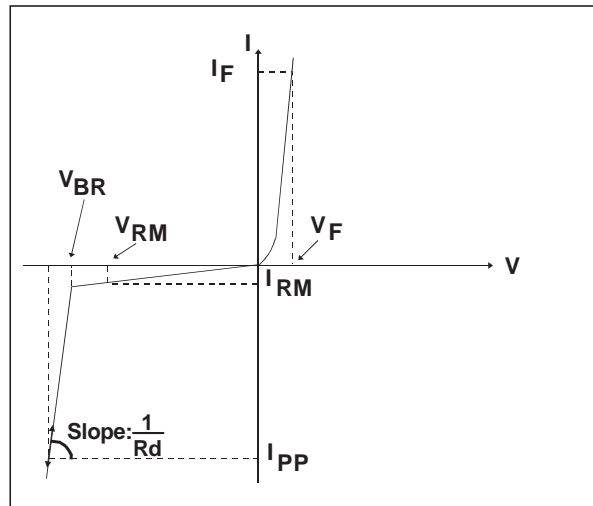

Types	V _{BR} @		I _R	I _{RM} @ V _{RM}		R _d typ. note 1	αT max. note 2	C typ. 0V bias	V _F @ I _F	
	min.	max.		max.	V _{RM}				V	mA
	V	V	mA	μA	V	mΩ	10 ⁻⁴ />C	pF	V	mA
ESDA5V3L	5.3	5.9	1	2	3	280	5	220	1.25	200
ESDA6V1L	6.1	7.2	1	20	5.25	350	6	140	1.25	200
ESDA14V2L	14.2	15.8	1	5	12	650	10	90	1.25	200
ESDA25L	25	30	1	1	24	1000	10	50	1.2	10

note 1 : Square pulse I_{pp} = 15A, t_p=2.5μs.

note 2 : Δ V_{BR} = αT * (T_{amb} - 25°C) * V_{BR} (25°C)

CALCULATION OF THE CLAMPING VOLTAGE

USE OF THE DYNAMIC RESISTANCE

The ESDA family has been designed to clamp fast spikes like ESD. Generally the PCB designers need to calculate easily the clamping voltage V_{CL} . This is why we give the dynamic resistance in addition to the classical parameters. The voltage across the protection cell can be calculated with the following formula:

$$V_{CL} = V_{BR} + R_d I_{PP}$$

Where I_{PP} is the peak current through the ESDA cell.

As the value of the dynamic resistance remains stable for a surge duration lower than $20\mu s$, the $2.5\mu s$ rectangular surge is well adapted. In addition both rise and fall times are optimized to avoid any parasitic phenomenon during the measurement of R_d .

DYNAMIC RESISTANCE MEASUREMENT

The short duration of the ESD has led us to prefer a more adapted test wave, as below defined, to the classical $8/20\mu s$ and $10/1000\mu s$ surges.

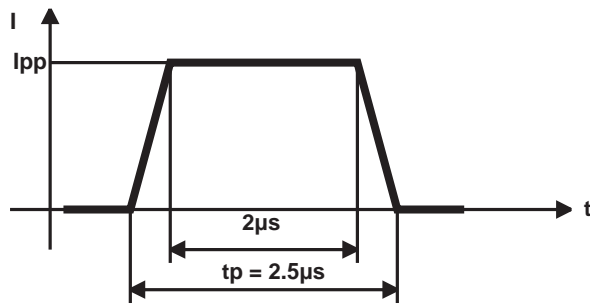

$2.5\mu s$ duration measurement wave.

Fig. 1: Peak power dissipation versus initial junction temperature.

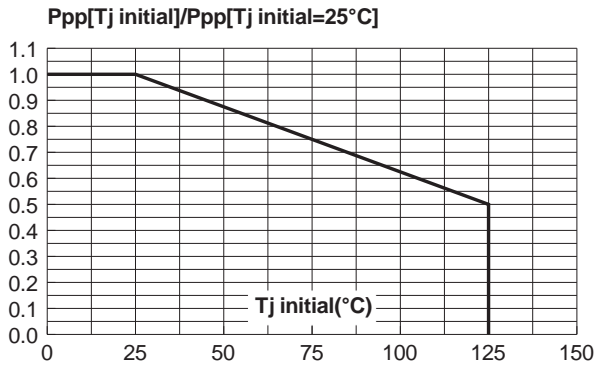

Fig. 2: Peak pulse power versus exponential pulse duration (Tj initial = 25 °C).

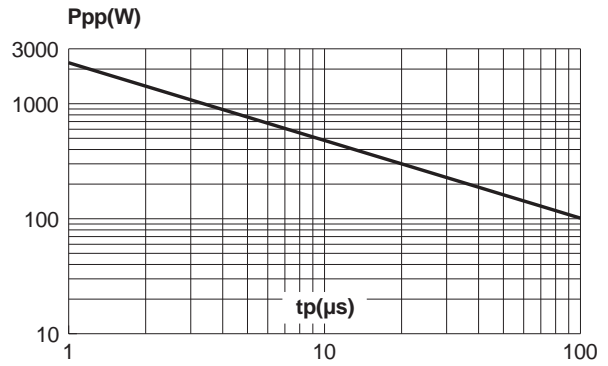

Fig. 3: Clamping voltage versus peak pulse current (Tj initial = 25 °C). Rectangular waveform tp = 2.5 µs.

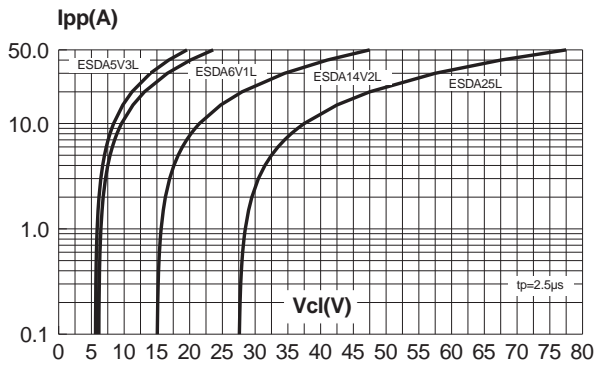

Fig. 4: Capacitance versus reverse applied voltage (typical values).

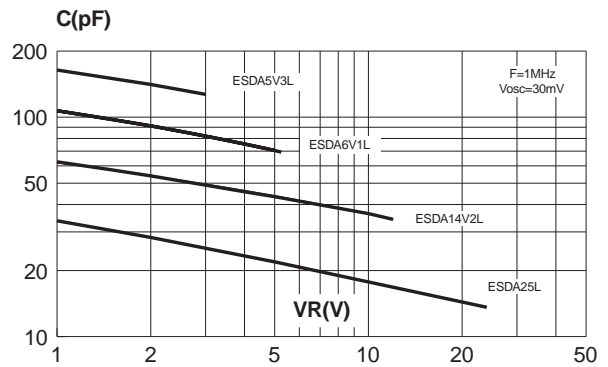

Fig. 5: Relative variation of leakage current versus junction temperature (typical values).

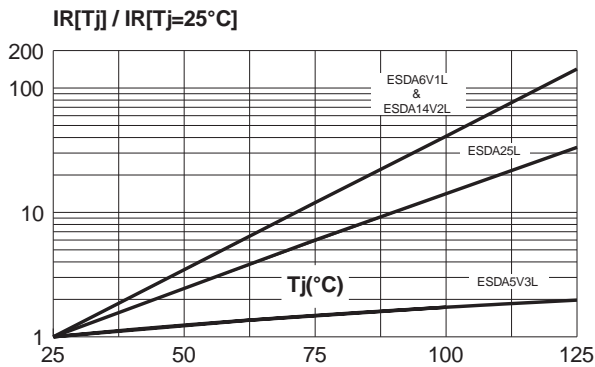
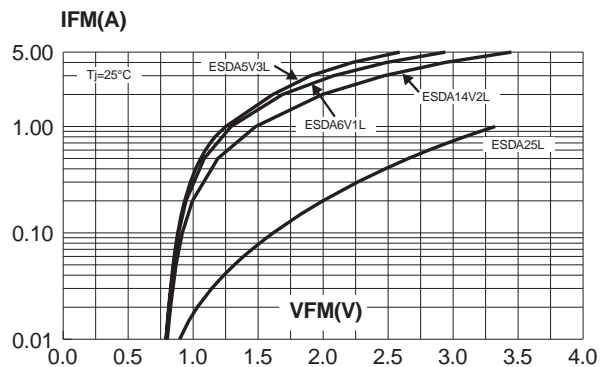

Fig. 6: Peak forward voltage drop versus peak forward current (typical values).



1. ESD protection by the ESDAxxL

Electrostatic discharge (ESD) is a major cause of failure in electronic systems.

Transient Voltage Suppressors (TVS) are an ideal choice for ESD protection. They are capable of clamping the incoming transient to a low enough level such that damage to the protected semiconductor is prevented.

Surface mount TVS arrays offer the best choice for minimal lead inductance.

They serve as parallel protection elements, connected between the signal line to ground. As

the transient rises above the operating voltage of the device, the TVS array becomes a low impedance path diverting the transient current to ground.

The ESDAxxL array is the ideal board level protection of ESD sensitive semiconductor components.

The tiny SOT23 package allows design flexibility in the design of high density boards where the space saving is at a premium. This enables to shorten the routing and contributes to hardening against ESD.

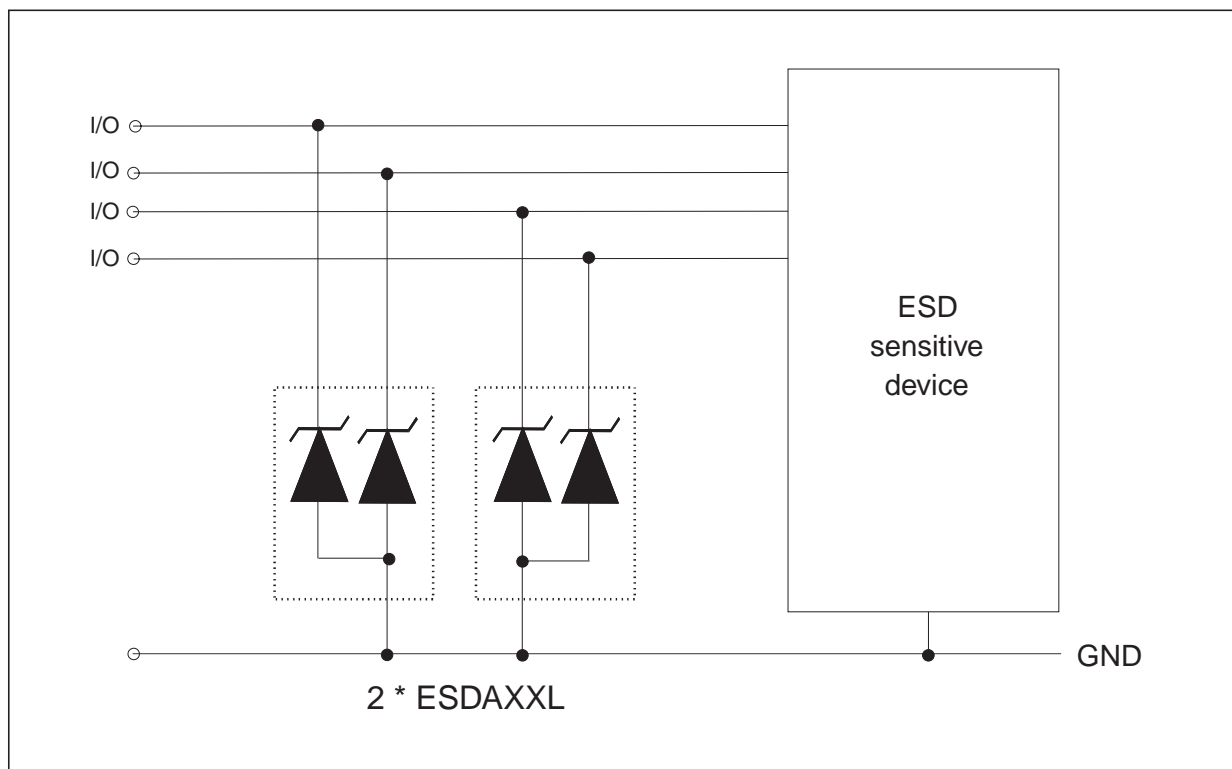

2. Circuit Board Layout

Circuit board layout is a critical design step in the suppression of ESD induced transients. The following guidelines are recommended :

- The ESDAxxL should be placed as close as possible to the input terminals or connectors.
- The path length between the ESD suppressor and the protected line should be minimized
- All conductive loops, including power and ground loops should be minimized
- The ESD transient return path to ground should be kept as short as possible.
- Ground planes should be used whenever possible.

ESDAxxL

ORDER CODE

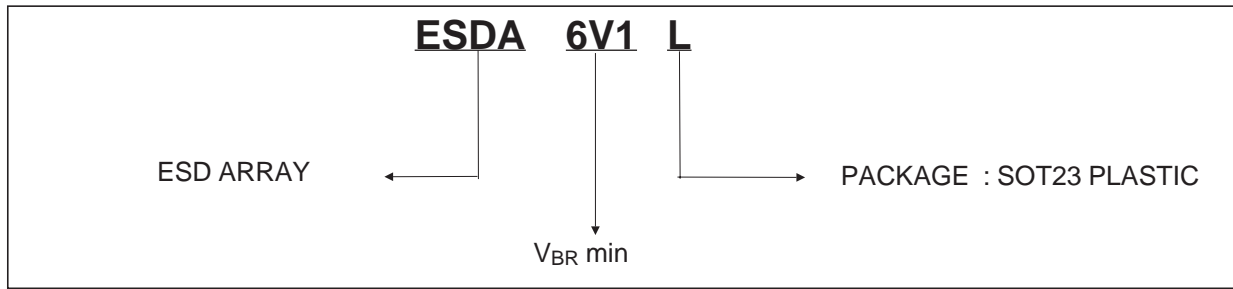

PACKAGE MECHANICAL DATA SOT23 (Plastic)

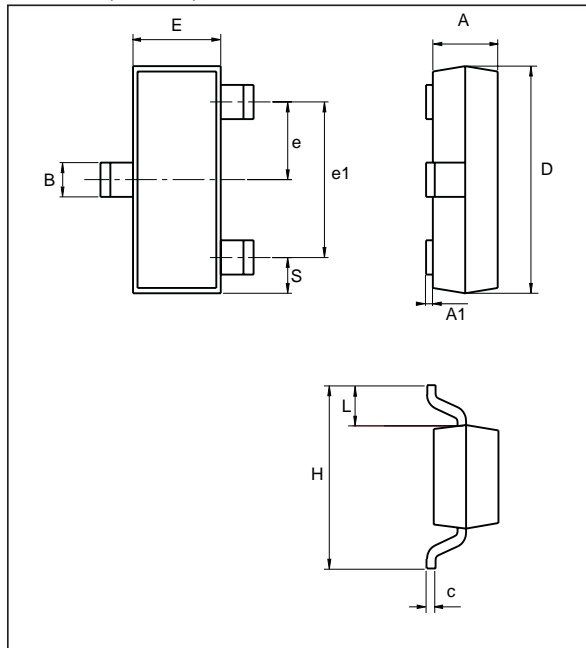

REF.	DIMENSIONS			
	Millimeters		Inches	
	Min.	Max.	Min.	Max.
A	0.89	1.4	0.035	0.055
A1	0	0.1	0	0.004
B	0.3	0.51	0.012	0.02
c	0.085	0.18	0.003	0.007
D	2.75	3.04	0.108	0.12
e	0.85	1.05	0.033	0.041
e1	1.7	2.1	0.067	0.083
E	1.2	1.6	0.047	0.063
H	2.1	2.75	0.083	0.108
L	0.6 typ.		0.024 typ.	
S	0.35	0.65	0.014	0.026

FOOT PRINT (in millimeters)

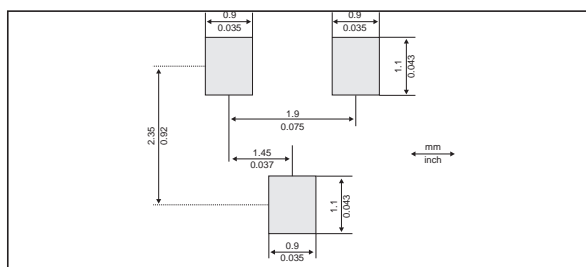

MARKING

TYPE	MARKING
ESDA5V3L	EL53
ESDA6V1L	EL61
ESDA14V2L	EL15
ESDA25L	EL25

Packaging: Standard packaging is tape and reel.

Information furnished is believed to be accurate and reliable. However, STMicroelectronics assumes no responsibility for the consequences of use of such information nor for any infringement of patents or other rights of third parties which may result from its use. No license is granted by implication or otherwise under any patent or patent rights of STMicroelectronics. Specifications mentioned in this publication are subject to change without notice. This publication supersedes and replaces all information previously supplied. STMicroelectronics products are not authorized for use as critical components in life support devices or systems without express written approval of STMicroelectronics.

The ST logo is a registered trademark of STMicroelectronics
© 2000 STMicroelectronics - Printed in Italy - All rights reserved.

STMicroelectronics GROUP OF COMPANIES
Australia - Brazil - China - Finland - France - Germany - Hong Kong - India - Italy - Japan - Malaysia
Malta - Morocco - Singapore - Spain - Sweden - Switzerland - United Kingdom - U.S.A.

<http://www.st.com>



Mouser Electronics

Authorized Distributor

Click to View Pricing, Inventory, Delivery & Lifecycle Information:

[STMicroelectronics:](#)

[ESDA5V3L](#) [ESDA6V1L](#) [ESDA14V2L](#) [ESDA25L](#)