

## Automotive dual-line Transil™, transient voltage suppressor (TVS) for CAN bus

Datasheet - production data

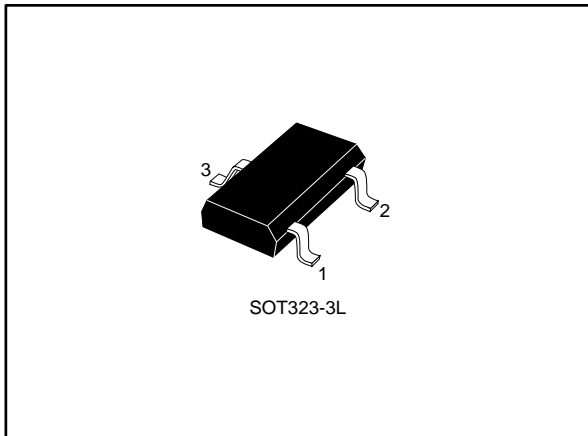

### Features

- Dual-line ESD and EOS protection
- Stand-off voltage:
  - ESDCAN02-2BWY: 26.5 V
  - ESDCAN03-2BWY: 24 V
- Bidirectional device
- Max pulse power: 250 W (8/20  $\mu$ s)
- Low clamping factor  $V_{CL} / V_{BR}$
- Low leakage current
- ECOPACK®2 compliant component
- AEC-Q101 qualified
- Complies with the following standards
  - ISO 10605 - C = 150 pF, R = 330  $\Omega$ :  $\pm$ 30 kV (air discharge) and  $\pm$ 30 kV (contact discharge)
  - ISO 10605 - C = 330 pF, R = 330  $\Omega$ :  $\pm$ 30 kV (air discharge) and  $\pm$ 30 kV (contact discharge)
  - ISO 7637-3: Pulse 3a:  $V_s = -150$  V and Pulse 3b:  $V_s = +100$  V

### Applications

Automotive controller area network (CAN) bus lines where electrostatic discharge and other transients must be suppressed. This product is compliant with most of automotive interfaces.

### Description

The ESDCAN02-2BWY and ESDCAN03-2BWY are a dual-line Transil specifically designed for the protection of the automotive CAN bus lines against electrostatic discharge (ESD).

the market make it compliant with all key interfaces in automotive: CAN-FD, LIN, FlexRay, MOST, SENT, etc.

Table 1: Device summary

Order code	$V_{RM}$	Package
ESDCAN02-2BWY	26.5 V	SOT323-3L
ESDCAN03-2BWY	24 V	

Figure 1: Functional diagram

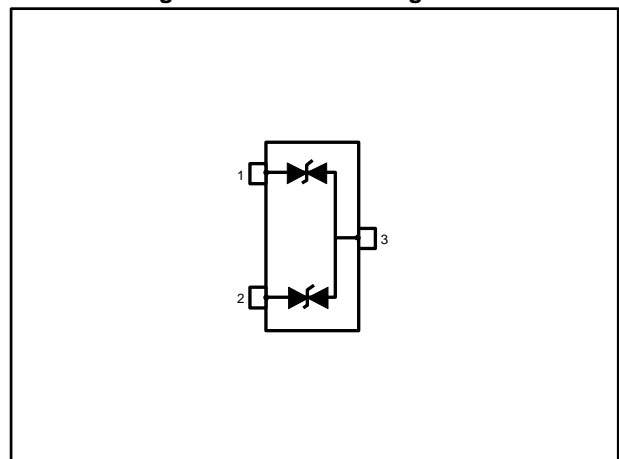

# 1 Characteristics

**Table 2: Absolute ratings (Tamb = 25 °C)**

Symbol	Parameter		Value	Unit
V <sub>PP</sub>	Electrostatic discharge capability	ISO 10605 - C = 150 pF, R = 330 Ω:	30	kV
		Contact discharge	30	
		Air discharge		
		ISO 10605 - C = 330 pF, R = 330 Ω:	30	
		Contact discharge	30	
		Air discharge		
		HBM MIL STD 883	30	
P <sub>PP</sub>	Peak pulse power dissipation (8/20 μs)	T <sub>jinitial</sub> = T <sub>amb</sub>	250	W
I <sub>PP</sub>	Peak pulse current (8/20 μs)		3.7	A
T <sub>j</sub>	Operating junction temperature range		-55 to +175	°C
T <sub>stg</sub>	Storage temperature range		-55 to +175	°C

**Figure 2: Electrical characteristics (definitions)**

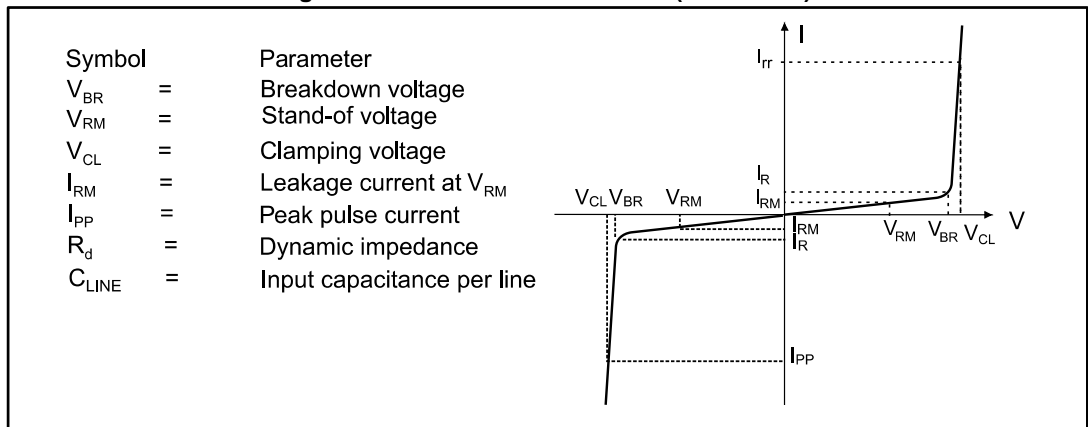

Table 3: Electrical characteristics (Tamb = 25 °C)

Symbol	Test condition	Min.	Typ.	Max.	Unit
V <sub>RM</sub>	ESDCAN02-2BWY			26.5	V
	ESDCAN03-2BWY			24	
V <sub>BR</sub>	I <sub>R</sub> = 1 mA, ESDCAN02-2BWY	28.5			V
	I <sub>R</sub> = 1 mA, ESDCAN03-2BWY	26.5			
I <sub>RM</sub>	V <sub>RM</sub> = 24 V	T <sub>jinitial</sub> = 25 °C		10	nA
	V <sub>RM</sub> = 5 V			1	
	V <sub>RM</sub> = 24 V	T <sub>jinitial</sub> = 125 °C		50	
	V <sub>RM</sub> = 5 V			10	
V <sub>CL</sub>	ISO 7637-3 Pulse 3a (U <sub>S</sub> = -150 V)	ESDCAN02-2BWY		-39	V
	ISO 7637-3 Pulse 3b (U <sub>S</sub> = +100 V)			39	
	IEC 61000-4-5 (8/20 μs), I <sub>PP</sub> = 1 A			37	
	IEC 61000-4-5 (8/20 μs), I <sub>PP</sub> = 3 A			44	
V <sub>CL</sub>	ISO 7637-3 Pulse 3a (U <sub>S</sub> = -150 V)	ESDCAN03-2BWY		-37	V
	ISO 7637-3 Pulse 3b (U <sub>S</sub> = +100 V)			37	
	IEC 61000-4-5 (8/20 μs), I <sub>PP</sub> = 1 A			35	
	IEC 61000-4-5 (8/20 μs), I <sub>PP</sub> = 3 A			41	
C	F = 1 MHz, V <sub>R</sub> = 0 V DC		3	3.5	pF
ΔC	Capacitance difference between both line versus ground		0.01	0.08	pF
αT <sup>(1)</sup>	Voltage temperature coefficient			9	10 <sup>-4</sup> /°C

**Notes:**

<sup>(1)</sup>V<sub>BR</sub> at T<sub>j</sub> = V<sub>BR</sub> at 25 °C x (1 + αT x (T<sub>j</sub> - 25))

## 1.2 Characteristics (curves)

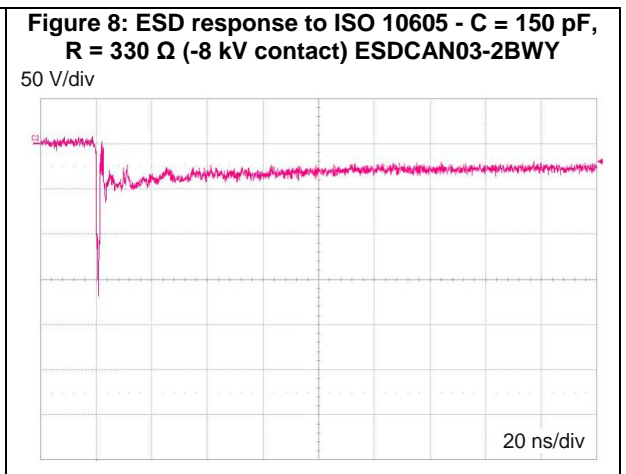
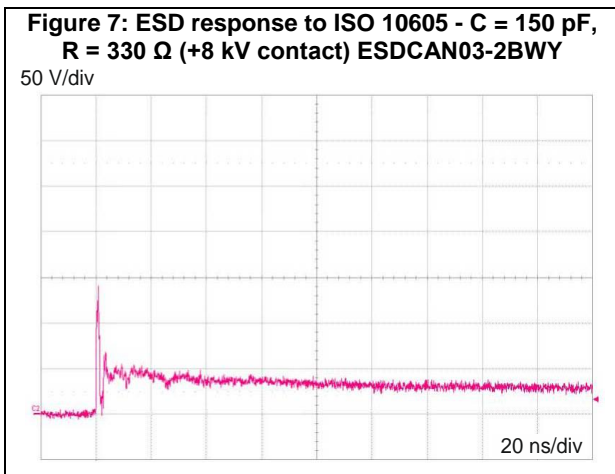
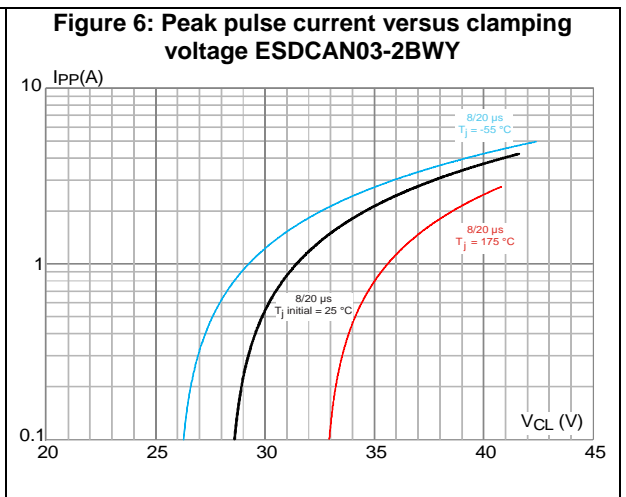
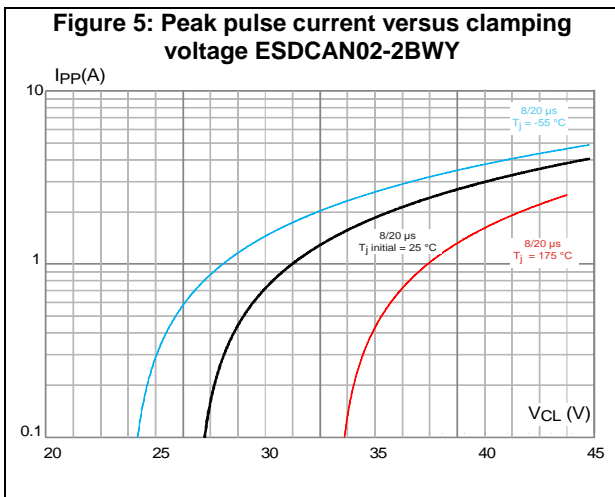
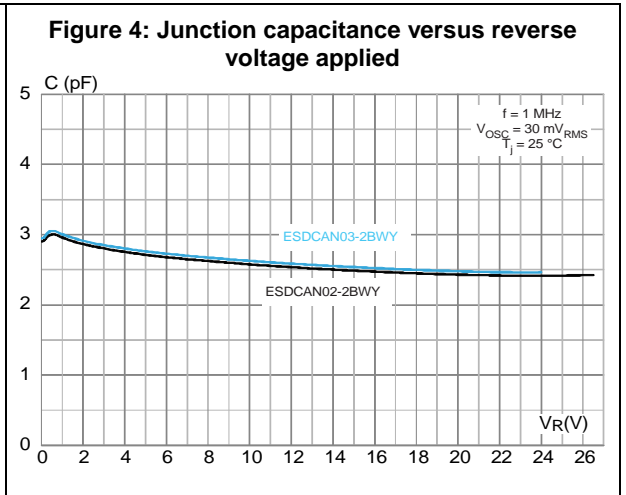
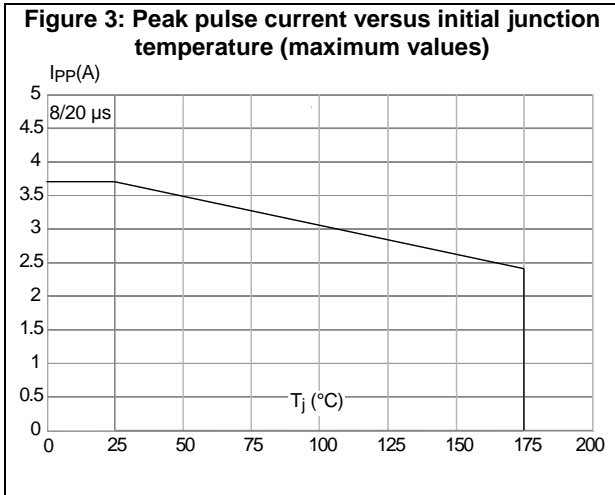

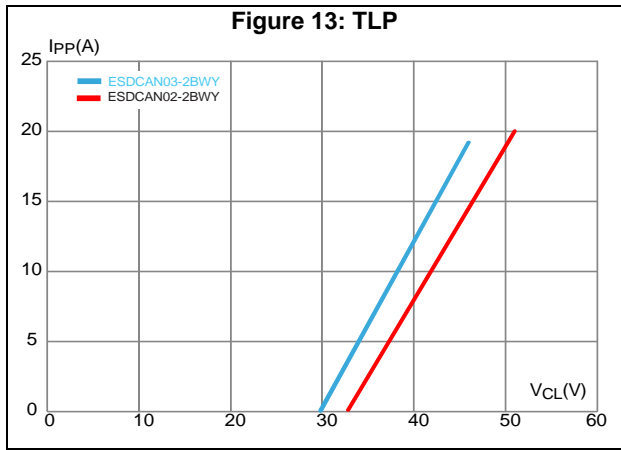
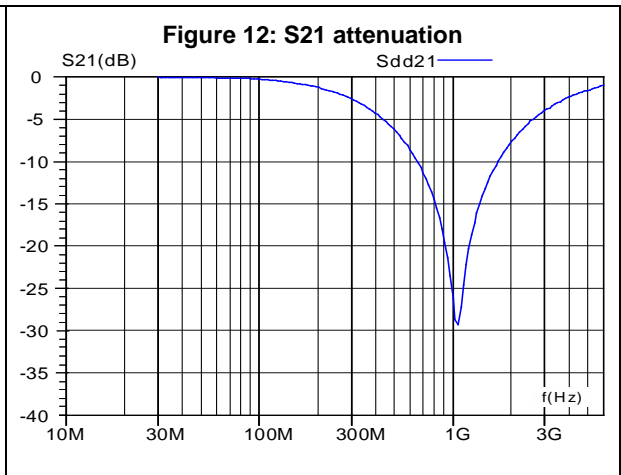
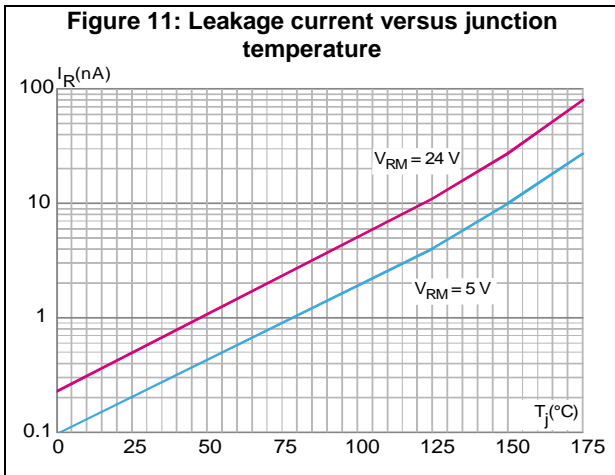
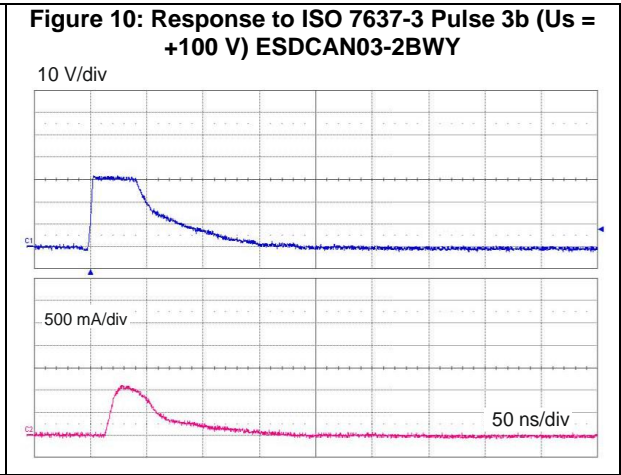
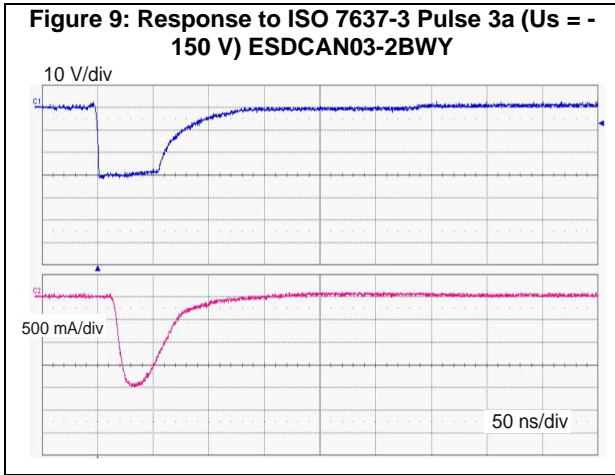

## 2 Package information

In order to meet environmental requirements, ST offers these devices in different grades of ECOPACK® packages, depending on their level of environmental compliance. ECOPACK® specifications, grade definitions and product status are available at: [www.st.com](http://www.st.com). ECOPACK® is an ST trademark.

- Epoxy meets UL 94,V0
- Lead-free package

### 2.1 SOT323-3L package information

Figure 14: SOT323-3L package outline

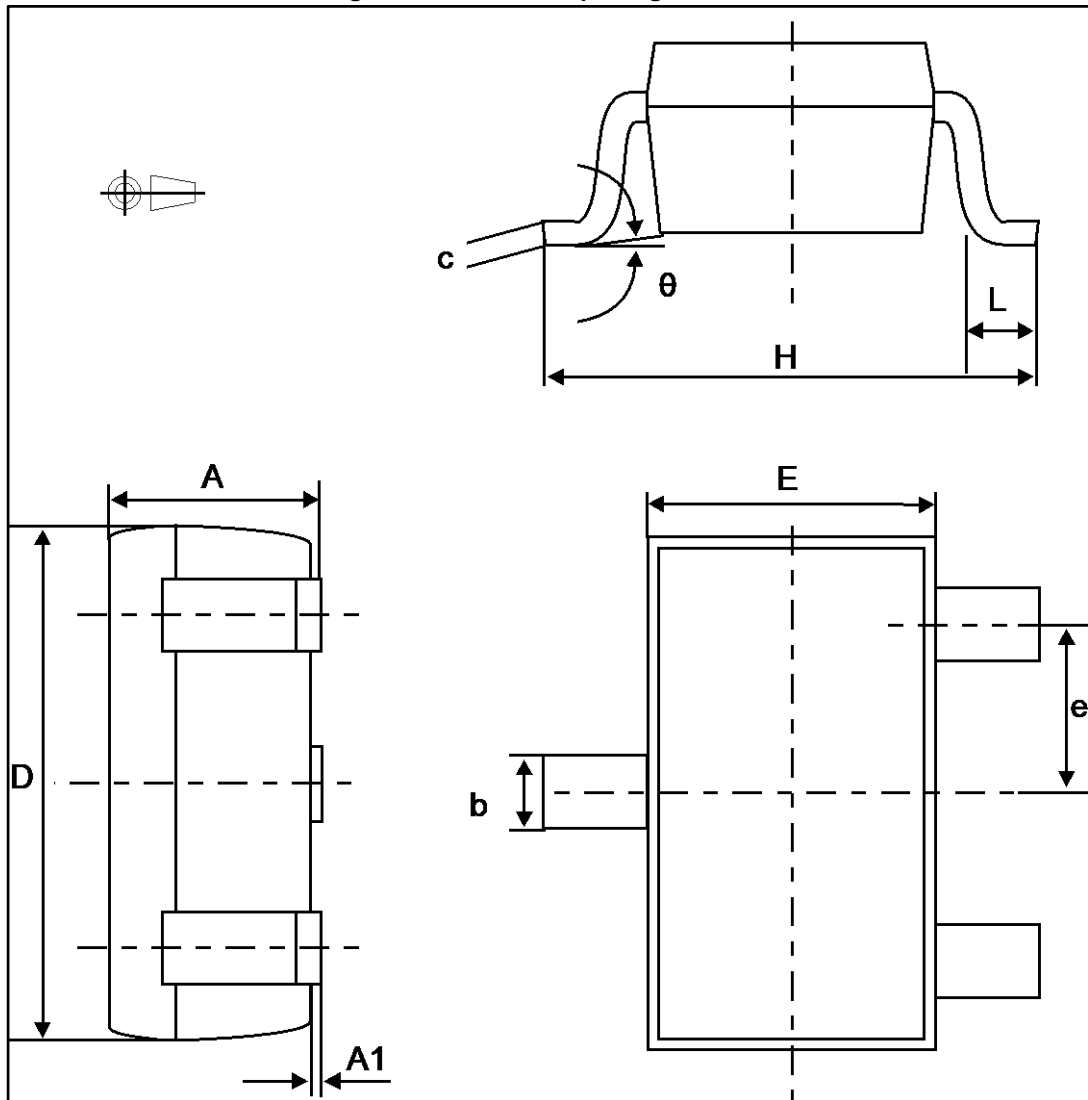
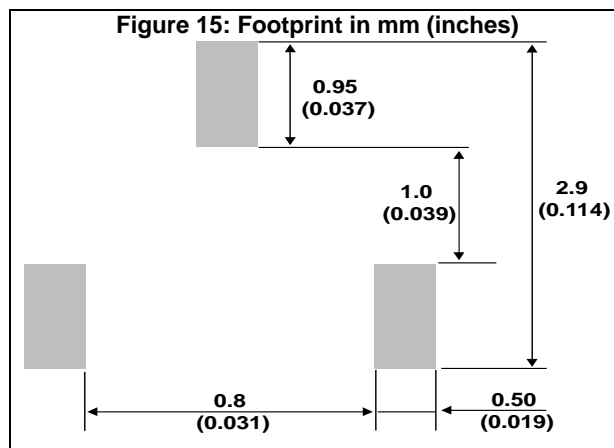

Table 4: SOT323-3L package mechanical data

Ref.	Dimensions					
	Millimeters			Inches <sup>(1)</sup>		
	Min.	Typ.	Max.	Min.	Typ.	Max.
A		0.8	1.1		0.031	0.043
A1		0.0	0.1		0.000	0.003
b		0.25	0.4		0.0098	0.0157
c		0.1	0.26		0.003	0.0102
D	2.0	1.8	2.2	0.078	0.070	0.086
E	1.25	1.15	1.35	0.0492	0.0452	0.0531
e	0.65			0.0255		
H	2.1	1.8	2.4	0.082	0.070	0.094
L	0.2	0.1	0.3	0.007	0.003	0.011
Θ		0	30°		0	30°

**Notes:**

<sup>(1)</sup>Values in inches are converted from mm and rounded to 4 decimal digits.



### 3 Recommendation on PCB assembly

#### 3.1 PCB design preference

1. To control the solder paste amount, the closed via is recommended instead of open vias.
2. The position of tracks and open vias in the solder area should be well balanced. A symmetrical layout is recommended, to avoid any tilt phenomena caused by asymmetrical solder paste due to solder flow away.

#### 3.2 Reflow profile

Figure 16: ST ECOPACK® recommended soldering reflow profile for PCB mounting

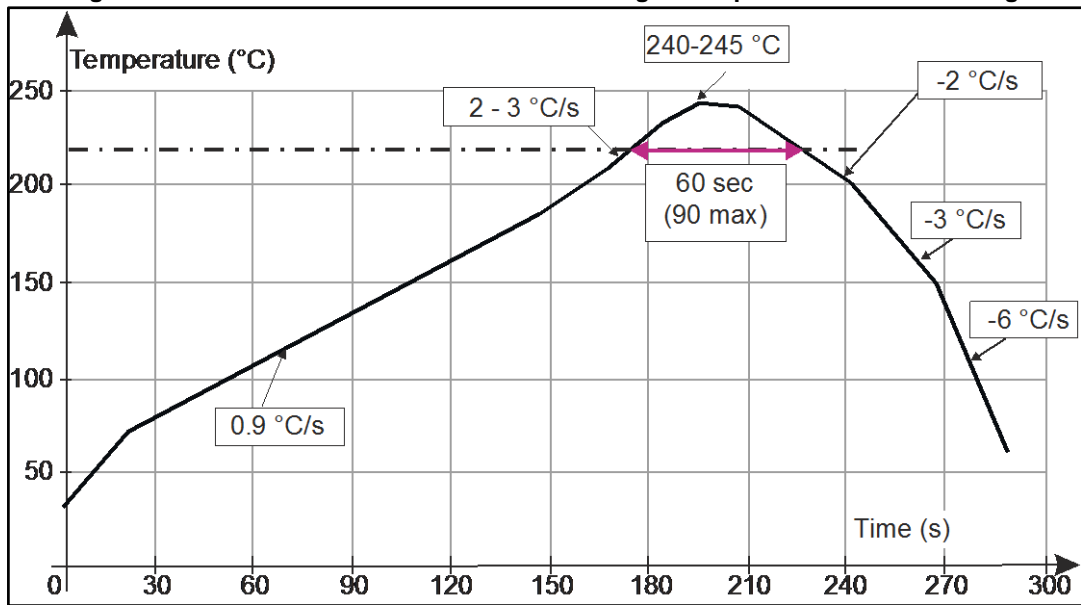

Minimize air convection currents in the reflow oven to avoid component movement. Maximum soldering profile corresponds to the latest IPC/JEDEC J-STD-020.



## 4 Ordering information

Figure 17: Ordering information scheme

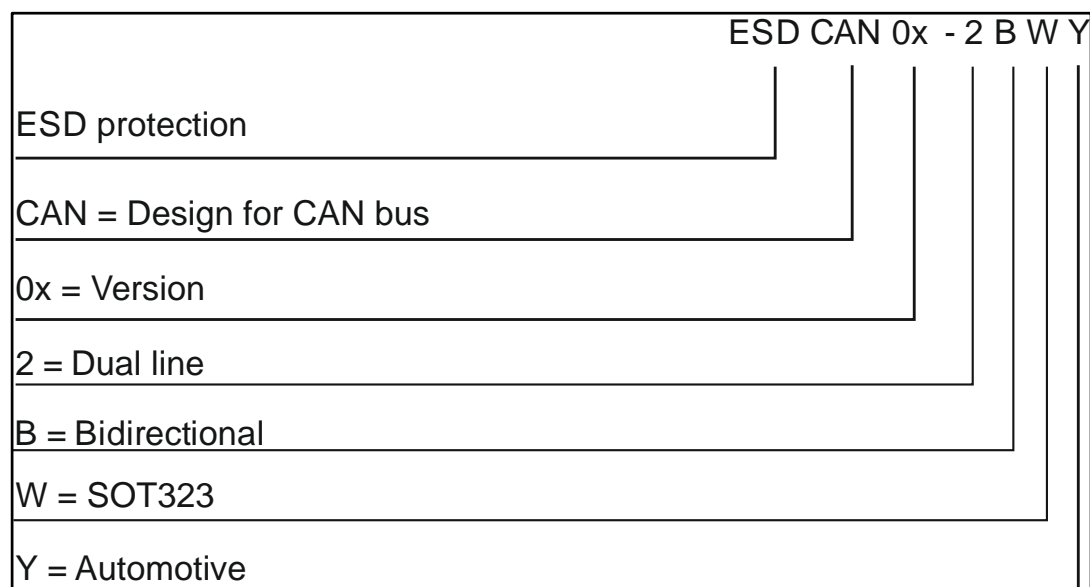

Table 5: Ordering information

Order code	Marking <sup>(1)</sup>	Package	Weight	Base qty.	Delivery mode
ESDCAN02-2BWY	C02	SOT323-3L	6.58 mg	3000	Tape and reel
ESDCAN03-2BWY	C03	SOT323-3L	6.58 mg	3000	Tape and reel

**Notes:**

<sup>(1)</sup>The marking can be rotated by multiples of 90° to differentiate assembly location

## 5 Revision history

Table 6: Document revision history

Date	Revision	Changes
11-Apr-2015	1	First issue.
30-Sep-2015	2	Updated <i>Figure 3: "Peak pulse current versus initial junction temperature (maximum values)"</i> .
16-Jun-2016	3	Updated <i>Figure 5: "Peak pulse current versus clamping voltage ESDCAN02-2BWY"</i> and <i>Figure 6: "Peak pulse current versus clamping voltage ESDCAN03-2BWY"</i> .

**IMPORTANT NOTICE – PLEASE READ CAREFULLY**

STMicroelectronics NV and its subsidiaries ("ST") reserve the right to make changes, corrections, enhancements, modifications, and improvements to ST products and/or to this document at any time without notice. Purchasers should obtain the latest relevant information on ST products before placing orders. ST products are sold pursuant to ST's terms and conditions of sale in place at the time of order acknowledgement.

Purchasers are solely responsible for the choice, selection, and use of ST products and ST assumes no liability for application assistance or the design of Purchasers' products.

No license, express or implied, to any intellectual property right is granted by ST herein.

Resale of ST products with provisions different from the information set forth herein shall void any warranty granted by ST for such product.

ST and the ST logo are trademarks of ST. All other product or service names are the property of their respective owners.

Information in this document supersedes and replaces information previously supplied in any prior versions of this document.

© 2016 STMicroelectronics – All rights reserved

# Mouser Electronics

Authorized Distributor

Click to View Pricing, Inventory, Delivery & Lifecycle Information:

[STMicroelectronics:](#)

[ESDCAN03-2BWY](#) [ESDCAN02-2BWY](#)