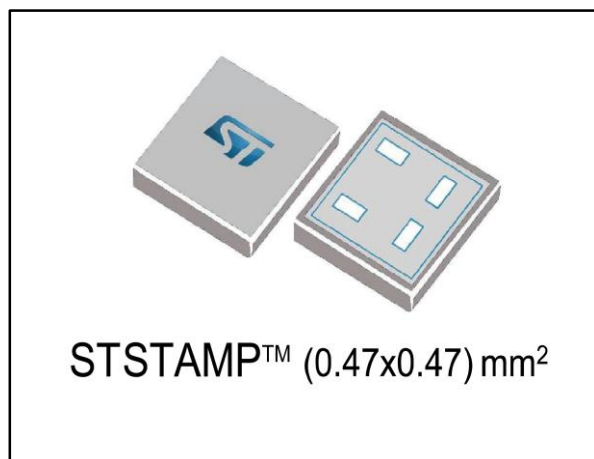

**200 mA very low quiescent current linear regulator IC in
(0.47x0.47) mm² STSTAMP™ package**

Datasheet - production data

**Features**

- Input voltage from 1.5 to 5.5 V
- Ultra low-dropout voltage (200 mV typ. at 200 mA load)
- Very low quiescent current (20 μ A typ. at no-load, 0.03 μ A typ. in off mode)
- Output voltage tolerance: $\pm 1.5\%$ @ 25 °C
- 200 mA guaranteed output current
- High PSRR (80 dB@1 kHz, 50 db@100 kHz)
- Wide range of output voltages available on request: from 0.8 V up to 5.0 V in 50 mV step
- Logic-controlled electronic shutdown
- Internal soft-start
- Optional output voltage discharge feature
- Compatible with ceramic capacitor
 $C_{OUT} = 0.47 \mu F$

- Internal constant current and thermal protections
- Available in STSTAMP™ (0.47x0.47) mm² package
- Operating temperature range: -40 °C to 125 °C

Application

- Mobile phones
- Tablet
- Digital still cameras (DSC)
- Wearable devices
- Portable media players

Description

The LDBL20 high accuracy voltage regulator provides 200 mA of maximum current from an input voltage ranging from 1.5 V to 5.5 V, with a typical dropout voltage of 200 mV.

It is available in the new STSTAMP™ package, allowing the maximum space saving.

The device is stabilized with a ceramic capacitor on the output. The ultra low drop voltage, low quiescent current and low noise features, together with the internal soft-start circuit, make the LDBL20 suitable for low power battery-operated applications.

An enable logic control function puts the LDBL20 in shutdown mode with a total current consumption lower than 0.2 μ A. Constant current and thermal protection are provided.

Contents

1	Diagram	3
2	Pin configuration	4
3	Typical application	5
4	Maximum ratings	6
5	Electrical characteristics	7
6	Application information	9
	6.1 Soft-start function	9
	6.2 Output discharge function	9
	6.3 Input output capacitors.....	9
7	Typical characteristics	10
8	Package information	14
	8.1 STSTAMP™ (0.47x0.47) mm ² package information	15
9	Ordering information	17
10	Revision history	18

1 Diagram

Figure 1: Block diagram

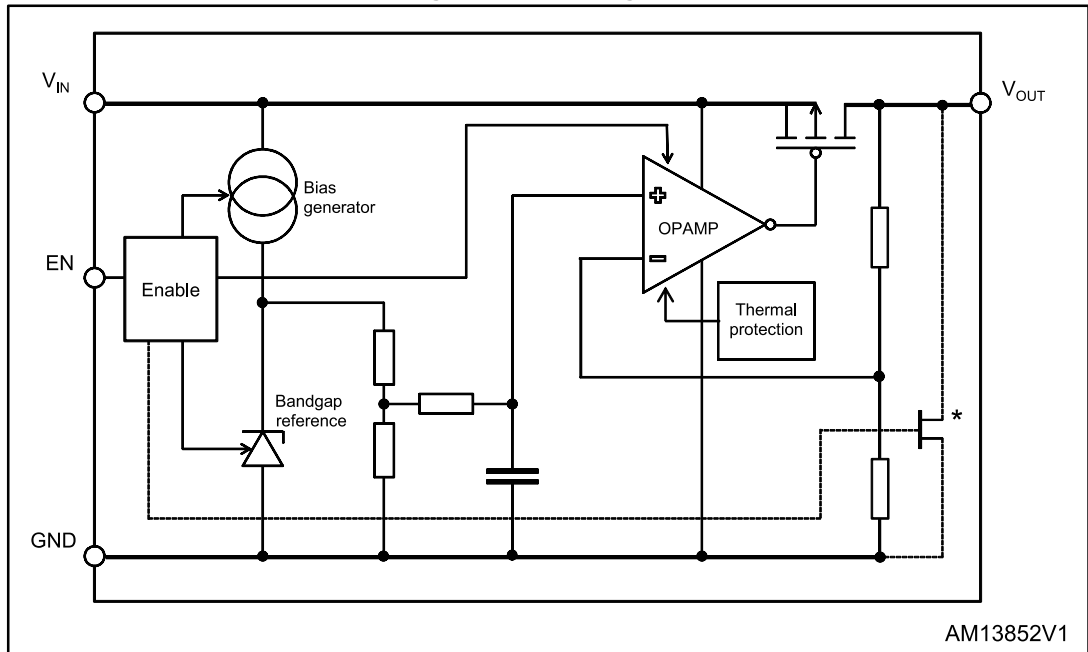

AM13852V1



The output discharge MOSFET is optional.

2 Pin configuration

Figure 2: Pin connection

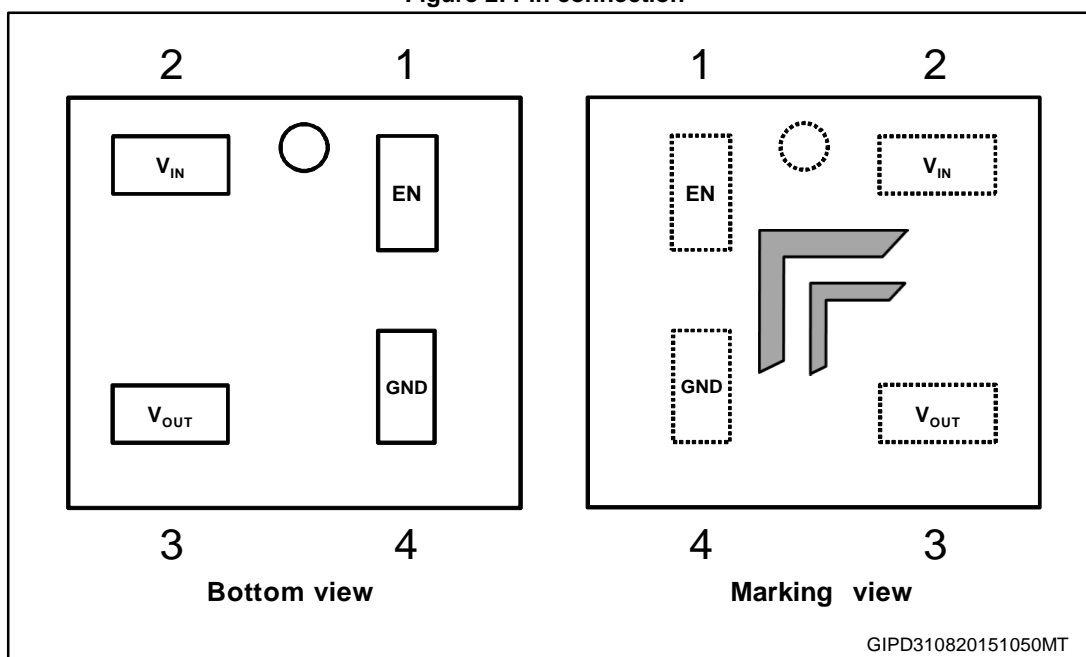
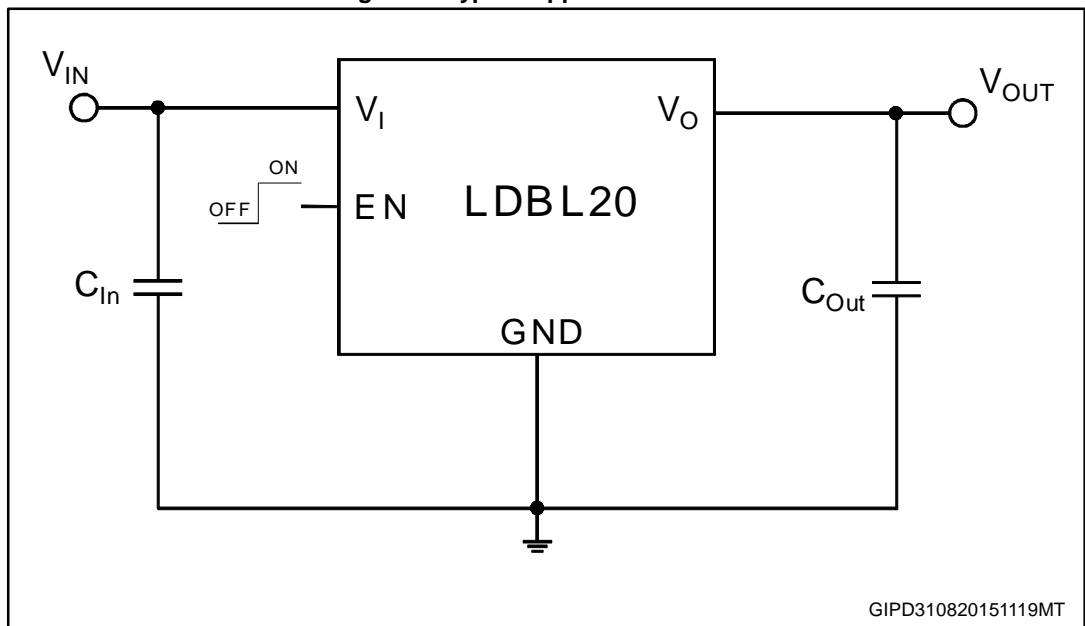

Table 1: Pin description

Pin	Symbol	Function
3	OUT	Output voltage
4	GND	Common ground
1	EN	Enable pin logic input: low = shutdown, high = active
2	IN	Input voltage

3 Typical application

Figure 3: Typical application circuits



4 Maximum ratings

Table 2: Absolute maximum ratings

Symbol	Parameter	Value	Unit
V_{IN}	Input voltage	- 0.3 to 7	V
V_{OUT}	Output voltage	- 0.3 to $V_{IN} + 0.3$	V
V_{EN}	Enable input voltage	- 0.3 to 7	V
I_{OUT}	Output current	Internally limited	mA
P_D	Power dissipation	Internally limited	mW
T_{STG}	Storage temperature range	- 40 to 150	°C
T_{OP}	Operating junction temperature range	- 40 to 125	°C



Absolute maximum ratings are those values beyond which damage to the device may occur. Functional operation under these conditions is not implied. All values are referred to GND.

Table 3: ESD performance

Symbol	Parameter	Test conditions	Value	Unit
ESD	ESD protection voltage	HBM	4	kV
		MM	400	V
		CDM	500	V

5 Electrical characteristics

$T_J = 25\text{ }^\circ\text{C}$, $V_{IN} = V_{OUT(NOM)} + 1\text{ V}$ or 1.5 V , whichever is greater, $C_{IN} = C_{OUT} = 1\text{ }\mu\text{F}$, $I_{OUT} = 1\text{ mA}$, $V_{EN} = V_{IN}$, unless otherwise specified.

Table 4: LDBL20 electrical characteristics

Symbol	Parameter	Test conditions	Min.	Typ.	Max.	Unit
V_{IN}	Operating input voltage		1.5		5.5	V
V_{OUT}	V_{OUT} accuracy	$I_{OUT} = 1\text{ mA}$, $T_J = 25\text{ }^\circ\text{C}$	-1.5		+1.5	%
		$I_{OUT} = 1\text{ mA}$, $-40\text{ }^\circ\text{C} < T_J < 125\text{ }^\circ\text{C}$	-3		+3	%
ΔV_{OUT}	Static line regulation ⁽¹⁾	$V_{OUT(NOM)} + 1\text{ V} \leq V_{IN} \leq 5.5\text{ V}$, $I_{OUT} = 10\text{ mA}$		0.02		%V
		$-40\text{ }^\circ\text{C} < T_J < 125\text{ }^\circ\text{C}$			0.2	
ΔV_{OUT}	Static load regulation	$I_{OUT} = 0\text{ mA}$ to 200 mA		10		mV
		$-40\text{ }^\circ\text{C} < T_J < 125\text{ }^\circ\text{C}$			0.01	%/mA
V_{DROP}	Dropout voltage	$I_{OUT} = 30\text{ mA}$, $V_{OUT} = 2.8\text{ V}$		35		mV
		$I_{OUT} = 200\text{ mA}$, $V_{OUT} = 2.8\text{ V}$, $-40\text{ }^\circ\text{C} < T_J < 125\text{ }^\circ\text{C}$		200	350	
e_N	Output noise voltage	10 Hz to 100 kHz, $I_{OUT} = 10\text{ mA}$		45		μV_{RMS}
SVR	Supply voltage rejection	$V_{IN} = V_{OUT(NOM)} + 1\text{ V} \pm V_{RIPPLE}$ $V_{RIPPLE} = 0.2\text{ V}$ Frequency = 1 kHz $I_{OUT} = 30\text{ mA}$		80		dB
		$V_{IN} = V_{OUT(NOM)} + 1\text{ V} \pm V_{RIPPLE}$ $V_{RIPPLE} = 0.2\text{ V}$ Frequency = 100 kHz $I_{OUT} = 30\text{ mA}$		55		
I_Q	Quiescent current	$I_{OUT} = 0\text{ mA}$		20	40	μA
		$I_{OUT} = 200\text{ mA}$		100		
$I_{Standby}$	Standby current	V_{IN} input current in OFF mode: $V_{EN} = \text{GND}$		0.03	0.2	μA
I_{SC}	Short-circuit current	$R_L = 0$	250	350		mA
R_{ON}	Output voltage discharge MOSFET	(LD39020DT only)		100		Ω
V_{EN}	Enable input logic low	$V_{IN} = 1.5\text{ V}$ to 5.5 V $-40\text{ }^\circ\text{C} < T_J < 125\text{ }^\circ\text{C}$			0.4	V
	Enable input logic high	$V_{IN} = 1.5\text{ V}$ to 5.5 V $-40\text{ }^\circ\text{C} < T_J < 125\text{ }^\circ\text{C}$	1			
I_{EN}	Enable pin input current	$V_{EN} = V_{IN}$			100	nA
$T_{ON}^{(2)}$	Turn-on time			100		μs

Symbol	Parameter	Test conditions	Min.	Typ.	Max.	Unit
T _{SHDN}	Thermal shutdown			160		°C
	Hysteresis			20		
C _{OUT}	Output capacitor	Capacitance	0.47		22	μF

Notes:

(1)Not applicable for V_{out}(nom) > 4.5 V

(2)Turn-on time is time measured between the enable input just exceeding V_{EN} high value and the output voltage just reaching 95 % of its nominal value

6 Application information

6.1 Soft-start function

The LDBL20 has an internal soft-start circuit. By increasing the startup time up to 100 μs , without the need of any external soft-start capacitor, this feature keeps the regulator inrush current at startup under control.

6.2 Output discharge function

The LDBL20 integrates a MOSFET connected between V_{OUT} and GND. This transistor is activated when the EN pin goes to low logic level and has the function to quickly discharge the output capacitor when the device is disabled by the user.

The device is available with or without the auto-discharge feature. See [Table 6: "Order code"](#).

6.3 Input output capacitors

The LDBL20 requires external capacitors to assure the regulator control loop stability.

Any good quality ceramic capacitor can be used but, the X5R and the X7R are suggested since they guarantee a very stable combination of capacitance and ESR overtemperature.

Locating the input/output capacitors as closer as possible to the relative pins is recommended.

The LDBL20 requires an input capacitor with a minimum value of 1 μF .

This capacitor must be located as closer as possible to the input pin of the device and returned to a clean analog ground.

The control loop of the LDBL20 is designed to work with an output ceramic capacitor.

This capacitor must meet the requirements of minimum capacitance and equivalent series resistance (ESR), as shown in [Figure 17: "Stability area vs \(C_{OUT}, ESR\)"](#). To assure stability, the output capacitor must maintain its ESR and capacitance in the stable region, over the full operating temperature range.

The LDBL20 shows stability with a minimum effective output capacitance of 220 nF.

However, to keep stability in all operating conditions (temperature, input voltage and load variations), a minimum output capacitor of 0.47 μF is recommended.

The suggested combination of 1 μF input and output capacitors offers a good compromise among the stability of the regulator, optimum transient response and total PCB area occupation.

7 Typical characteristics

($C_{IN} = C_{OUT} = 1 \mu F$, V_{EN} to V_{IN} , $T_J = 25 \text{ }^\circ\text{C}$ unless otherwise specified)

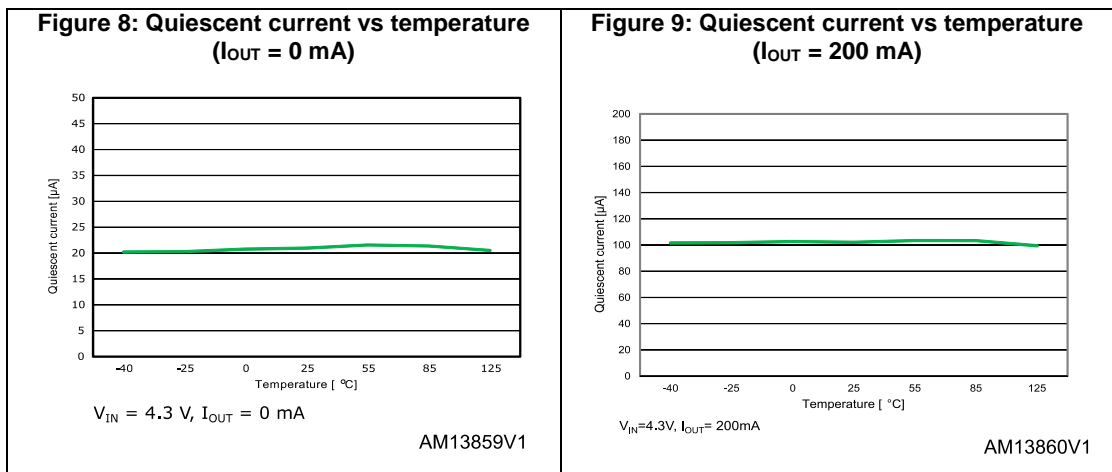
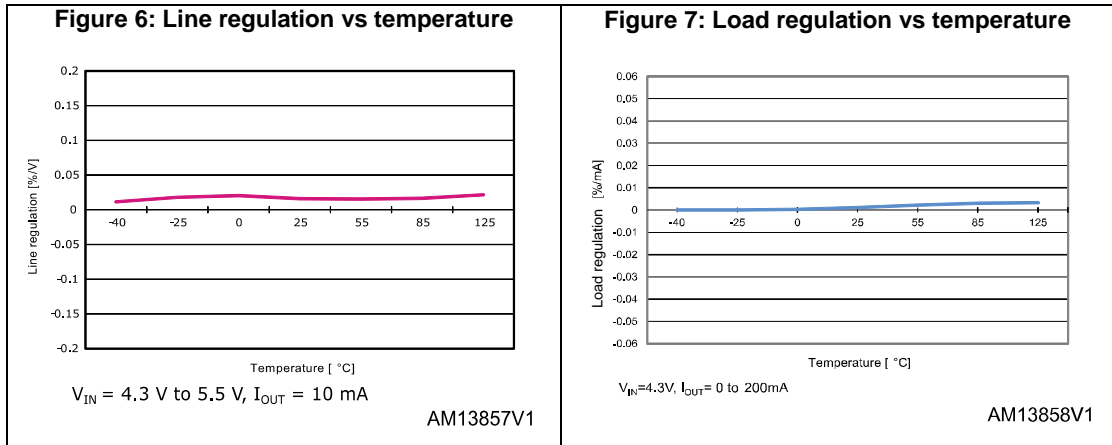
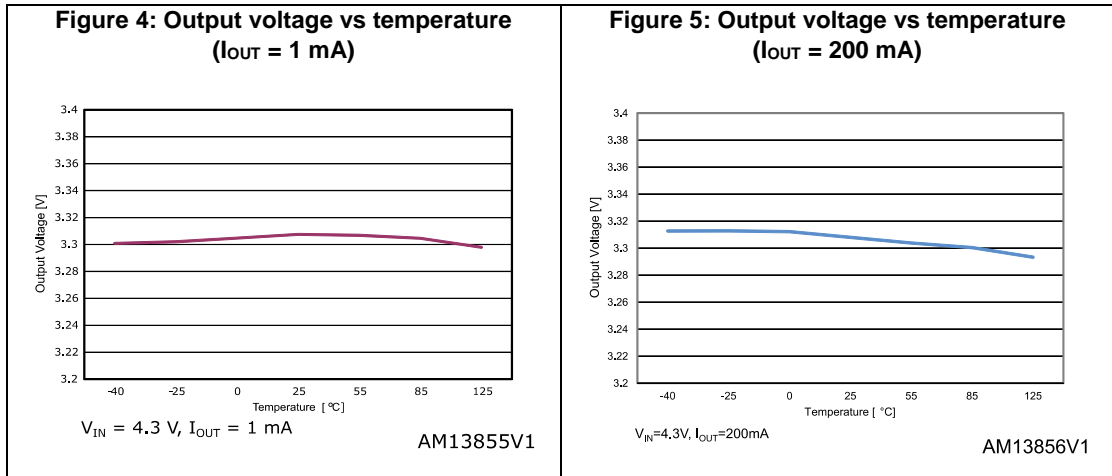
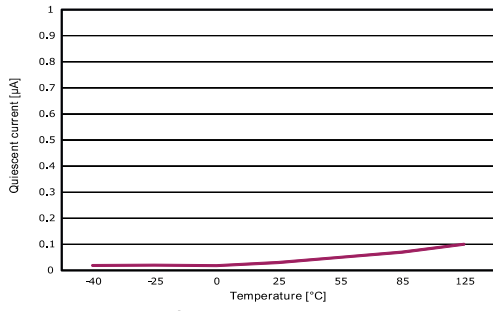

Figure 10: Shutdown current vs temperature



$V_{IN} = V, V_{EN} = GND$

AM13861V1

Figure 11: Quiescent current vs load current

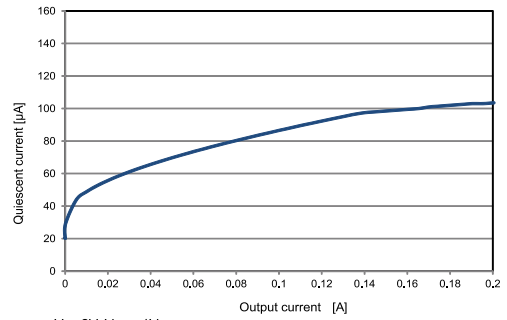

$V_{IN}=2V, V_{OUT}=1V$

AM13862V1

Figure 12: Quiescent current vs input voltage

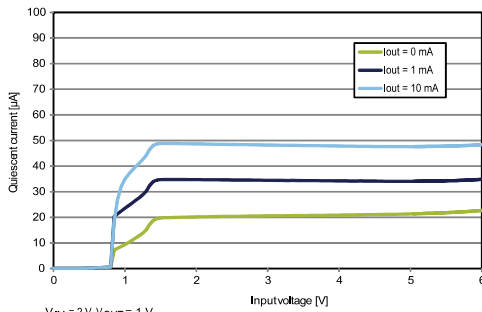

$V_{IN} = 2V, V_{OUT} = 1V$

AM13863V1

Figure 13: Dropout voltage vs temperature

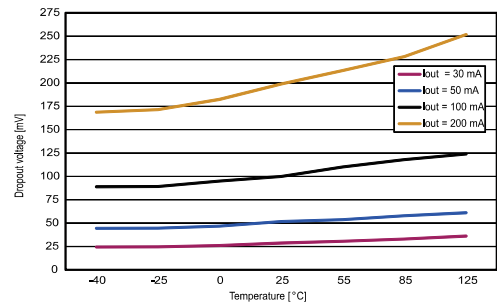

AM13864V1

Figure 14: Supply voltage rejection vs frequency

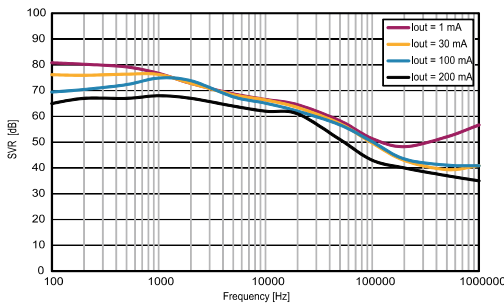

$V_{IN} 2V \pm 200mV, V_{OUT} = 1V, C_{OUT} = 1\mu F$

AM13865V1

Figure 15: Supply voltage rejection vs input voltage

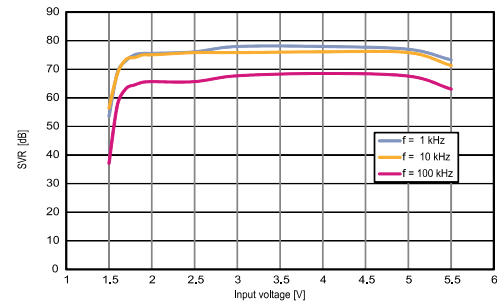

$I_{OUT} = 30mA, V_{OUT} = 1V, C_{OUT} = 1\mu F$

AM13866V1

Figure 16: Output noise spectral density

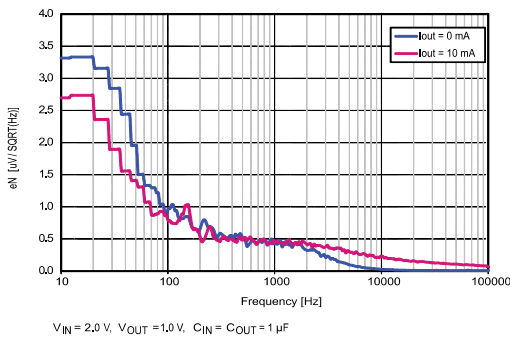

Figure 17: Stability area vs (C_{OUT} , ESR)

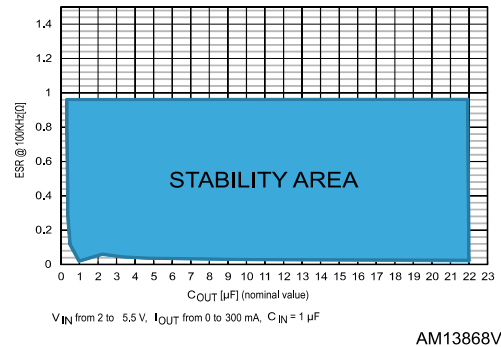

Figure 18: Enable startup ($V_{OUT} = 1\text{ V}$)

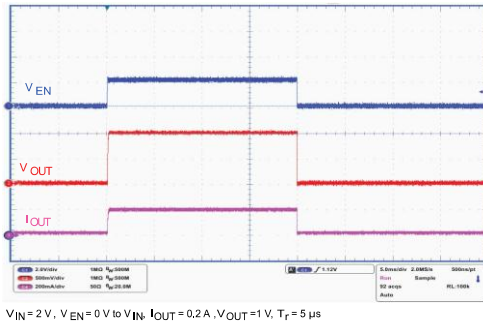

Figure 19: Enable startup ($V_{OUT} = 5\text{ V}$)

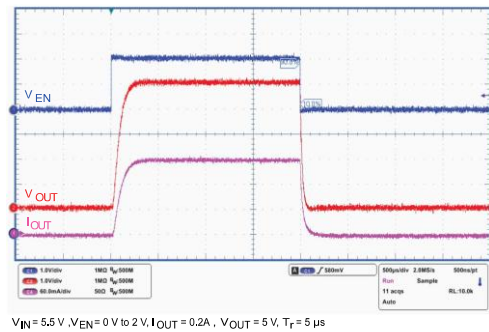

Figure 20: Turn-on time ($V_{OUT} = 1\text{ V}$)

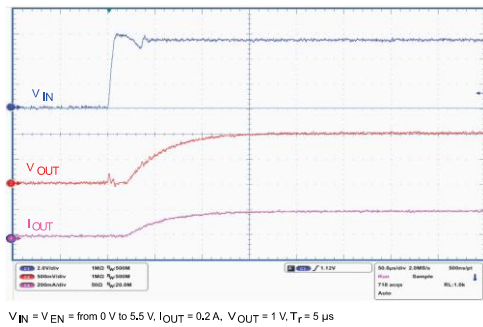

Figure 21: Turn-off time ($V_{OUT} = 1\text{ V}$)

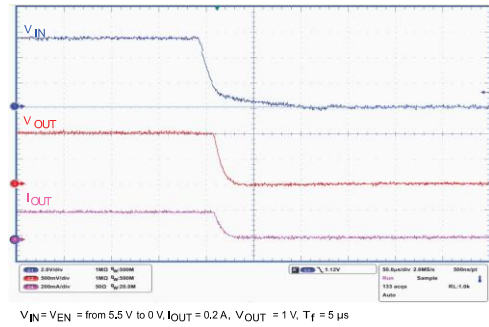
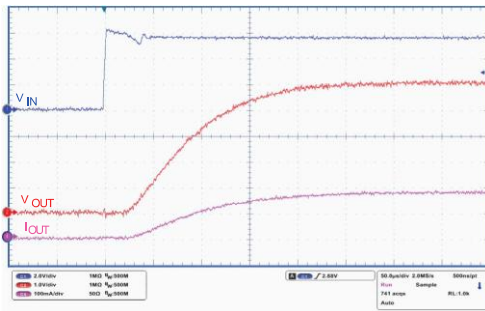

Figure 22: Turn-on time ($V_{OUT} = 5\text{ V}$)



$V_{IN} = V_{EN}$ = from 0 V to 5.5 V, $I_{OUT} = 0.2\text{ A}$, $V_{OUT} = 5\text{ V}$, $T_r = 5\text{ }\mu\text{s}$

AM13873V1

Figure 23: Turn-off time ($V_{OUT} = 5\text{ V}$)

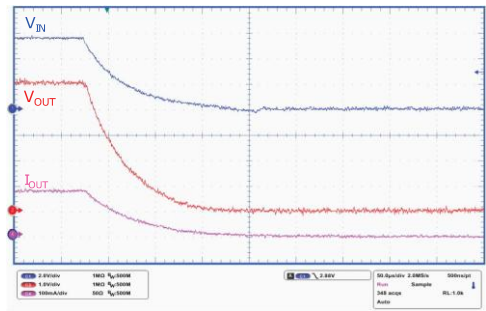

$V_{IN} = V_{EN}$ = from 5.5 V to 0 V, $I_{OUT} = 0.2\text{ A}$, $V_{OUT} = 5\text{ V}$, $T_f = 5\text{ }\mu\text{s}$

AM13874V1

Figure 24: Line transient ($V_{OUT} = 1\text{ V}$)

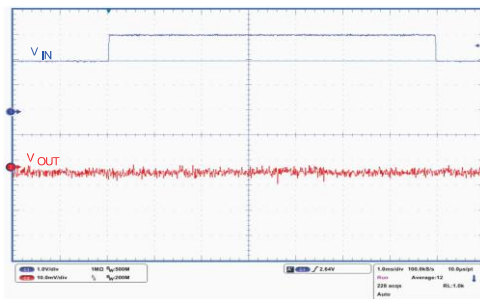

$V_{IN} = V_{EN}$ = from 2 V to 3 V, $I_{OUT} = 10\text{ mA}$, $V_{OUT} = 1\text{ V}$, $T_r = T_f = 5\text{ }\mu\text{s}$

AM13875V1

Figure 25: Line transient ($V_{OUT} = 5\text{ V}$)

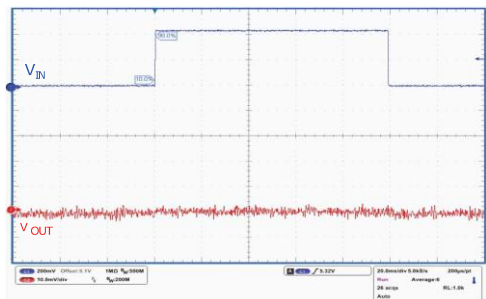

$V_{IN} = V_{EN}$ = from 5.1 V to 5.5 V, $I_{OUT} = 10\text{ mA}$, $V_{OUT} = 5\text{ V}$, $T_r = T_f = 5\text{ }\mu\text{s}$

AM13876V1

Figure 26: Load transient ($V_{OUT} = 1\text{ V}$)

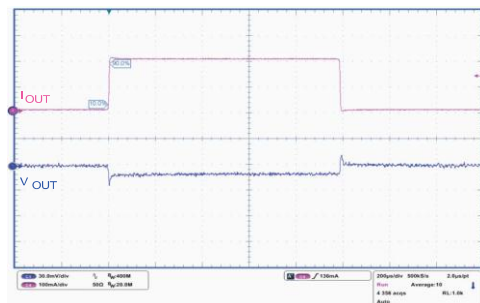

$V_{IN} = V_{EN} = 2\text{ V}$, I_{OUT} = from 0 to 0.2 A, $V_{OUT} = 1\text{ V}$, $t_r = t_f = 5\text{ }\mu\text{s}$

AM13877V1

Figure 27: Load transient ($V_{OUT} = 5\text{ V}$)

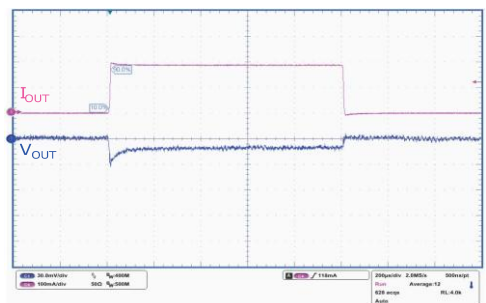

$V_{IN} = V_{EN} = 5.5\text{ V}$, I_{OUT} = from 0 to 0.2 A, $V_{OUT} = 5\text{ V}$, $t_r = t_f = 5\text{ }\mu\text{s}$

AM13878V1

8 Package information

In order to meet environmental requirements, ST offers these devices in different grades of ECOPACK® packages, depending on their level of environmental compliance. ECOPACK® specifications, grade definitions and product status are available at: www.st.com. ECOPACK® is an ST trademark.

8.1 STSTAMP™ (0.47x0.47) mm² package information

Figure 28: STSTAMP™ (0.47x0.47) mm² package outline

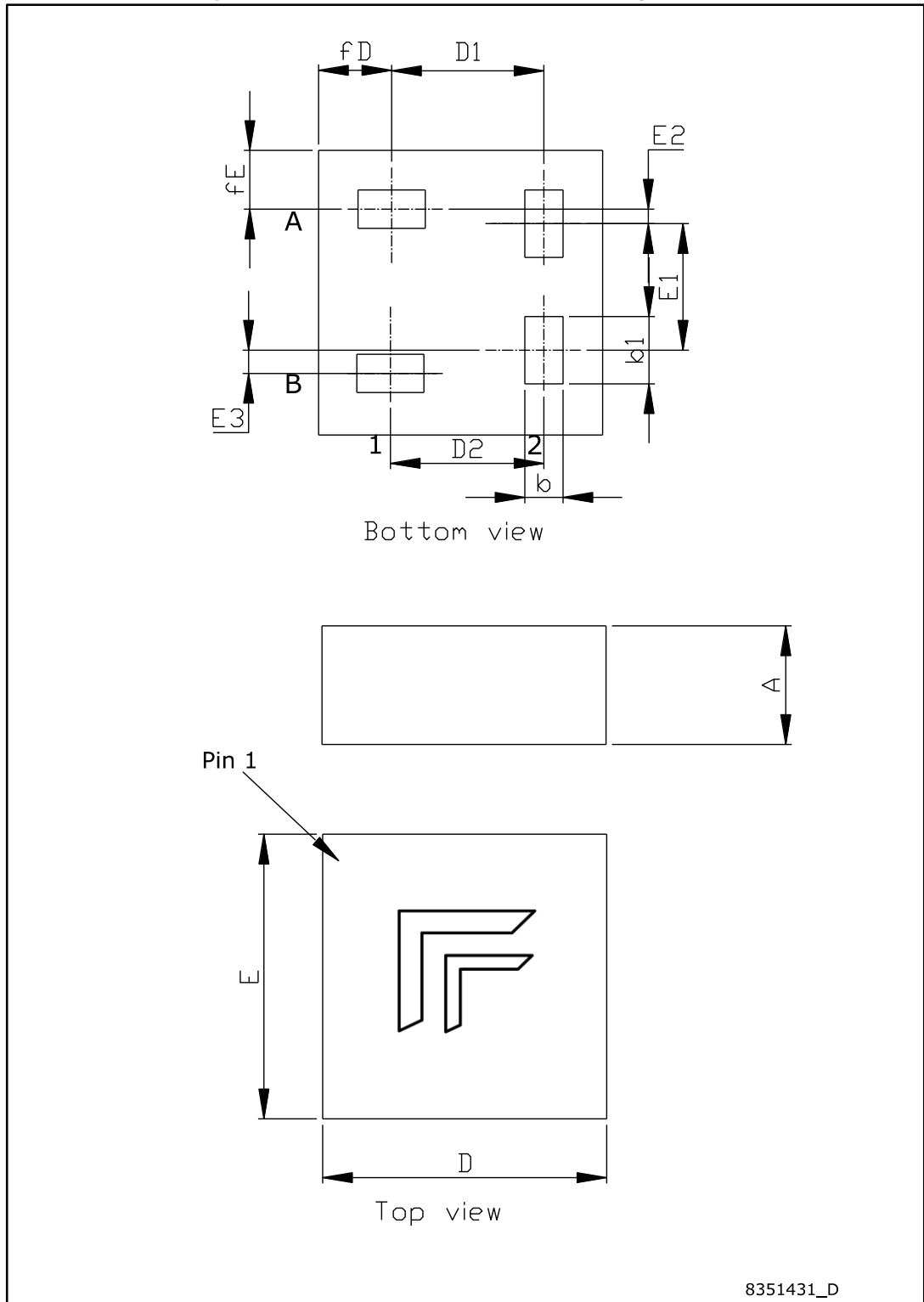

Table 5: STSTAMP™ (0.47x0.47) mm² mechanical data

Dim.	mm		
	Min.	Typ.	Max.
A	0.18	0.200	0.220
b	0.060	0.065	0.070
b1	0.109	0.114	0.119
E	0.450	0.480	0.510
E1	0.208	0.213	0.218
E2	0.019	0.024	0.029
E3	0.034	0.039	0.044
D	0.450	0.480	0.510
D1	0.252	0.257	0.262
D2	0.255	0.260	0.265
fE	0.095	0.101	0.106
fD	0.106	0.111	0.116

Figure 29: STSTAMP™ (0.47x0.47) mm² recommended footprint

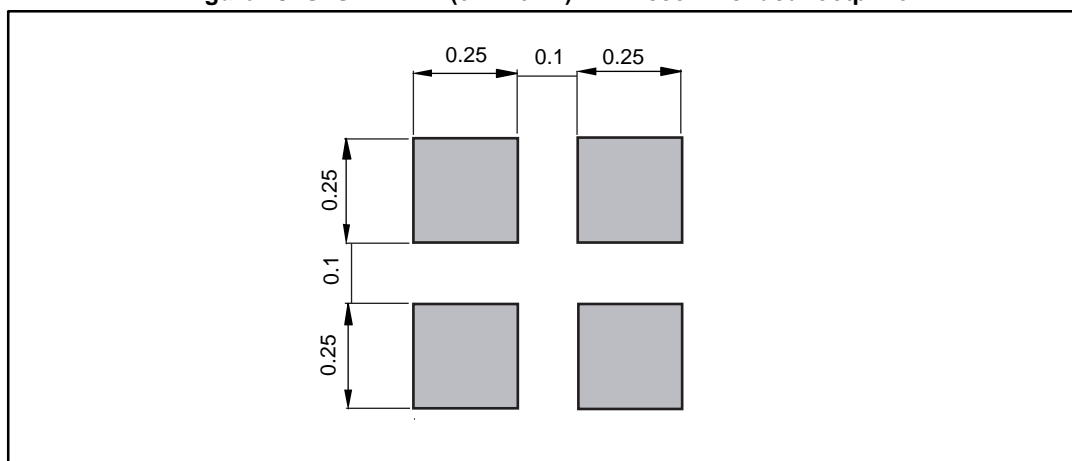
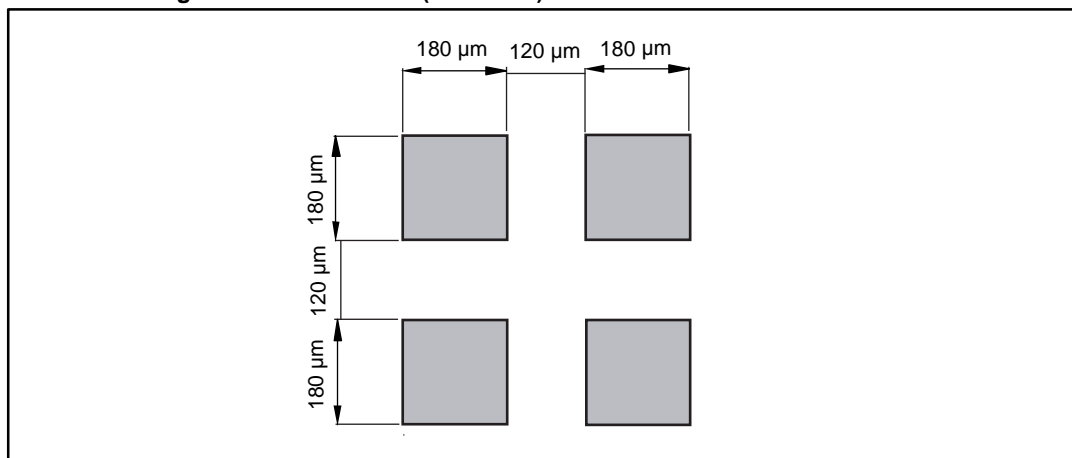

Figure 30: STSTAMP™ (0.47x0.47) mm² recommended solder stencil



9 Ordering information

Table 6: Order code

Order code	Output voltage (V)	Auto-discharge	Packing
LDBL20D-xyR	x.y	Yes	Tape and reel

10 Revision history

Table 7: Document revision history

Date	Revision	Changes
10-Nov-2015	1	Initial release

IMPORTANT NOTICE – PLEASE READ CAREFULLY

STMicroelectronics NV and its subsidiaries ("ST") reserve the right to make changes, corrections, enhancements, modifications, and improvements to ST products and/or to this document at any time without notice. Purchasers should obtain the latest relevant information on ST products before placing orders. ST products are sold pursuant to ST's terms and conditions of sale in place at the time of order acknowledgement.

Purchasers are solely responsible for the choice, selection, and use of ST products and ST assumes no liability for application assistance or the design of Purchasers' products.

No license, express or implied, to any intellectual property right is granted by ST herein.

Resale of ST products with provisions different from the information set forth herein shall void any warranty granted by ST for such product.

ST and the ST logo are trademarks of ST. All other product or service names are the property of their respective owners.

Information in this document supersedes and replaces information previously supplied in any prior versions of this document.

© 2015 STMicroelectronics – All rights reserved

Mouser Electronics

Authorized Distributor

Click to View Pricing, Inventory, Delivery & Lifecycle Information:

[STMicroelectronics:](#)

[LDBL20D-25R](#)