



# STB40NF10

N-channel 100V - 0.025Ω - 50A - D<sup>2</sup>PAK  
Low gate charge STripFET™ II Power MOSFET

## General features

Type	V <sub>DSS</sub>	R <sub>DS(on)</sub>	I <sub>D</sub>
STB40NF10	100V	<0.028Ω	50A

- Exceptional dv/dt capability
- Low gate charge at 100°C
- 100% avalanche tested
- Application oriented characterization

## Description

This Power MOSFET is the latest development of STMicroelectronics unique "Single Feature Size™" strip-based process. The resulting transistor shows extremely high packing density for low on-resistance, rugged avalanche characteristics and less critical alignment steps therefore a remarkable manufacturing reproducibility.

## Applications

- Switching application

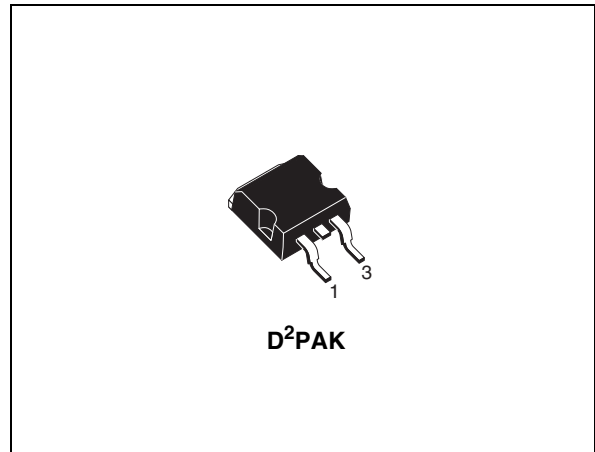

## Internal schematic diagram

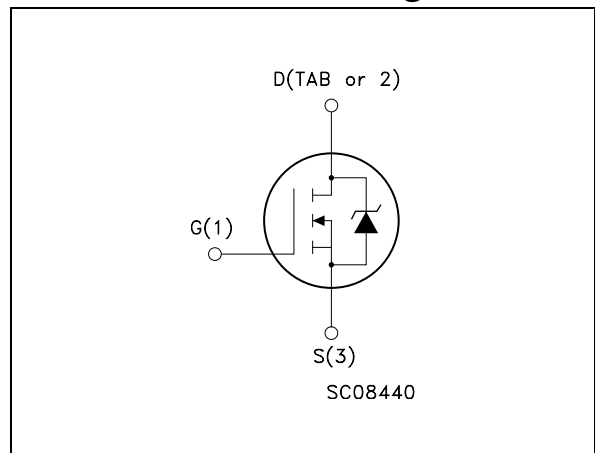

## Order codes

Part number	Marking	Package	Packaging
STB40NF10T4	B40NF10	D <sup>2</sup> PAK	Tape & reel

# Contents

<b>1</b>	<b>Electrical ratings</b> .....	<b>3</b>
<b>2</b>	<b>Electrical characteristics</b> .....	<b>4</b>
	2.1 Electrical characteristics (curves) .....	6
<b>3</b>	<b>Test circuit</b> .....	<b>8</b>
<b>4</b>	<b>Package mechanical data</b> .....	<b>9</b>
<b>5</b>	<b>Packing mechanical data</b> .....	<b>11</b>
<b>6</b>	<b>Revision history</b> .....	<b>12</b>

# 1 Electrical ratings

**Table 1. Absolute maximum ratings**

Symbol	Parameter	Value	Unit
$V_{DS}$	Drain-source voltage ( $V_{GS} = 0$ )	100	V
$V_{DGR}$	Drain-gate voltage ( $R_{GS} = 20\text{ k}\Omega$ )	100	V
$V_{GS}$	Gate- source voltage	$\pm 20$	V
$I_D^{(1)}$	Drain current (continuous) at $T_C = 25^\circ\text{C}$	50	A
$I_D$	Drain current (continuous) at $T_C = 100^\circ\text{C}$	35	A
$I_{DM}^{(2)}$	Drain current (pulsed)	200	A
$P_{tot}$	Total dissipation at $T_C = 25^\circ\text{C}$	150	W
	Derating Factor	1	W/°C
$dv/dt^{(3)}$	Peak diode recovery avalanche energy	20	V/ns
$E_{AS}^{(4)}$	Single pulse avalanche energy	150	mJ
$T_{stg}$	Storage temperature	-50 to 175	°C
$T_j$	Max. operating junction temperature		

1. Pulse width limited by safe operating area
2. Pulse width limited by safe operating area.
3.  $I_{SD} \leq 50\text{A}$ ,  $di/dt \leq 500\text{A}/\mu\text{s}$ ,  $V_{DD} = V_{(BR)DSS}$ ,  $T_j \leq T_{JMAX}$
4. Starting  $T_j = 25^\circ\text{C}$ ,  $I_D = 50\text{A}$ ,  $V_{DD} = 25\text{V}$

**Table 2. Thermal data**

$R_{thj-case}$	Thermal resistance junction-case max	1	°C/W
$R_{thj-amb}$	Thermal resistance junction-ambient max	62.5	°C/W
$T_J$	Maximum lead temperature for soldering purpose	300	°C

## 2 Electrical characteristics

( $T_{CASE}=25^{\circ}C$  unless otherwise specified)

**Table 3. On/off states**

Symbol	Parameter	Test conditions	Min.	Typ.	Max.	Unit
$V_{(BR)DSS}$	Drain-source breakdown voltage	$I_D = 250\mu A, V_{GS} = 0$	100			V
$I_{DSS}$	Zero gate voltage drain current ( $V_{GS} = 0$ )	$V_{DS} = \text{Max rating}$ $V_{DS} = \text{Max rating},$ $T_C = 125^{\circ}C$			1 10	$\mu A$ $\mu A$
$I_{GSS}$	Gate-body leakage current ( $V_{DS} = 0$ )	$V_{GS} = \pm 20V$			$\pm 100$	nA
$V_{GS(th)}$	Gate threshold voltage	$V_{DS} = V_{GS}, I_D = 250\mu A$	2	2.8	4	V
$R_{DS(on)}$	Static drain-source on resistance	$V_{GS} = 10V, I_D = 25A$		0.024	0.028	$\Omega$

**Table 4. Dynamic**

Symbol	Parameter	Test conditions	Min.	Typ.	Max.	Unit
$g_{fs}^{(1)}$	Forward transconductance	$V_{DS} = 25V, I_D = 25A$		20		S
$C_{iss}$ $C_{oss}$ $C_{rss}$	Input capacitance Output capacitance Reverse transfer capacitance	$V_{DS} = 25V, f = 1MHz,$ $V_{GS} = 0$		1780 265 112		pF pF pF
$t_{d(on)}$ $t_r$ $t_{d(off)}$ $t_f$	Turn-on delay time Rise time Turn-off delay time Fall time	$V_{DD} = 50V, I_D = 25A$ $R_G = 4.7\Omega, V_{GS} = 10V$ (see <a href="#">Figure 13</a> )		28 63 84 28		ns ns ns ns
$Q_g$ $Q_{gs}$ $Q_{gd}$	Total gate charge Gate-source charge Gate-drain charge	$V_{DD} = 80V, I_D = 50A,$ $V_{GS} = 10V, R_G = 4.7\Omega$ (see <a href="#">Figure 14</a> )		60.6 9.6 22.8	80	nC nC nC

1. Pulsed: Pulse duration = 300  $\mu s$ , duty cycle 1.5 %.

**Table 5. Source drain diode**

Symbol	Parameter	Test conditions	Min.	Typ.	Max.	Unit
$I_{SD}$ $I_{SDM}^{(1)}$	Source-drain current Source-drain current (pulsed)				50 200	A A
$V_{SD}^{(2)}$	Forward on voltage	$I_{SD} = 50A, V_{GS} = 0$			1.3	V
$t_{rr}$ $Q_{rr}$ $I_{RRM}$	Reverse recovery time Reverse recovery charge Reverse recovery current	$I_{SD} = 50A, di/dt = 100A/\mu s,$ $V_{DD} = 25V, T_j = 150^\circ C$ (see <a href="#">Figure 15</a> )		114 456 8		ns nC A

1. Pulse width limited by safe operating area.
2. Pulsed: Pulse duration = 300  $\mu s$ , duty cycle 1.5 %

## 2.1 Electrical characteristics (curves)

Figure 1. Safe operating area

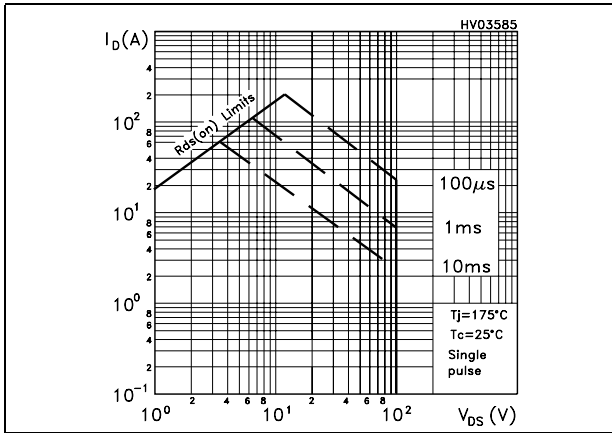

Figure 2. Thermal impedance

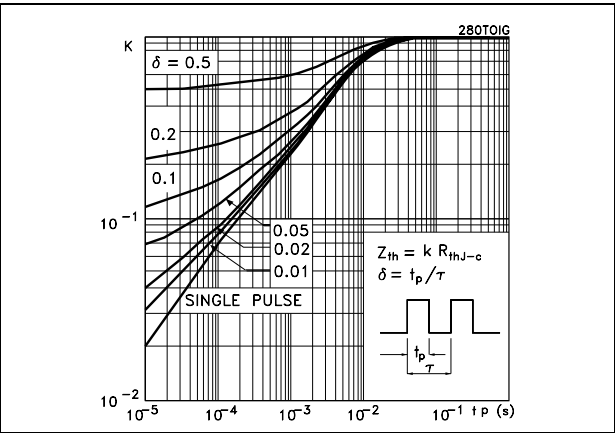

Figure 3. Output characteristics

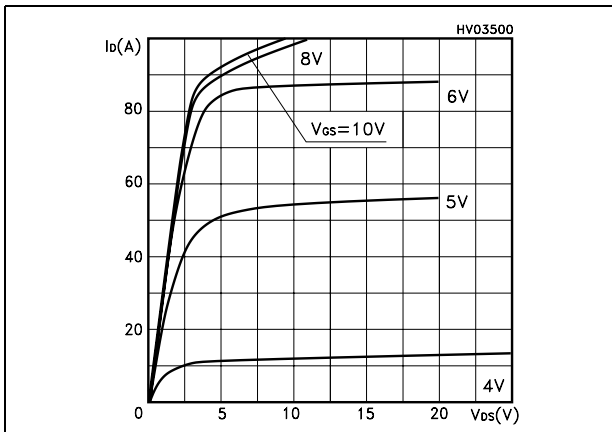

Figure 4. Transfer characteristics

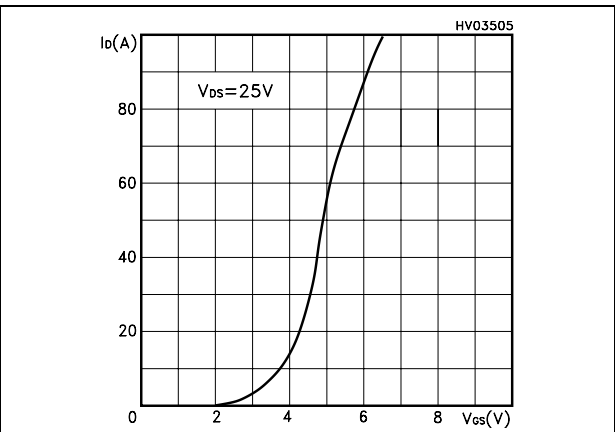

Figure 5. Transconductance

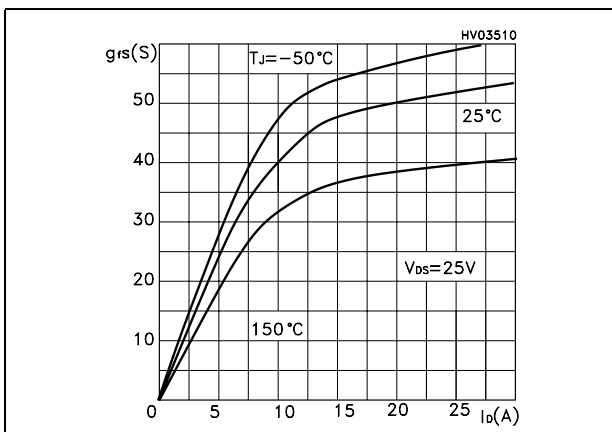

Figure 6. Static drain-source on resistance

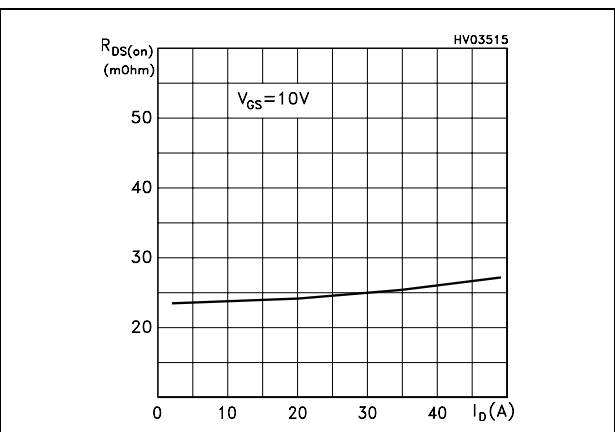

Figure 7. Gate charge vs gate-source voltage Figure 8. Capacitance variations

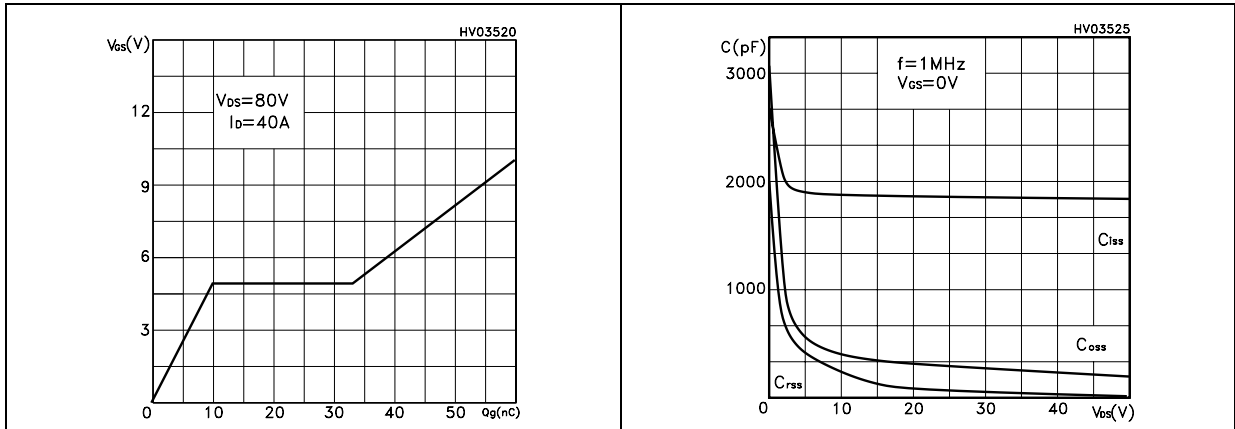

Figure 9. Normalized gate threshold voltage vs temperature Figure 10. Normalized on resistance vs temperature

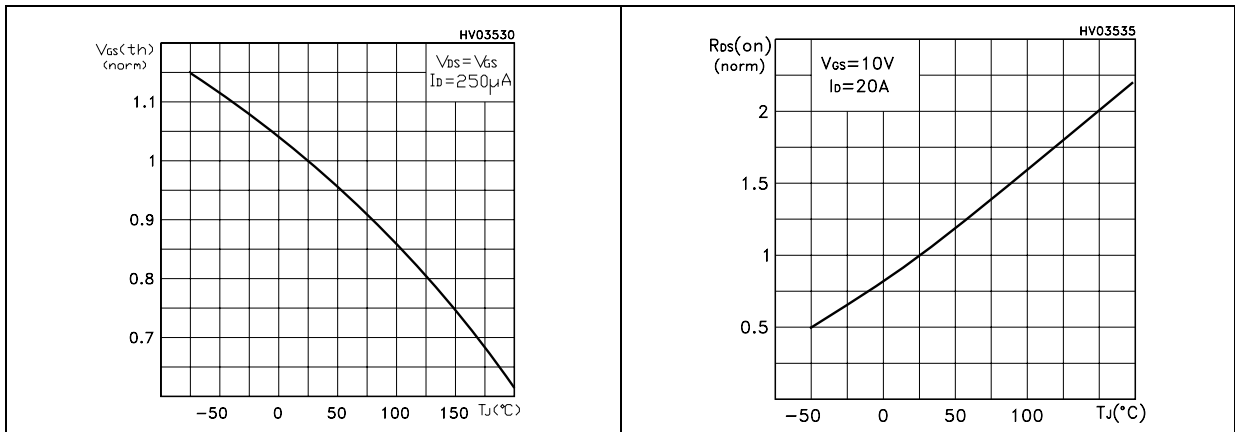
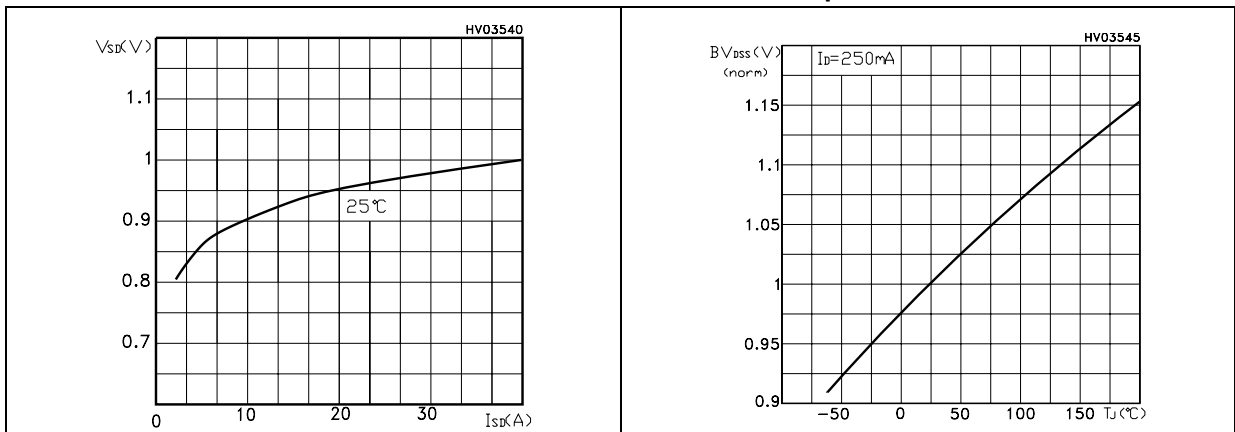

Figure 11. Source-drain diode forward characteristics Figure 12. Normalized breakdown voltage vs temperature



### 3 Test circuit

Figure 13. Switching times test circuit for resistive load



Figure 14. Gate charge test circuit



Figure 15. Test circuit for inductive load switching and diode recovery times



Figure 16. Unclamped Inductive load test circuit

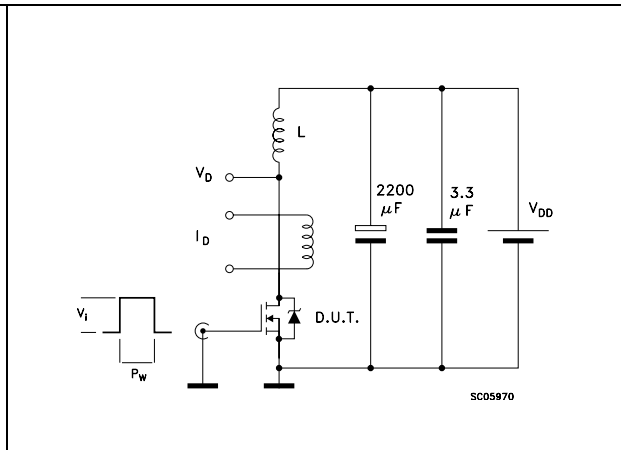
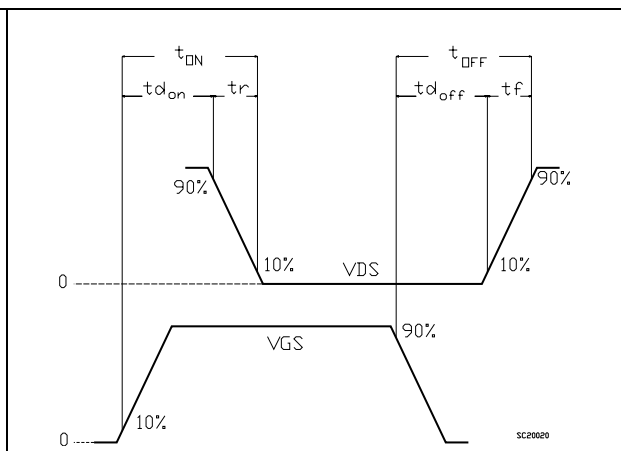

Figure 17. Unclamped inductive waveform



Figure 18. Switching time waveform





## 4 Package mechanical data

In order to meet environmental requirements, ST offers these devices in ECOPACK® packages. These packages have a Lead-free second level interconnect . The category of second level interconnect is marked on the package and on the inner box label, in compliance with JEDEC Standard JESD97. The maximum ratings related to soldering conditions are also marked on the inner box label. ECOPACK is an ST trademark. ECOPACK specifications are available at: [www.st.com](http://www.st.com)

**D<sup>2</sup>PAK MECHANICAL DATA**

DIM.	mm.			inch		
	MIN.	TYP.	MAX.	MIN.	TYP.	MAX.
A	4.4		4.6	0.173		0.181
A1	2.49		2.69	0.098		0.106
A2	0.03		0.23	0.001		0.009
B	0.7		0.93	0.027		0.036
B2	1.14		1.7	0.044		0.067
C	0.45		0.6	0.017		0.023
C2	1.23		1.36	0.048		0.053
D	8.95		9.35	0.352		0.368
D1		8			0.315	
E	10		10.4	0.393		
E1		8.5			0.334	
G	4.88		5.28	0.192		0.208
L	15		15.85	0.590		0.625
L2	1.27		1.4	0.050		0.055
L3	1.4		1.75	0.055		0.068
M	2.4		3.2	0.094		0.126
R		0.4			0.015	
V2	0°		4°			

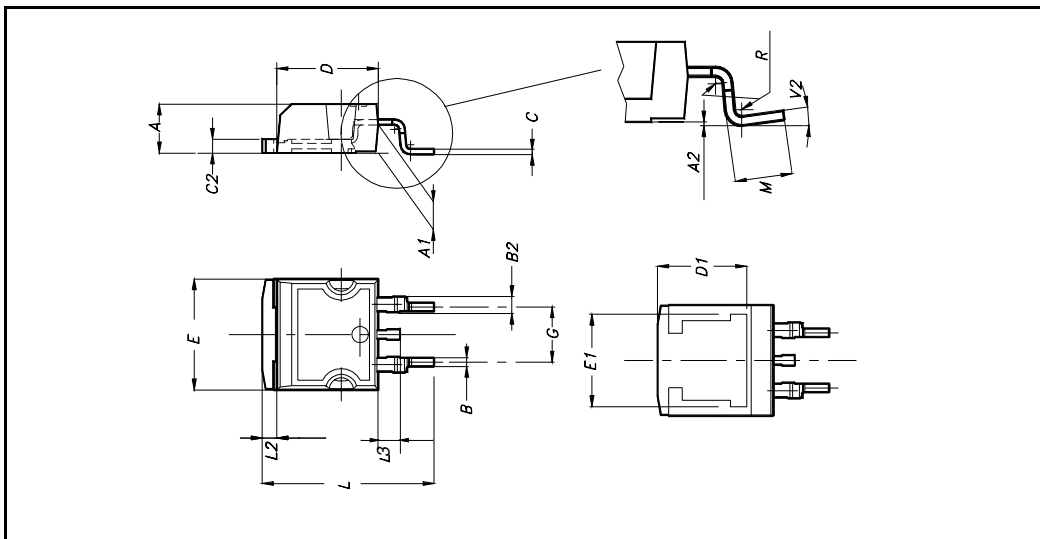

# 5 Packing mechanical data

## D<sup>2</sup>PAK FOOTPRINT

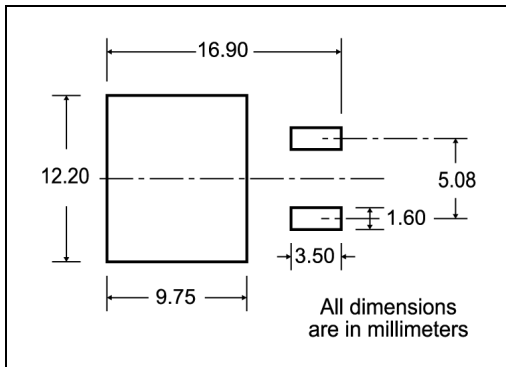

## TAPE AND REEL SHIPMENT

**TAPE MECHANICAL DATA**

DIM.	mm		inch	
	MIN.	MAX.	MIN.	MAX.
A0	10.5	10.7	0.413	0.421
B0	15.7	15.9	0.618	0.626
D	1.5	1.6	0.059	0.063
D1	1.59	1.61	0.062	0.063
E	1.65	1.85	0.065	0.073
F	11.4	11.6	0.449	0.456
K0	4.8	5.0	0.189	0.197
P0	3.9	4.1	0.153	0.161
P1	11.9	12.1	0.468	0.476
P2	1.9	2.1	0.075	0.082
R	50		1.574	
T	0.25	0.35	0.0098	0.0137
W	23.7	24.3	0.933	0.956

**REEL MECHANICAL DATA**

DIM.	mm		inch	
	MIN.	MAX.	MIN.	MAX.
A		330		12.992
B	1.5		0.059	
C	12.8	13.2	0.504	0.520
D	20.2		0.795	
G	24.4	26.4	0.960	1.039
N	100		3.937	
T		30.4		1.197

BASE QTY	BULK QTY
1000	1000

\* on sales type

## 6 Revision history

**Table 6. Revision history**

<b>Date</b>	<b>Revision</b>	<b>Changes</b>
21-Jun-2004	10	Preliminary version
15-Dec-2004	11	Complete version
26-Jun-2006	12	New template, no content change

**Please Read Carefully:**

Information in this document is provided solely in connection with ST products. STMicroelectronics NV and its subsidiaries ("ST") reserve the right to make changes, corrections, modifications or improvements, to this document, and the products and services described herein at any time, without notice.

All ST products are sold pursuant to ST's terms and conditions of sale.

Purchasers are solely responsible for the choice, selection and use of the ST products and services described herein, and ST assumes no liability whatsoever relating to the choice, selection or use of the ST products and services described herein.

No license, express or implied, by estoppel or otherwise, to any intellectual property rights is granted under this document. If any part of this document refers to any third party products or services it shall not be deemed a license grant by ST for the use of such third party products or services, or any intellectual property contained therein or considered as a warranty covering the use in any manner whatsoever of such third party products or services or any intellectual property contained therein.

**UNLESS OTHERWISE SET FORTH IN ST'S TERMS AND CONDITIONS OF SALE ST DISCLAIMS ANY EXPRESS OR IMPLIED WARRANTY WITH RESPECT TO THE USE AND/OR SALE OF ST PRODUCTS INCLUDING WITHOUT LIMITATION IMPLIED WARRANTIES OF MERCHANTABILITY, FITNESS FOR A PARTICULAR PURPOSE (AND THEIR EQUIVALENTS UNDER THE LAWS OF ANY JURISDICTION), OR INFRINGEMENT OF ANY PATENT, COPYRIGHT OR OTHER INTELLECTUAL PROPERTY RIGHT.**

**UNLESS EXPRESSLY APPROVED IN WRITING BY AN AUTHORIZED REPRESENTATIVE OF ST, ST PRODUCTS ARE NOT DESIGNED, AUTHORIZED OR WARRANTED FOR USE IN MILITARY, AIR CRAFT, SPACE, LIFE SAVING, OR LIFE SUSTAINING APPLICATIONS, NOR IN PRODUCTS OR SYSTEMS, WHERE FAILURE OR MALFUNCTION MAY RESULT IN PERSONAL INJURY, DEATH, OR SEVERE PROPERTY OR ENVIRONMENTAL DAMAGE.**

Resale of ST products with provisions different from the statements and/or technical features set forth in this document shall immediately void any warranty granted by ST for the ST product or service described herein and shall not create or extend in any manner whatsoever, any liability of ST.

ST and the ST logo are trademarks or registered trademarks of ST in various countries.

Information in this document supersedes and replaces all information previously supplied.

The ST logo is a registered trademark of STMicroelectronics. All other names are the property of their respective owners.

© 2006 STMicroelectronics - All rights reserved

STMicroelectronics group of companies

Australia - Belgium - Brazil - Canada - China - Czech Republic - Finland - France - Germany - Hong Kong - India - Israel - Italy - Japan - Malaysia - Malta - Morocco - Singapore - Spain - Sweden - Switzerland - United Kingdom - United States of America

[www.st.com](http://www.st.com)

# Mouser Electronics

Authorized Distributor

Click to View Pricing, Inventory, Delivery & Lifecycle Information:

[STMicroelectronics:](#)

[STB40NF10T4](#)