

Trench gate field-stop IGBT M series, 650 V, 15 A low loss

Datasheet - production data

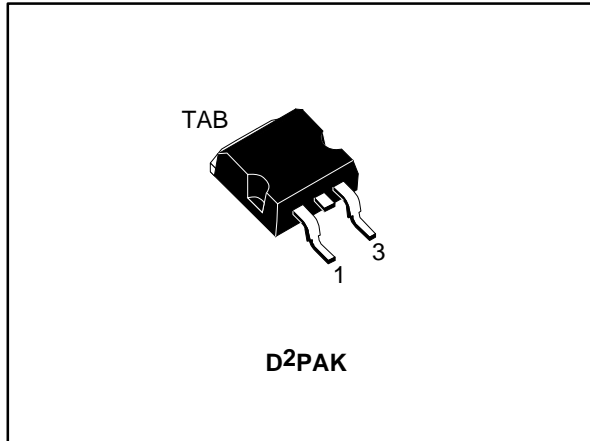
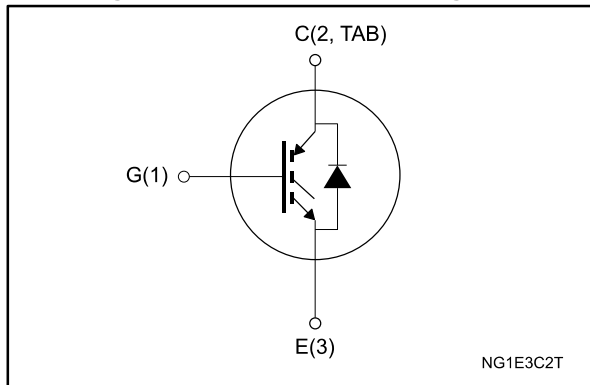

Figure 1: Internal schematic diagram



Features

- 6 μ s of short-circuit withstand time
- $V_{CE(sat)} = 1.55$ V (typ.) @ $I_C = 15$ A
- Tight parameter distribution
- Safer paralleling
- Low thermal resistance
- Soft and very fast recovery antiparallel diode

Applications

- Motor control
- UPS
- PFC

Description

This device is an IGBT developed using an advanced proprietary trench gate field-stop structure. The device is part of the M series of IGBTs, which represent an optimum compromise in performance to maximize the efficiency of inverter systems where low-loss and short-circuit capability are essential. Furthermore, a positive $V_{CE(sat)}$ temperature coefficient and tight parameter distribution result in safer paralleling operation.

Table 1: Device summary

Order code	Marking	Package	Packing
STGB15M65DF2	G15M65DF2	D ² PAK	Tape and reel

Contents

1	Electrical ratings	3
2	Electrical characteristics	4
	2.1 Electrical characteristics (curves).....	6
3	Test circuits	12
4	Package information	13
	4.1 D ² PAK (TO-263) type A package information	13
	4.2 D ² PAK packing information	16
5	Revision history	18

1 Electrical ratings

Table 2: Absolute maximum ratings

Symbol	Parameter	Value	Unit
V_{CES}	Collector-emitter voltage ($V_{GE} = 0$ V)	650	V
I_C	Continuous collector current at $T_C = 25$ °C	30	A
	Continuous collector current at $T_C = 100$ °C	15	
$I_{CP}^{(1)}$	Pulsed collector current	60	A
V_{GE}	Gate-emitter voltage	±20	V
I_F	Continuous forward current at $T_C = 25$ °C	30	A
	Continuous forward current at $T_C = 100$ °C	15	
$I_{FP}^{(1)}$	Pulsed forward current	60	A
P_{TOT}	Total dissipation at $T_C = 25$ °C	136	W
T_{STG}	Storage temperature range	- 55 to 150	°C
T_J	Operating junction temperature	- 55 to 175	°C

Notes:

⁽¹⁾Pulse width limited by maximum junction temperature.

Table 3: Thermal data

Symbol	Parameter	Value	Unit
R_{thJC}	Thermal resistance junction-case IGBT	1.1	°C/W
R_{thJC}	Thermal resistance junction-case diode	2.08	
R_{thJA}	Thermal resistance junction-ambient	62.5	

2 Electrical characteristics

$T_C = 25\text{ °C}$ unless otherwise specified

Table 4: Static characteristics

Symbol	Parameter	Test conditions	Min.	Typ.	Max.	Unit
$V_{(BR)CES}$	Collector-emitter breakdown voltage	$V_{GE} = 0\text{ V}$, $I_C = 2\text{ mA}$	650			V
$V_{CE(sat)}$	Collector-emitter saturation voltage	$V_{GE} = 15\text{ V}$, $I_C = 15\text{ A}$		1.55	2.0	V
		$V_{GE} = 15\text{ V}$, $I_C = 15\text{ A}$, $T_J = 125\text{ °C}$		1.9		
		$V_{GE} = 15\text{ V}$, $I_C = 15\text{ A}$, $T_J = 175\text{ °C}$		2.1		
V_F	Forward on-voltage	$I_F = 15\text{ A}$		1.7		V
		$I_F = 15\text{ A}$, $T_J = 125\text{ °C}$		1.5		
		$I_F = 15\text{ A}$, $T_J = 175\text{ °C}$		1.4		
$V_{GE(th)}$	Gate threshold voltage	$V_{CE} = V_{GE}$, $I_C = 500\text{ }\mu\text{A}$	5	6	7	V
I_{CES}	Collector cut-off current	$V_{GE} = 0\text{ V}$, $V_{CE} = 650\text{ V}$			25	μA
I_{GES}	Gate-emitter leakage current	$V_{CE} = 0\text{ V}$, $V_{GE} = \pm 20\text{ V}$			± 250	μA

Table 5: Dynamic characteristics

Symbol	Parameter	Test conditions	Min.	Typ.	Max.	Unit
C_{ies}	Input capacitance	$V_{CE} = 25\text{ V}$, $f = 1\text{ MHz}$, $V_{GE} = 0\text{ V}$	-	1250	-	pF
C_{oes}	Output capacitance		-	80	-	
C_{res}	Reverse transfer capacitance		-	25	-	
Q_g	Total gate charge	$V_{CC} = 520\text{ V}$, $I_C = 15\text{ A}$, $V_{GE} = 15\text{ V}$ (see Figure 30: "Gate charge test circuit")	-	45	-	nC
Q_{ge}	Gate-emitter charge		-	11	-	
Q_{gc}	Gate-collector charge		-	15	-	

Table 6: IGBT switching characteristics (inductive load)

Symbol	Parameter	Test conditions	Min.	Typ.	Max.	Unit
$t_{d(on)}$	Turn-on delay time	$V_{CE} = 400\text{ V}$, $I_C = 15\text{ A}$, $V_{GE} = 15\text{ V}$, $R_G = 12\ \Omega$ (see Figure 29: "Test circuit for inductive load switching")		24	-	ns
t_r	Current rise time			7.8	-	ns
$(di/dt)_{on}$	Turn-on current slope			1570	-	A/ μ s
$t_{d(off)}$	Turn-off-delay time			93	-	ns
t_f	Current fall time			106	-	ns
$E_{on}^{(1)}$	Turn-on switching losses			0.09	-	mJ
$E_{off}^{(2)}$	Turn-off switching losses			0.45	-	mJ
E_{ts}	Total switching losses			0.54	-	mJ
$t_{d(on)}$	Turn-on delay time	$V_{CE} = 400\text{ V}$, $I_C = 15\text{ A}$, $V_{GE} = 15\text{ V}$, $R_G = 12\ \Omega$ $T_J = 175\text{ }^\circ\text{C}$ (see Figure 29: "Test circuit for inductive load switching")		24.8	-	ns
t_r	Current rise time			9.2	-	ns
$(di/dt)_{on}$	Turn-on current slope			1300	-	A/ μ s
$t_{d(off)}$	Turn-off-delay time			96	-	ns
t_f	Current fall time			169	-	ns
E_{on}	Turn-on switching losses			0.22	-	mJ
E_{off}	Turn-off switching losses			0.61	-	mJ
E_{ts}	Total switching losses			0.83	-	mJ
t_{sc}	Short-circuit withstand time	$V_{CC} \leq 400\text{ V}$, $V_{GE} = 15\text{ V}$, $T_{Jstart} = 150\text{ }^\circ\text{C}$	6		-	μ s

Notes:

(1)Energy losses include reverse recovery of the diode.

(2)Turn-off losses also include the tail of the collector current.

Table 7: Diode switching characteristics (inductive load)

Symbol	Parameter	Test conditions	Min.	Typ.	Max.	Unit
t_{rr}	Reverse recovery time	$I_F = 15\text{ A}$, $V_R = 400\text{ V}$, $V_{GE} = 15\text{ V}$ (see Figure 29: "Test circuit for inductive load switching") $di/dt = 1000\text{ A}/\mu\text{s}$	-	142	-	ns
Q_{rr}	Reverse recovery charge		-	525	-	nC
I_{rrm}	Reverse recovery current		-	13.4	-	A
dl_{rr}/dt	Peak rate of fall of reverse recovery current during t_b		-	790	-	A/ μ s
E_{rr}	Reverse recovery energy		-	64	-	μ J
t_{rr}	Reverse recovery time	$I_F = 15\text{ A}$, $V_R = 400\text{ V}$, $V_{GE} = 15\text{ V}$ $T_J = 175\text{ }^\circ\text{C}$ (see Figure 29: "Test circuit for inductive load switching") $di/dt = 1000\text{ A}/\mu\text{s}$	-	241	-	ns
Q_{rr}	Reverse recovery charge		-	1690	-	nC
I_{rrm}	Reverse recovery current		-	20	-	A
dl_{rr}/dt	Peak rate of fall of reverse recovery current during t_b		-	420	-	A/ μ s
E_{rr}	Reverse recovery energy		-	176	-	μ J

2.1 Electrical characteristics (curves)

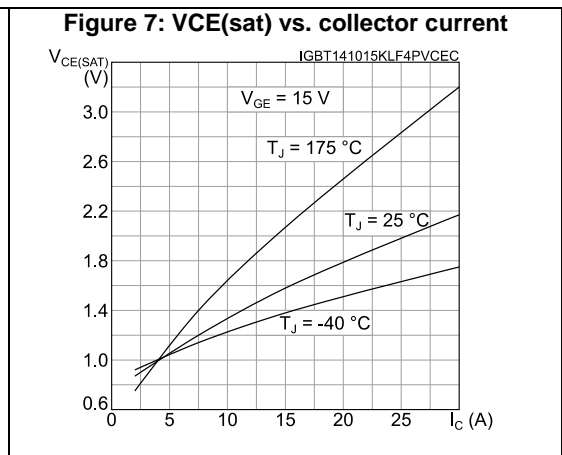
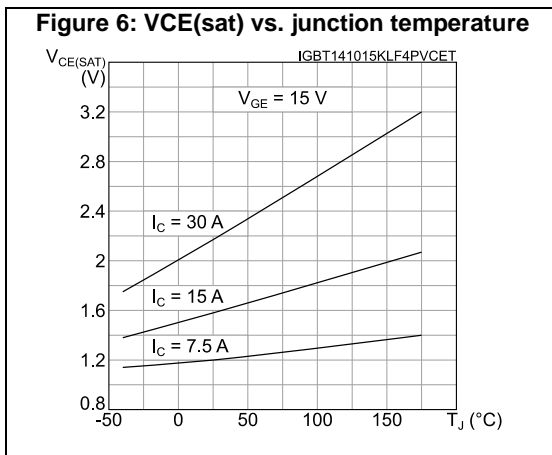
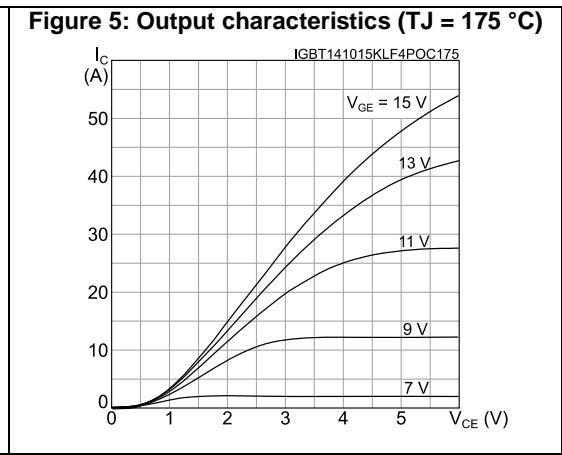
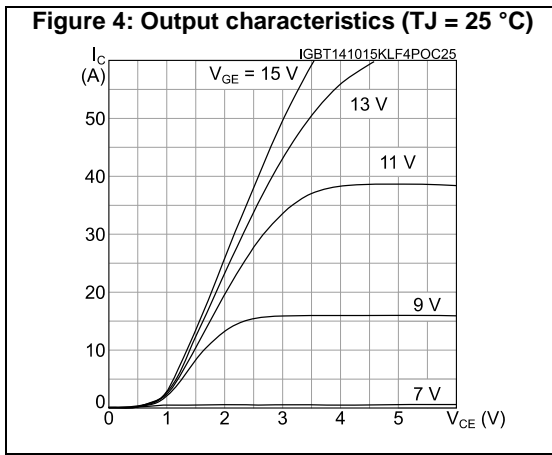
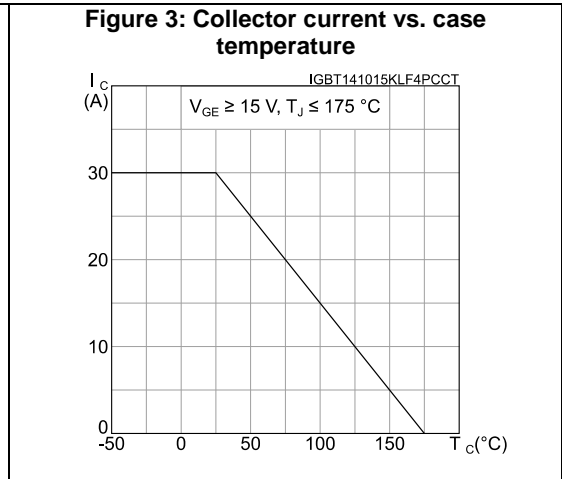
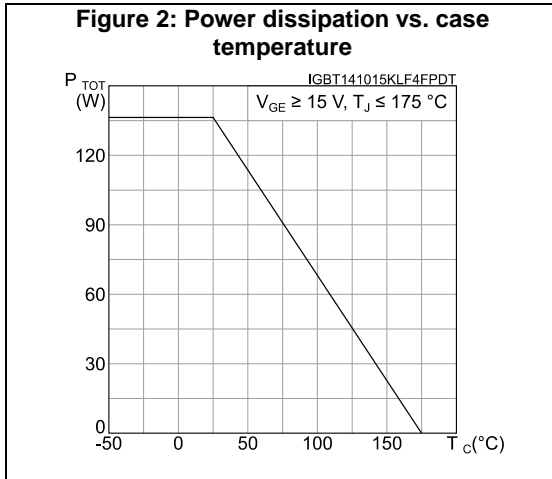

Figure 8: Collector current vs. switching frequency

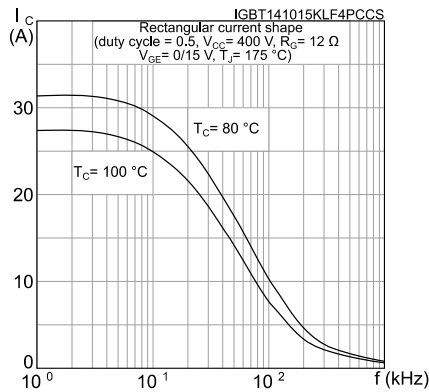

Figure 9: Forward bias safe operating area

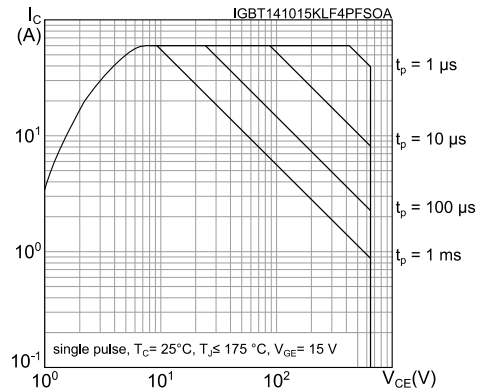

Figure 10: Transfer characteristics

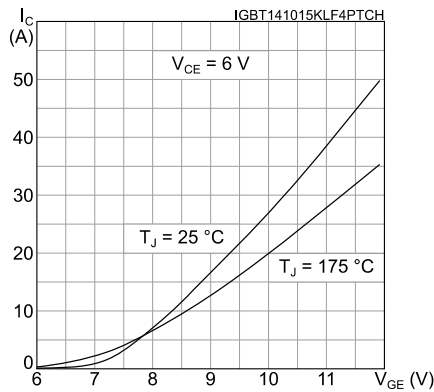

Figure 11: Diode VF vs. forward current

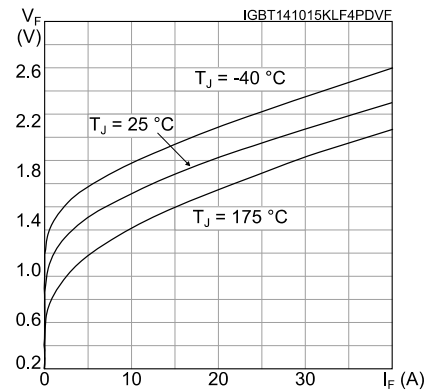

Figure 12: Normalized V_GE(th) vs. junction temperature

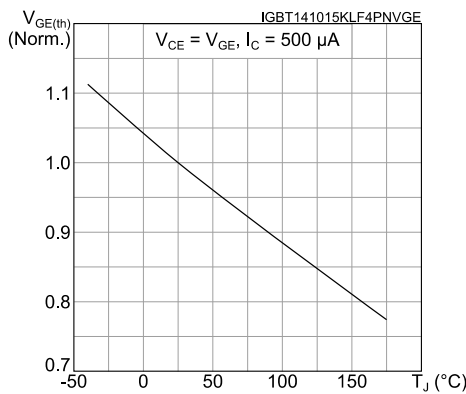
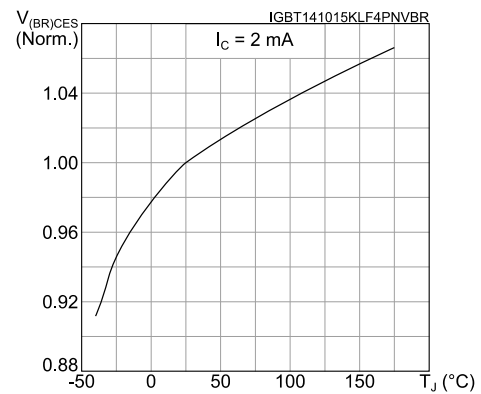

Figure 13: Normalized V(BR)CES vs. junction temperature



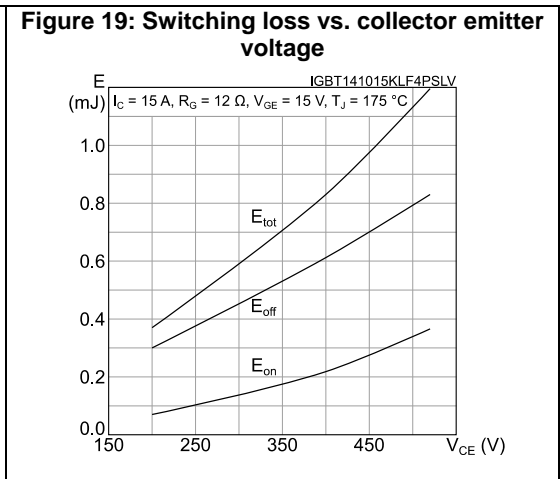
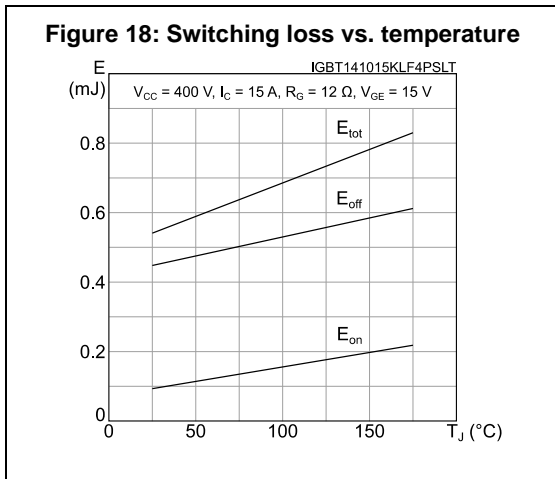
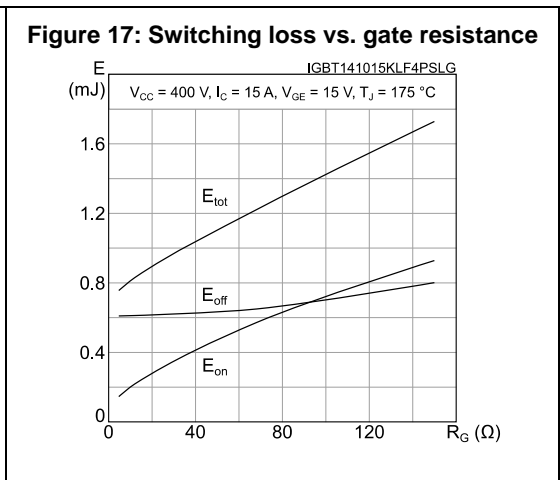
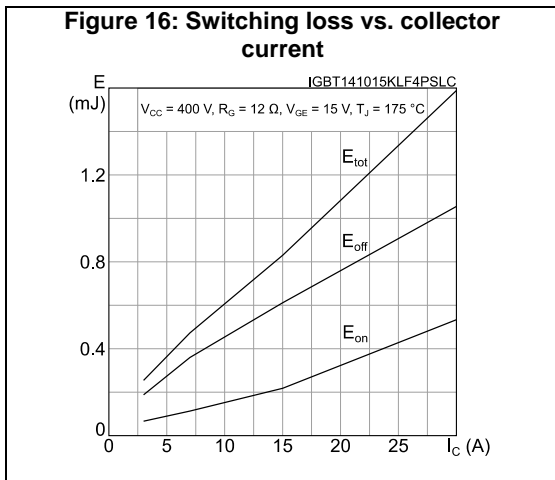
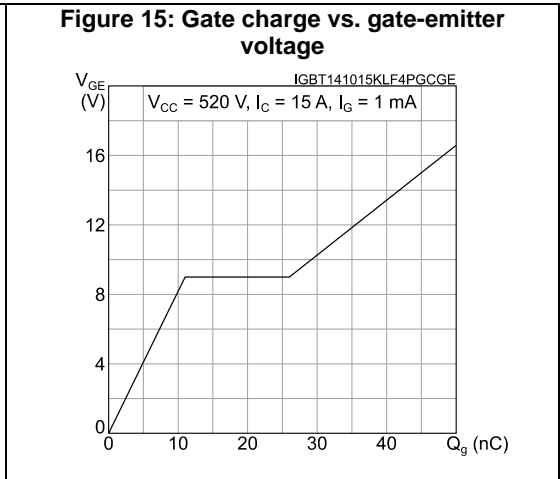
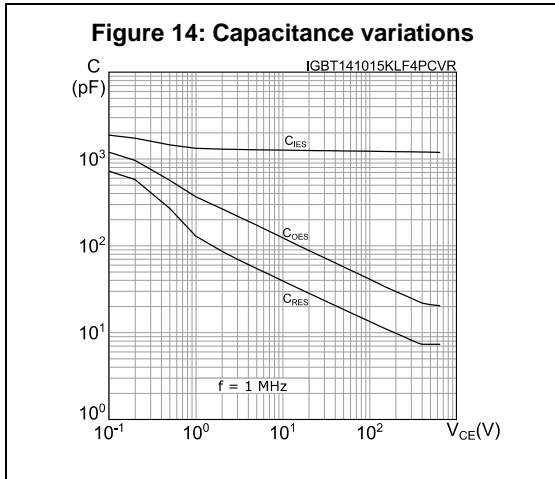

Figure 20: Short-circuit time and current vs. V_{GE}

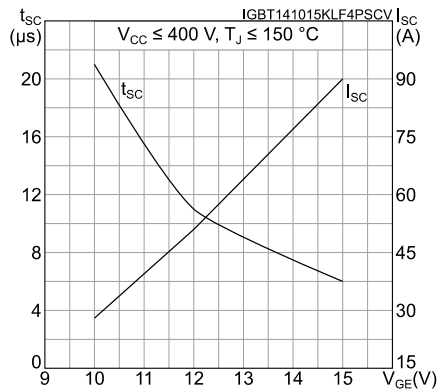

Figure 21: Switching times vs. collector current

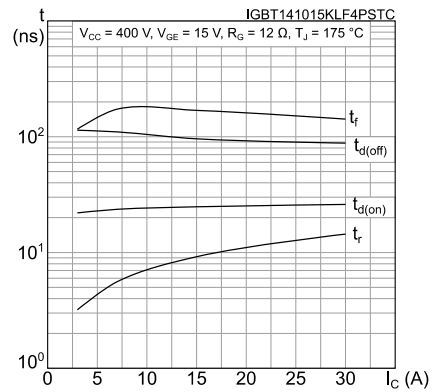

Figure 22: Switching times vs. gate resistance

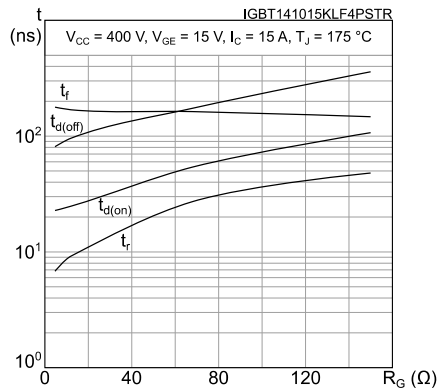

Figure 23: Reverse recovery current vs. diode current slope

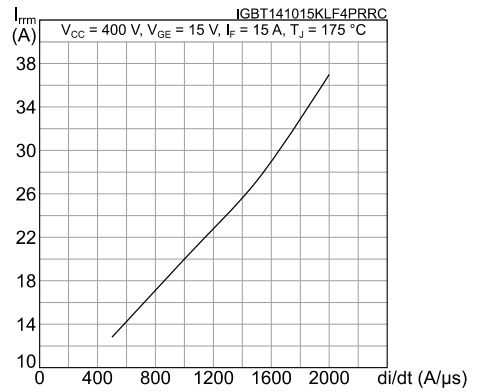

Figure 24: Reverse recovery time vs. diode current slope

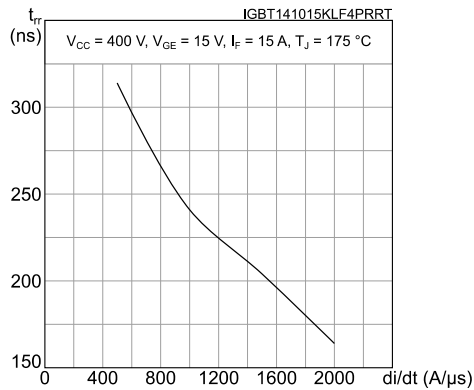

Figure 25: Reverse recovery charge vs. diode current slope

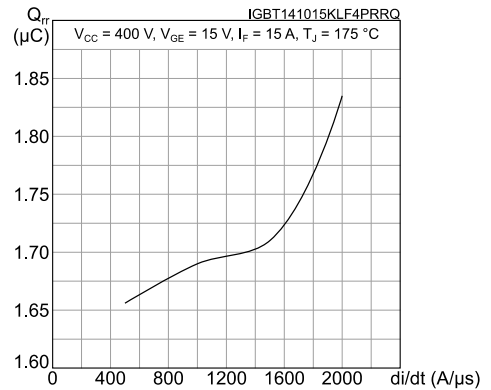

Figure 26: Reverse recovery energy vs. diode current slope

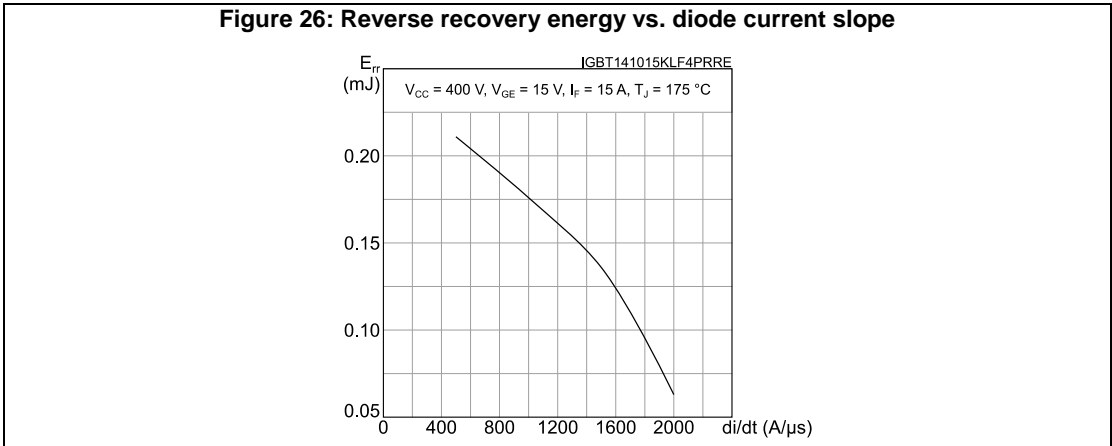

Figure 27: Thermal impedance for IGBT

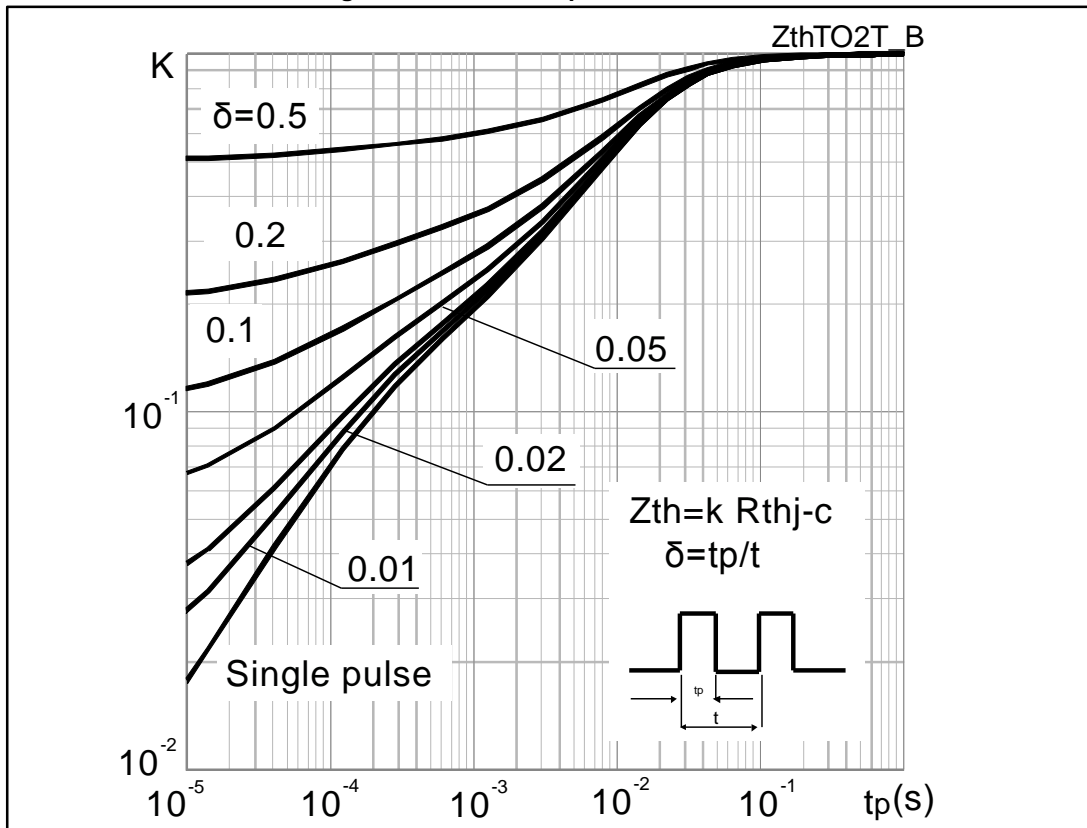
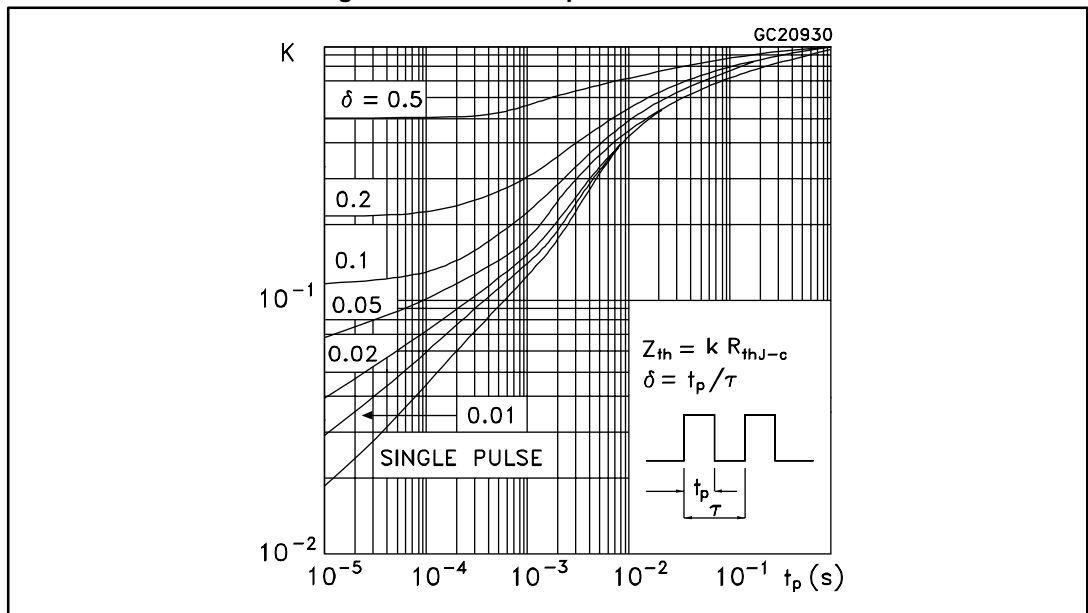
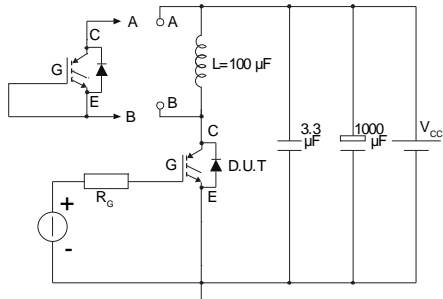

Figure 28: Thermal impedance for diode



3 Test circuits

Figure 29: Test circuit for inductive load switching



AM01504v1

Figure 30: Gate charge test circuit

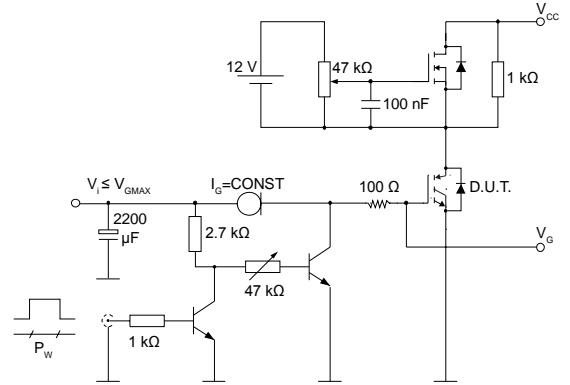

AM01505v1

Figure 31: Switching waveform

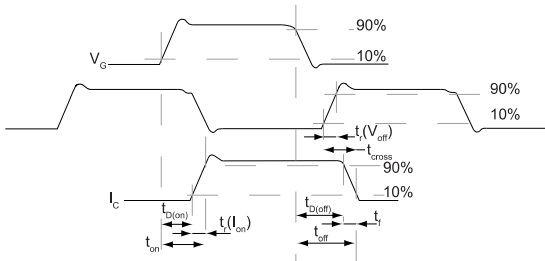

AM01506v1

Figure 32: Diode reverse recovery waveform

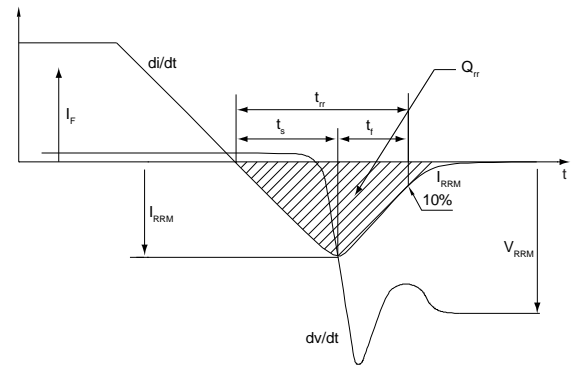

AM01507v1

4 Package information

In order to meet environmental requirements, ST offers these devices in different grades of ECOPACK® packages, depending on their level of environmental compliance. ECOPACK® specifications, grade definitions and product status are available at: www.st.com. ECOPACK® is an ST trademark.

4.1 D²PAK (TO-263) type A package information

Figure 33: D²PAK (TO-263) type A package outline

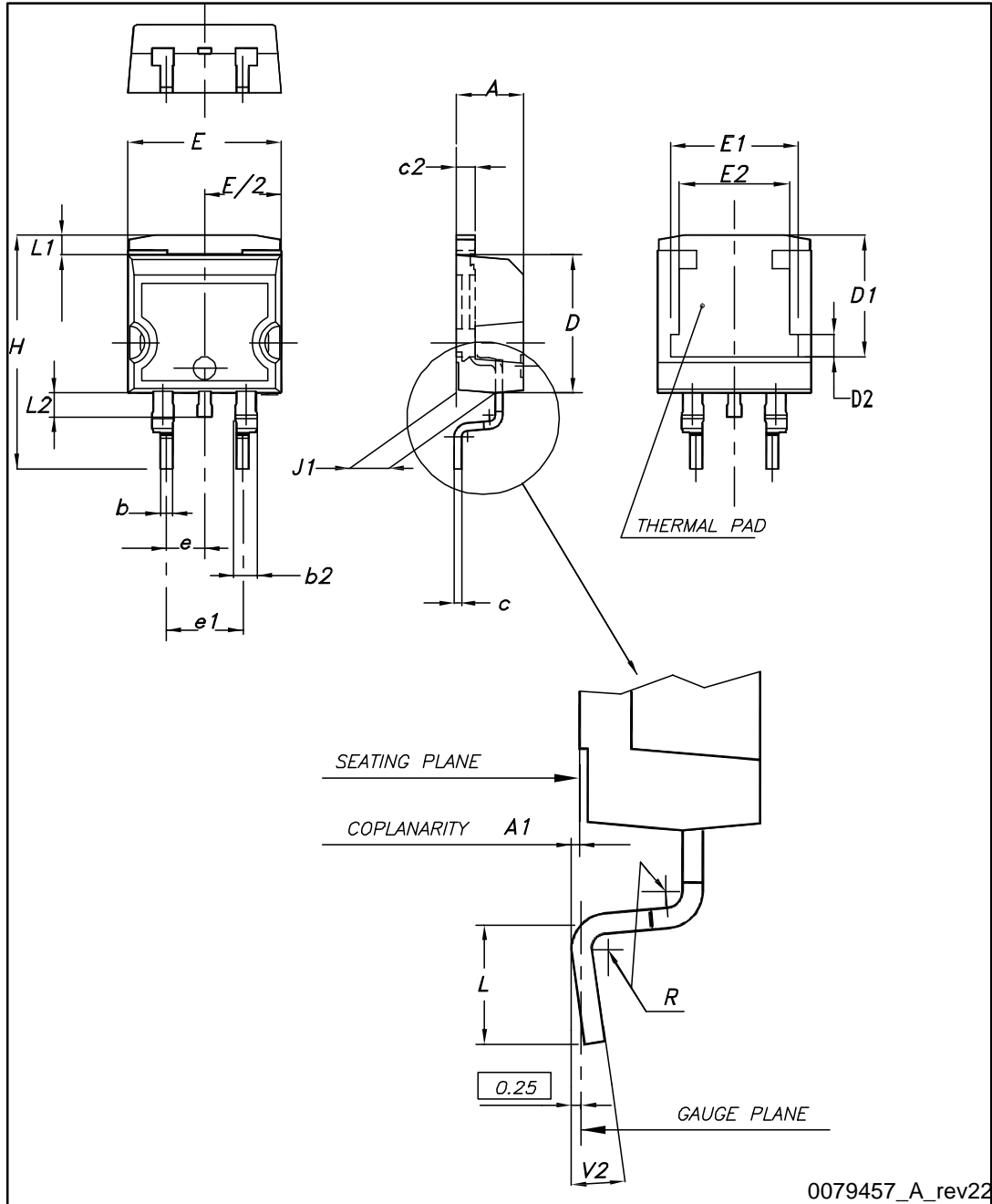
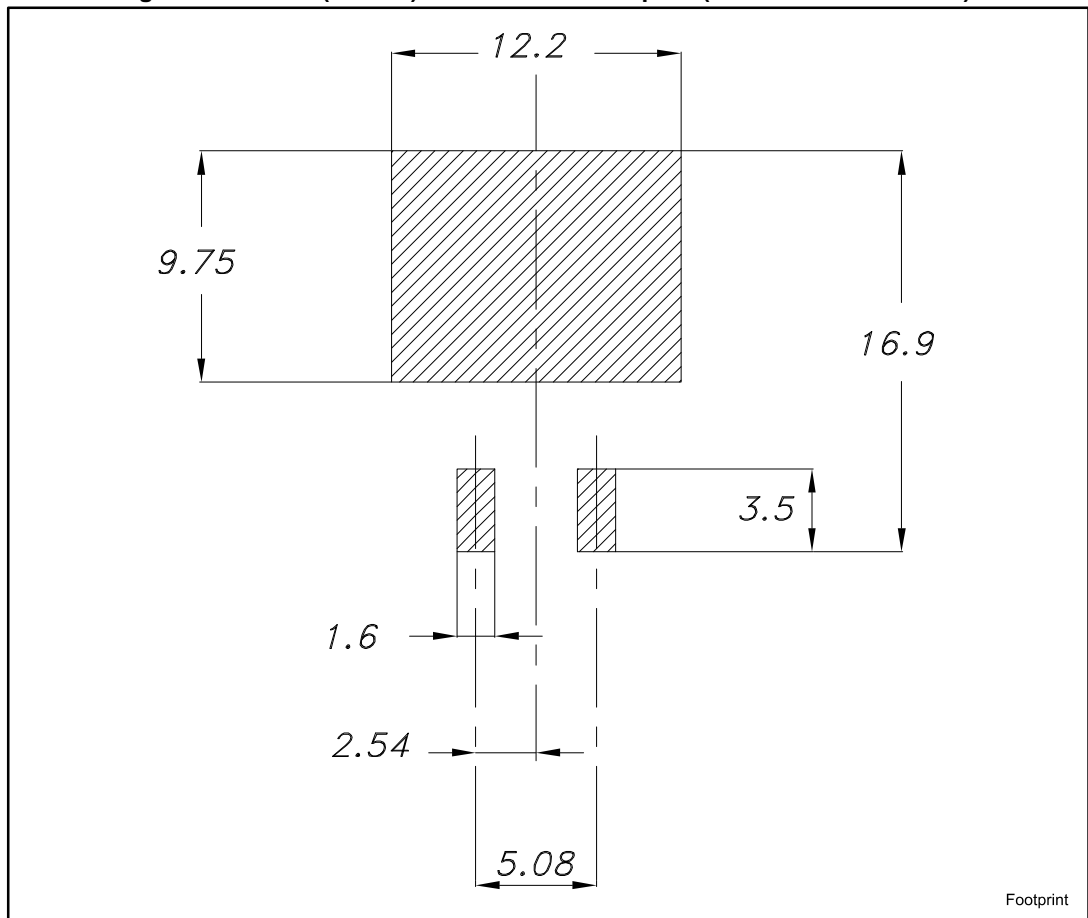

Table 8: D²PAK (TO-263) type A package mechanical data

Dim.	mm		
	Min.	Typ.	Max.
A	4.40		4.60
A1	0.03		0.23
b	0.70		0.93
b2	1.14		1.70
c	0.45		0.60
c2	1.23		1.36
D	8.95		9.35
D1	7.50	7.75	8.00
D2	1.10	1.30	1.50
E	10		10.40
E1	8.50	8.70	8.90
E2	6.85	7.05	7.25
e		2.54	
e1	4.88		5.28
H	15		15.85
J1	2.49		2.69
L	2.29		2.79
L1	1.27		1.40
L2	1.30		1.75
R		0.4	
V2	0°		8°

Figure 34: D²PAK (TO-263) recommended footprint (dimensions are in mm)



4.2 D²PAK packing information

Figure 35: Tape outline

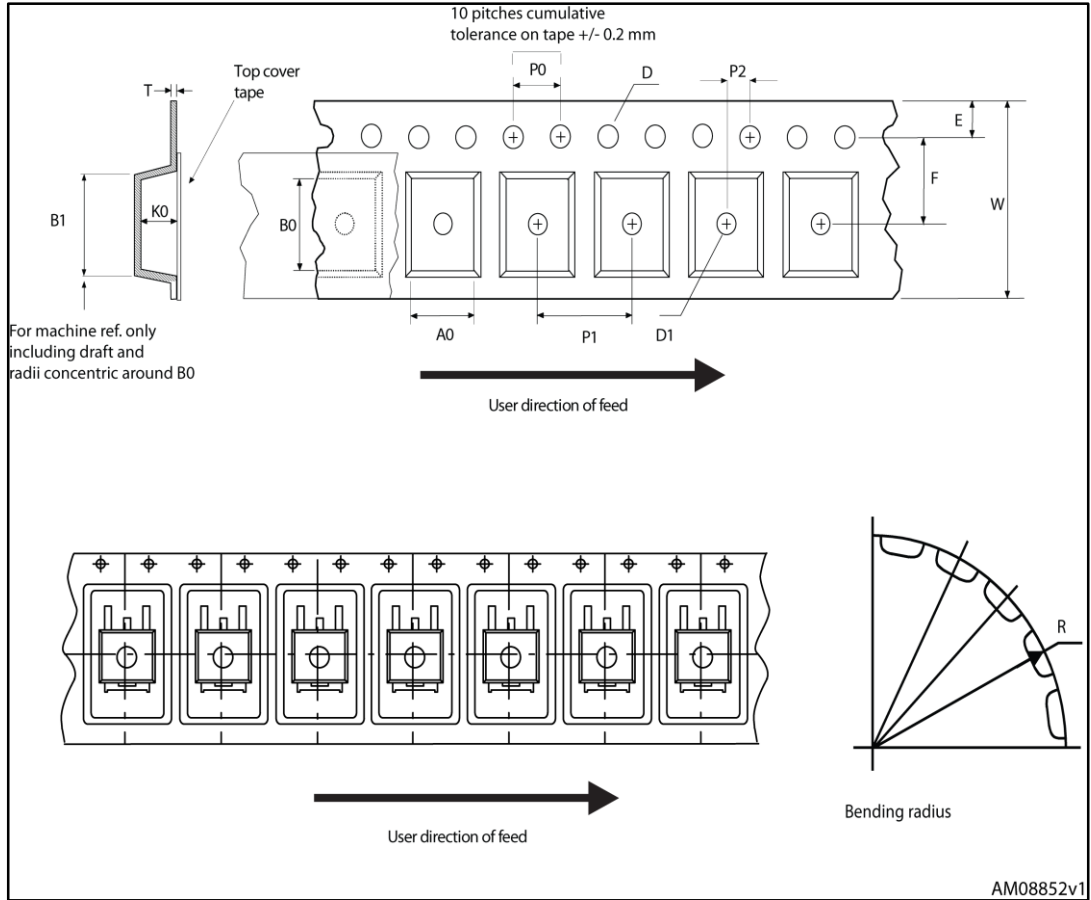

Figure 36: Reel outline

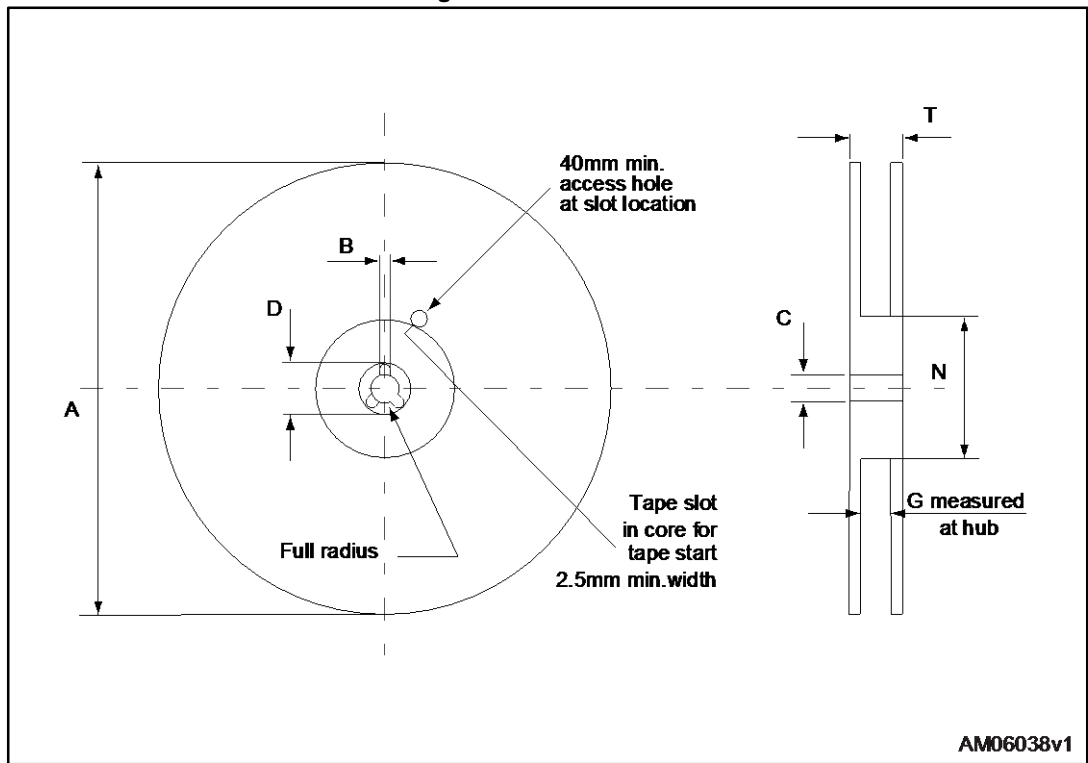

Table 9: D²PAK tape and reel mechanical data

Tape			Reel		
Dim.	mm		Dim.	mm	
	Min.	Max.		Min.	Max.
A0	10.5	10.7	A		330
B0	15.7	15.9	B	1.5	
D	1.5	1.6	C	12.8	13.2
D1	1.59	1.61	D	20.2	
E	1.65	1.85	G	24.4	26.4
F	11.4	11.6	N	100	
K0	4.8	5.0	T		30.4
P0	3.9	4.1			
P1	11.9	12.1	Base quantity		1000
P2	1.9	2.1	Bulk quantity		1000
R	50				
T	0.25	0.35			
W	23.7	24.3			

5 Revision history

Table 10: Document revision history

Date	Revision	Changes
14-Oct-2015	1	First release.
13-Nov-2015	2	Document status promoted from preliminary to production data.

IMPORTANT NOTICE – PLEASE READ CAREFULLY

STMicroelectronics NV and its subsidiaries ("ST") reserve the right to make changes, corrections, enhancements, modifications, and improvements to ST products and/or to this document at any time without notice. Purchasers should obtain the latest relevant information on ST products before placing orders. ST products are sold pursuant to ST's terms and conditions of sale in place at the time of order acknowledgement.

Purchasers are solely responsible for the choice, selection, and use of ST products and ST assumes no liability for application assistance or the design of Purchasers' products.

No license, express or implied, to any intellectual property right is granted by ST herein.

Resale of ST products with provisions different from the information set forth herein shall void any warranty granted by ST for such product.

ST and the ST logo are trademarks of ST. All other product or service names are the property of their respective owners.

Information in this document supersedes and replaces information previously supplied in any prior versions of this document.

© 2015 STMicroelectronics – All rights reserved

Mouser Electronics

Authorized Distributor

Click to View Pricing, Inventory, Delivery & Lifecycle Information:

[STMicroelectronics:](#)

[STGB15M65DF2](#)