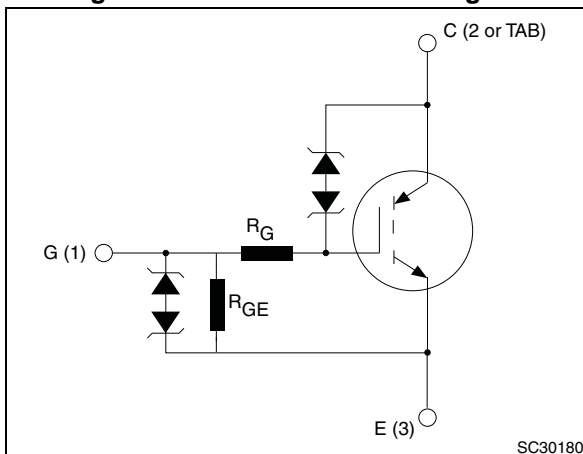

Figure 1. Internal schematic diagram



Features

- Designed for automotive applications and AEC-Q101 qualified
- ESD gate-emitter protection
- Gate-collector high voltage clamping
- Logic level gate drive
- Low saturation voltage
- High pulsed current capability
- Gate and gate-emitter resistor

Applications

- Pencil coil electronic ignition driver

Description

This application-specific IGBT utilizes the most advanced PowerMESH™ technology. The built-in Zener diodes between gate-collector and gate-emitter provide overvoltage protection capabilities. The device also exhibits low on-state voltage drop and low threshold drive for use in automotive ignition systems.

Table 1. Device summary

Order codes	Marking	Packages	Packaging
STGB20N40LZ	GB20N40LZ	D ² PAK	Tape and reel
STGD20N40LZ	GD20N40LZ	DPAK	Tape and reel

Contents

1	Electrical ratings	3
2	Electrical characteristics	4
2.1	Electrical characteristics (curves)	6
3	Test circuits	9
4	Package mechanical data	10
5	Packaging mechanical data	16
6	Revision history	19

1 Electrical ratings

Table 2. Absolute maximum ratings

Symbol	Parameter	Value		Unit
		DPAK	D ² PAK	
V _{CES}	Collector-emitter voltage (V _{GE} = 0)	V _{CES(clamped)}		V
V _{ECS}	Emitter collector voltage (V _{GE} = 0)	20		V
I _C	Collector current (continuous) at T _C = 100 °C	25		A
I _{CP} ⁽¹⁾	Pulsed collector current	40		A
V _{GE}	Gate-emitter voltage	V _{GE(clamped)}		V
P _{TOT}	Total dissipation at T _C = 25 °C	125	150	W
E _{SCIS}	Single pulse energy T _C = 25 °C, L = 3 mH, V _{CC} = 50 V	300		mJ
E _{SCIS}	Single pulse energy T _C = 150 °C, L = 3 mH, V _{CC} = 50 V	180		mJ
ESD	Human body model, R = 1.5 kΩ, C = 100 pF	8		kV
	Machine model, R = 0, C = 100 pF	600		V
	Charged device model	4		kV
T _{stg}	Storage temperature	- 55 to 175		°C
T _J	Operating junction temperature			

1. Pulse width limited by maximum junction temperature.

Table 3. Thermal data

Symbol	Parameter	Value		Unit
		DPAK	D ² PAK	
R _{thj-case}	Thermal resistance junction-case	1.2	1	°C/W
R _{thj-amb}	Thermal resistance junction-ambient	100	62.5	°C/W

2 Electrical characteristics

$T_J = 25\text{ °C}$ unless otherwise specified.

Table 4. Static electrical characteristics

Symbol	Parameter	Test conditions	Min.	Typ.	Max.	Unit
$V_{CES(\text{clamped})}$	Collector emitter clamped voltage ($V_{GE} = 0$)	$I_C = 2\text{ mA}$		390		V
		$I_C = 2\text{ mA}$, $T_J = -40\text{ °C}$ to 175 °C	365		425	V
V_{ECS}	Emitter collector break-down voltage ($V_{GE} = 0$)	$I_C = 75\text{ mA}$		28		V
		$I_C = 75\text{ mA}$ $T_J = -40\text{ °C}$ to 175 °C	20			V
$V_{GE(\text{clamped})}$	Gate emitter clamped voltage	$I_G = \pm 2\text{ mA}$ $T_J = -40\text{ °C}$ to 175 °C	12		16	V
I_{CES}	Collector cut-off current ($V_{GE} = 0$)	$V_{CE} = 15\text{ V}$, $T_J = 175\text{ °C}$			20	μA
		$V_{CE} = 200\text{ V}$, $T_J = 175\text{ °C}$			100	μA
I_{GES}	Gate-emitter leakage current ($V_{CE} = 0$)	$V_{GE} = \pm 10\text{ V}$		625		μA
		$V_{GE} = \pm 10\text{ V}$ $T_J = -40\text{ °C}$ to 175 °C	450		900	μA
R_{GE}	Gate emitter resistance		11	16	22	$\text{k}\Omega$
R_G	Gate resistance			100		Ω
$V_{GE(\text{th})}$	Gate threshold voltage	$V_{GE} = V_{CE}$, $I_C = 1\text{ mA}$	1.5	1.95	2.5	V
		$V_{GE} = V_{CE}$, $I_C = 1\text{ mA}$, $T_J = 175\text{ °C}$	0.85	1.3	1.7	V
$V_{CE(\text{sat})}$	Collector emitter saturation voltage	$V_{GE} = 4.5\text{ V}$, $I_C = 10\text{ A}$, $T_J = 175\text{ °C}$		1.5	1.8	V
		$V_{GE} = 4\text{ V}$, $I_C = 6\text{ A}$,		1.30	1.6	V
g_{fe}	Forward transconductance	$V_{CE} = 25\text{ V}$, $I_C = 10\text{ A}$		10.3		S

Table 5. Dynamic electrical characteristics

Symbol	Parameter	Test conditions	Min.	Typ.	Max.	Unit
C_{ies}	Input capacitance	$V_{CE} = 25\text{ V}$, $f = 1\text{ MHz}$, $V_{GE} = 0$	-	910	-	pF
C_{oes}	Output capacitance		-	70	-	pF
C_{res}	Reverse transfer capacitance		-	10	-	pF
Q_g	Gate charge	$V_{CE} = 280\text{ V}$, $I_C = 10\text{ A}$, $V_{GE} = 5\text{ V}$	-	24	-	nC

Table 6. Switching on/off

Symbol	Parameter	Test conditions	Min.	Typ.	Max.	Unit
$t_{d(on)}$ t_r	Resistive load Turn-on delay time Rise time	$V_{CC} = 14\text{ V}$, $R_g = 1\text{ k}\Omega$, $R_L = 1\ \Omega$, $V_{GE} = 5\text{ V}$	-	0.7 4	-	μs μs
$t_{d(on)}$ t_r	Resistive load Turn-on delay time Rise time	$V_{CC} = 14\text{ V}$, $R_g = 1\text{ k}\Omega$, $R_L = 1\ \Omega$, $V_{GE} = 5\text{ V}$, $T_J = 150\text{ }^\circ\text{C}$	-	0.7 4.5	-	μs μs
$t_{d(off)}$ t_f dv/dt	Inductive load Turn-off delay time Fall time Turn-off voltage slope	$V_{CC} = 300\text{ V}$, $L = 1\text{ mH}$ $I_C = 10\text{ A}$, $V_{GE} = 5\text{ V}$, $R_g = 1\text{ k}\Omega$,	-	4.3 1.5 165	-	μs μs V/ μs
$t_{d(off)}$ t_f dv/dt	Inductive load Turn-off delay time Fall time Turn-off voltage slope	$V_{CC} = 300\text{ V}$, $L = 1\text{ mH}$ $I_C = 10\text{ A}$, $V_{GE} = 5\text{ V}$, $R_g = 1\text{ k}\Omega$, $T_J = 150\text{ }^\circ\text{C}$	-	4.7 3.5 115	-	μs μs V/ μs

2.1 Electrical characteristics (curves)

Figure 2. Collector-emitter on voltage vs temperature ($V_{ge} = 4.5\text{ V}$)

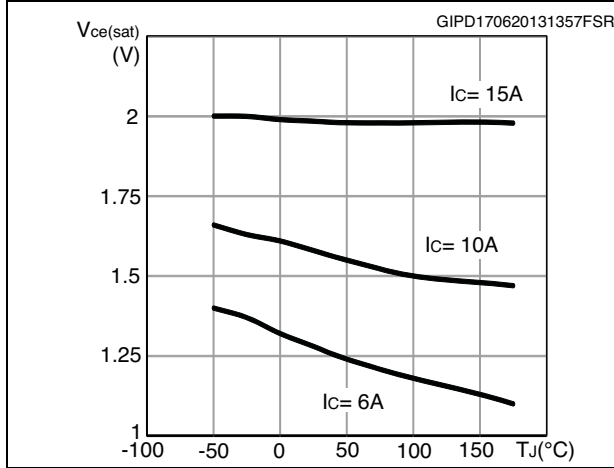

Figure 3. Collector-emitter on voltage vs temperature ($I_c = 6\text{ A}$)

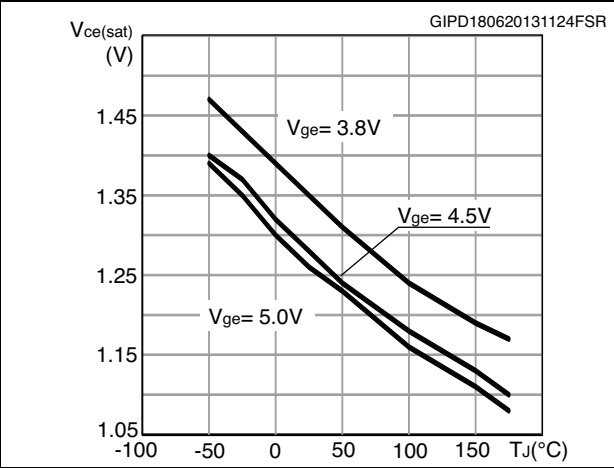

Figure 4. Collector-emitter on voltage vs temperature ($I_c = 10\text{ A}$)

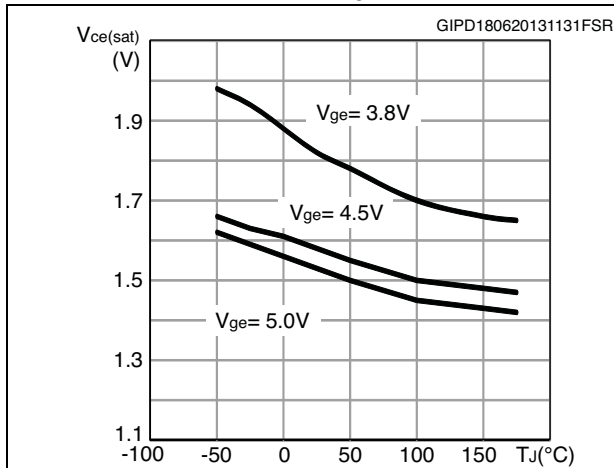

Figure 5. Self clamped inductive switch

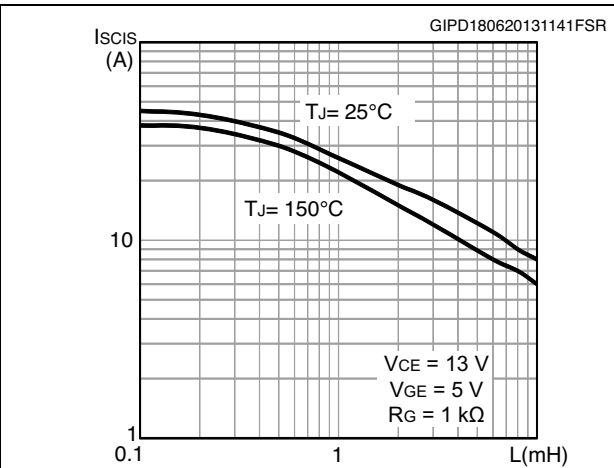

Figure 6. Output characteristics ($T_J = 25\text{ }^\circ\text{C}$)

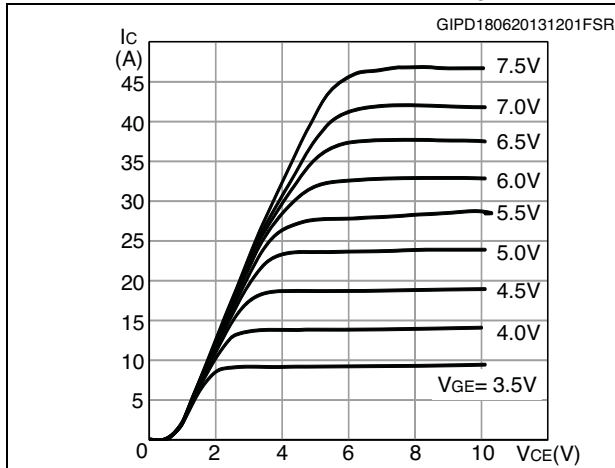

Figure 7. Output characteristics ($T_J = -40\text{ }^\circ\text{C}$)

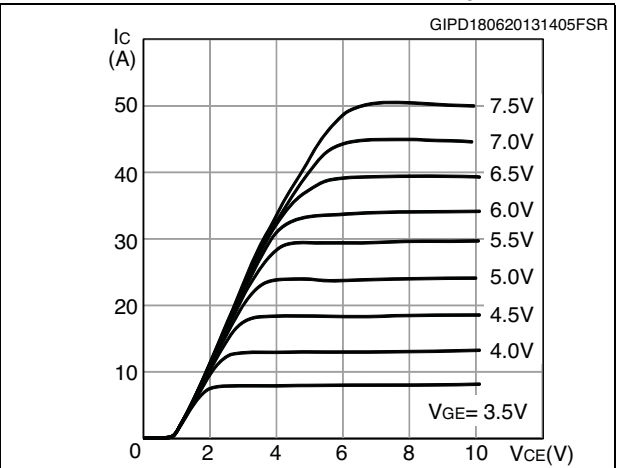

Figure 8. Output characteristics ($T_J = 175\text{ }^\circ\text{C}$)

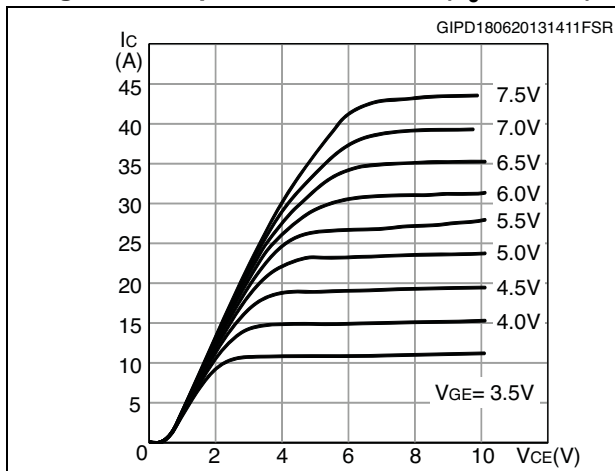

Figure 9. Transfer characteristics

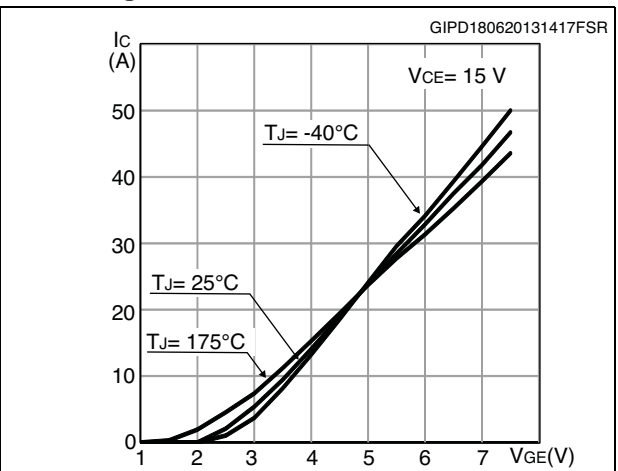

Figure 10. Collector cut-off current vs. temperature

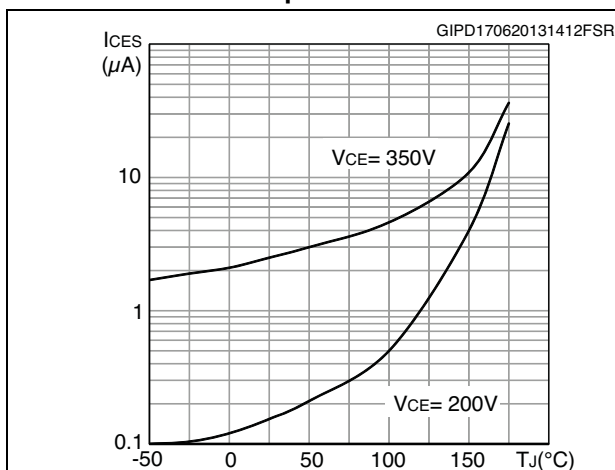

Figure 11. Normalized collector emitter voltage vs temperature

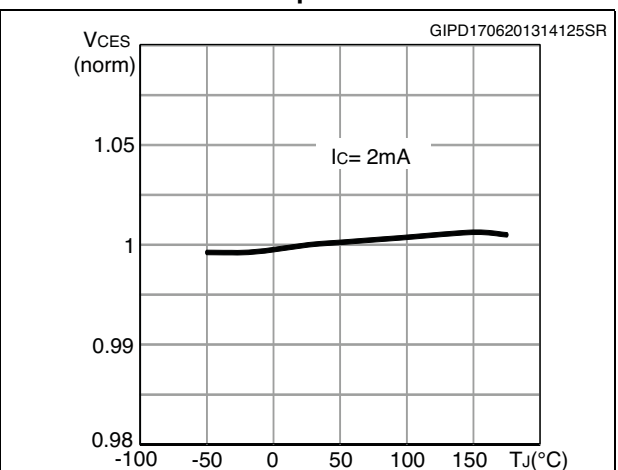

Figure 12. Normalized gate threshold voltage vs temperature

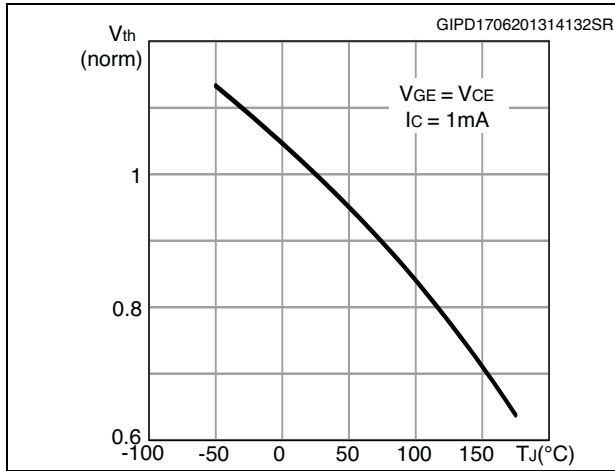

Figure 13. Normalized collector emitter on-voltage vs temperature

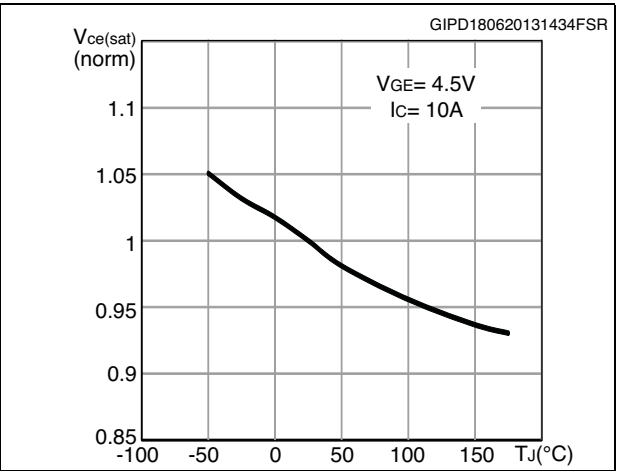

Figure 14. Thermal impedance for D²PAK

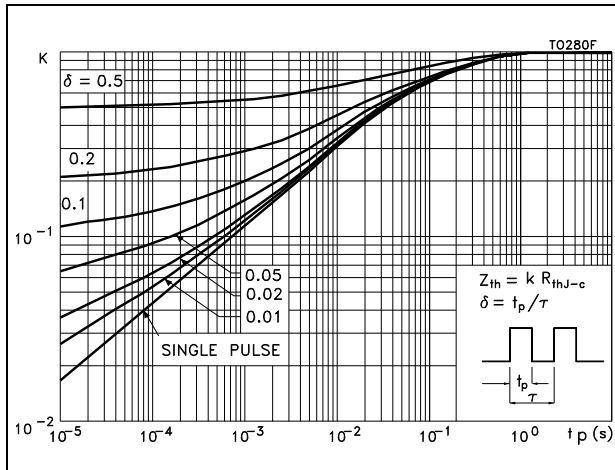
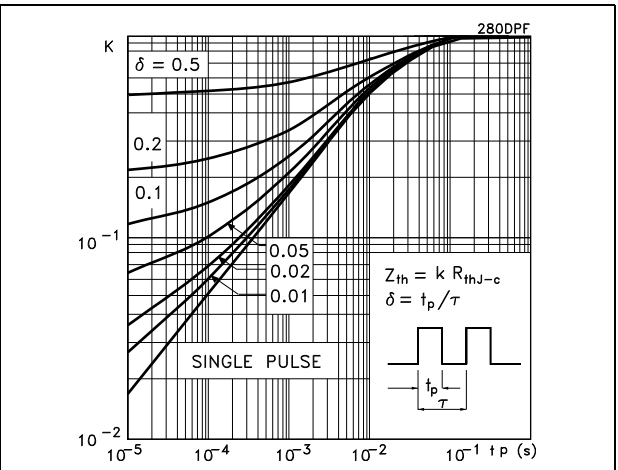

Figure 15. Thermal impedance for DPAK



4 Package mechanical data

In order to meet environmental requirements, ST offers these devices in different grades of ECOPACK® packages, depending on their level of environmental compliance. ECOPACK® specifications, grade definitions and product status are available at: www.st.com. ECOPACK® is an ST trademark.

Figure 20. D²PAK (TO-263) drawing

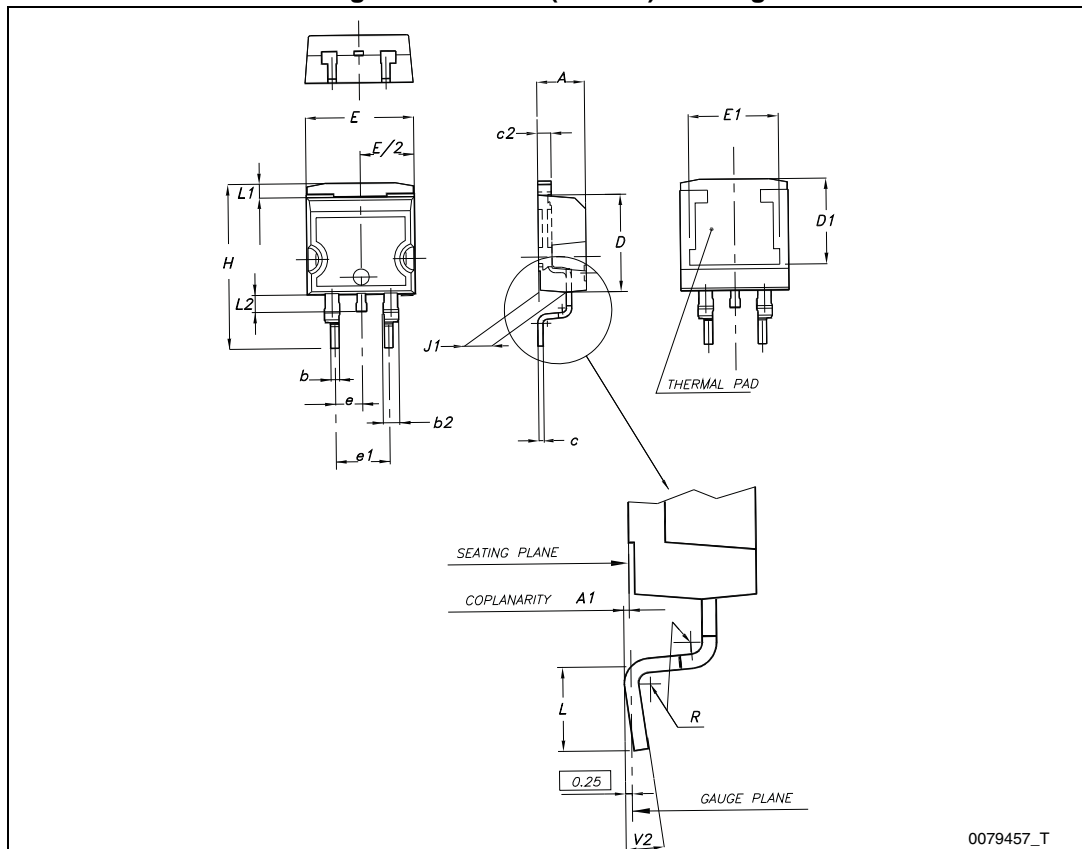
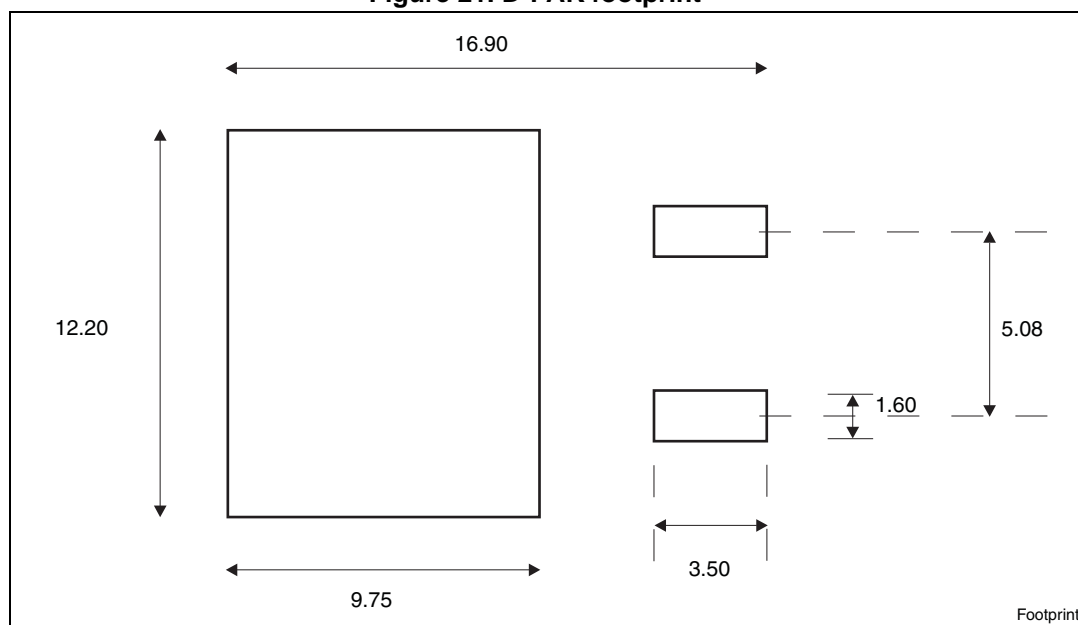

Table 7. D²PAK (TO-263) mechanical data

Dim.	mm		
	Min.	Typ.	Max.
A	4.40		4.60
A1	0.03		0.23
b	0.70		0.93
b2	1.14		1.70
c	0.45		0.60
c2	1.23		1.36
D	8.95		9.35
D1	7.50		
E	10		10.40
E1	8.50		
e		2.54	
e1	4.88		5.28
H	15		15.85
J1	2.49		2.69
L	2.29		2.79
L1	1.27		1.40
L2	1.30		1.75
R		0.4	
V2	0°		8°

Figure 21. D²PAK footprint^(a)



a. All dimension are in millimeters

Figure 22. DPAK (TO-252) type A drawing

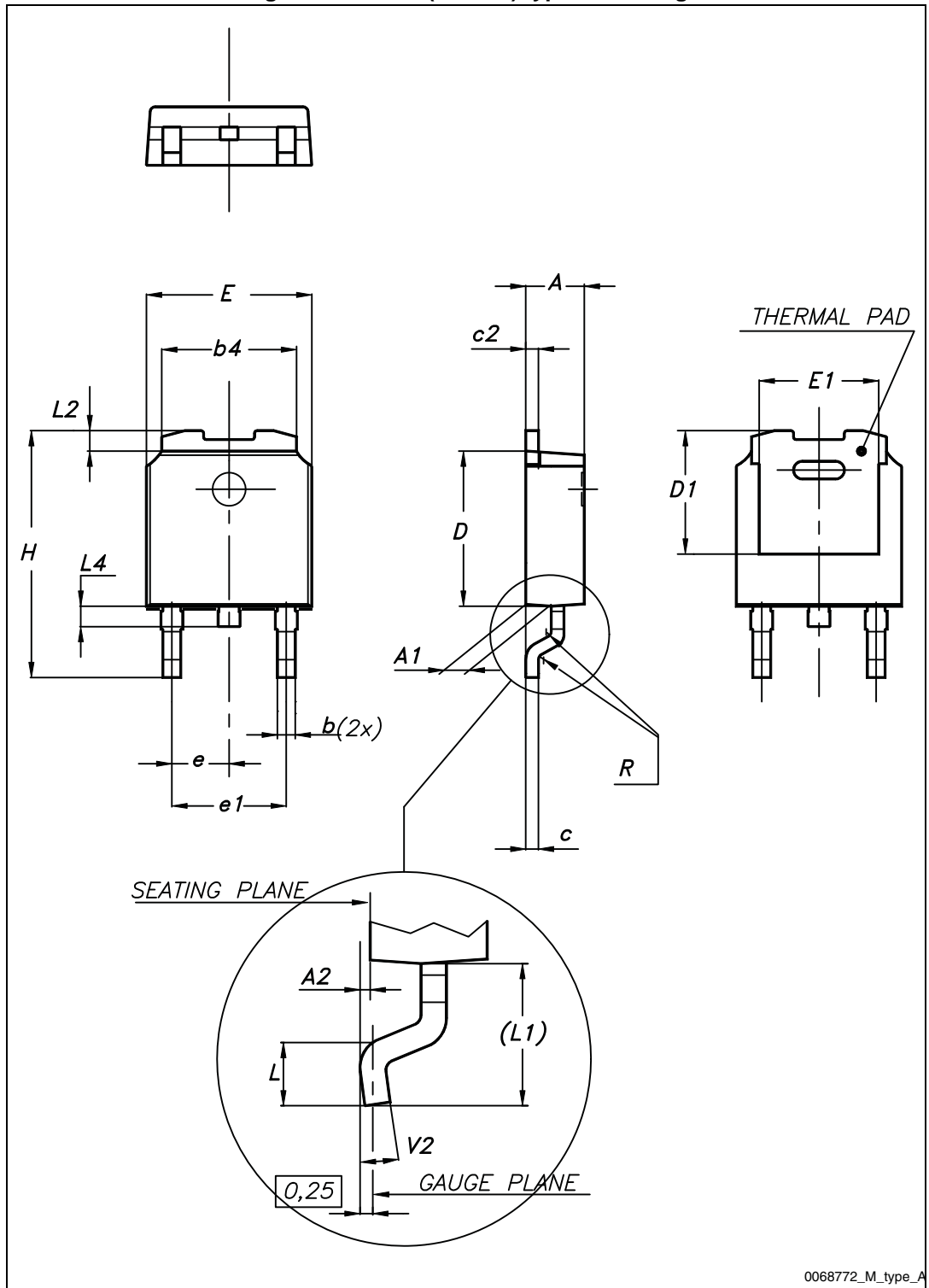
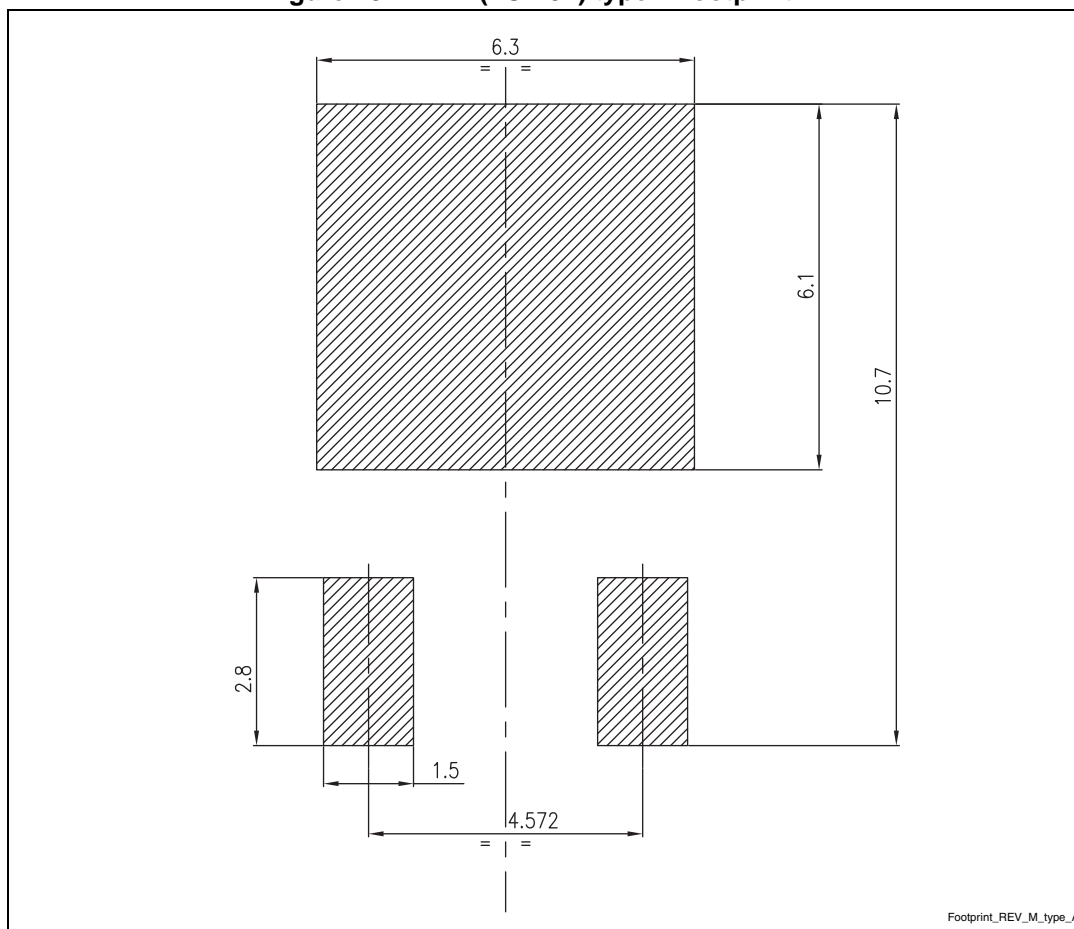

Table 8. DPAK (TO-252) type A mechanical data

Dim.	mm		
	Min.	Typ.	Max.
A	2.20		2.40
A1	0.90		1.10
A2	0.03		0.23
b	0.64		0.90
b4	5.20		5.40
c	0.45		0.60
c2	0.48		0.60
D	6.00		6.20
D1		5.10	
E	6.40		6.60
E1		4.70	
e		2.28	
e1	4.40		4.60
H	9.35		10.10
L	1.00		1.50
(L1)		2.80	
L2		0.80	
L4	0.60		1.00
R		0.20	
V2	0°		8°

Figure 23. DPAK (TO-252) type A footprint (b)



b. All dimensions are in millimeters

5 Packaging mechanical data

Figure 24. Tape drawing

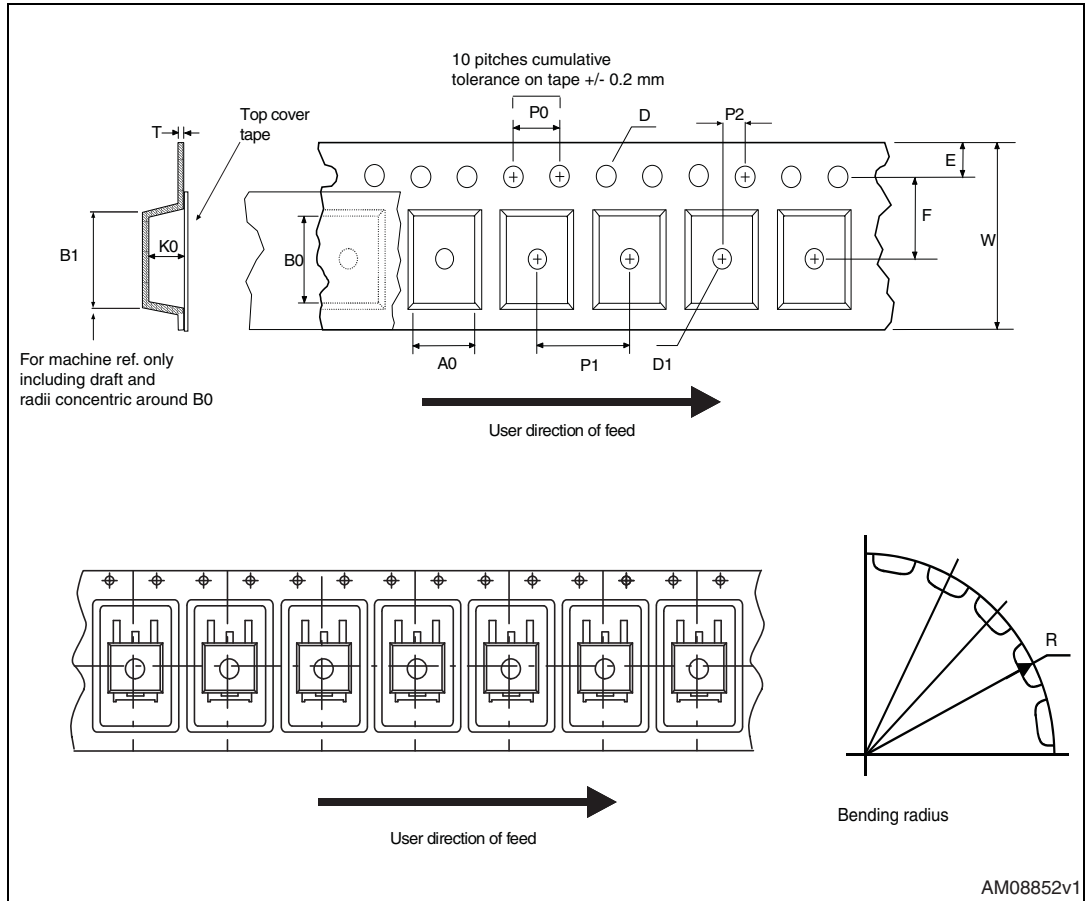

AM08852v1

Figure 25. Reel drawing

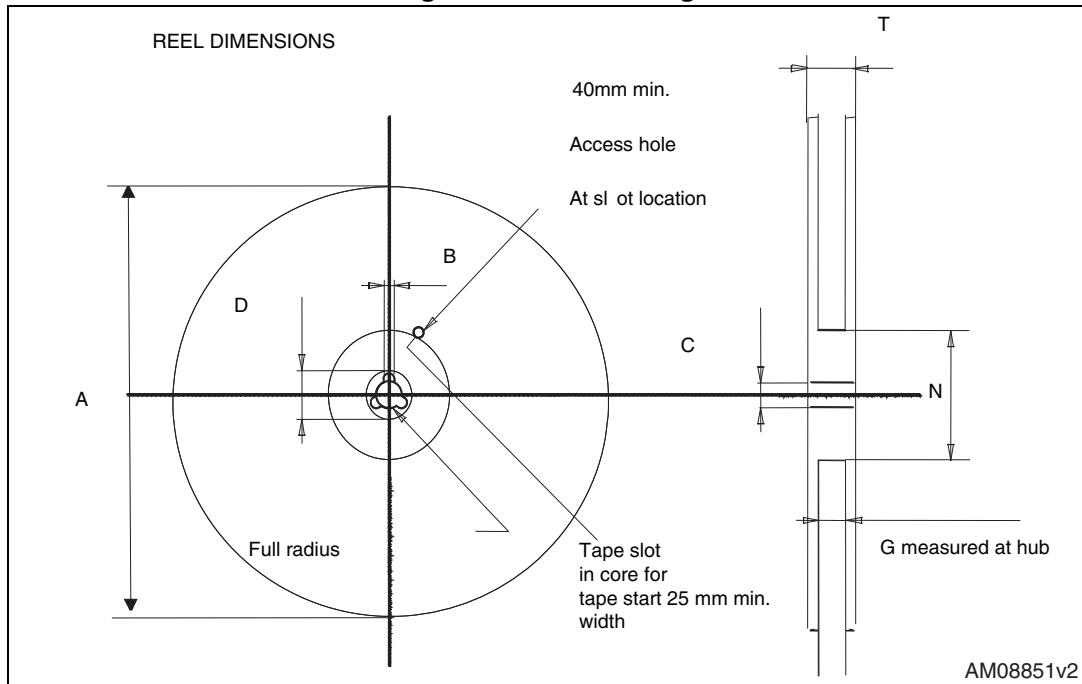

AM08851v2

Table 9. D²PAK (TO-263) tape and reel mechanical data

Tape			Reel		
Dim.	mm		Dim.	mm	
	Min.	Max.		Min.	Max.
A0	10.5	10.7	A		330
B0	15.7	15.9	B	1.5	
D	1.5	1.6	C	12.8	13.2
D1	1.59	1.61	D	20.2	
E	1.65	1.85	G	24.4	26.4
F	11.4	11.6	N	100	
K0	4.8	5.0	T		30.4
P0	3.9	4.1			
P1	11.9	12.1	Base qty		1000
P2	1.9	2.1	Bulk qty		1000
R	50				
T	0.25	0.35			
W	23.7	24.3			

Table 10. DPAK (TO-252) tape and reel mechanical data

Tape			Reel		
Dim.	mm		Dim.	mm	
	Min.	Max.		Min.	Max.
A0	6.8	7	A		330
B0	10.4	10.6	B	1.5	
B1		12.1	C	12.8	13.2
D	1.5	1.6	D	20.2	
D1	1.5		G	16.4	18.4
E	1.65	1.85	N	50	
F	7.4	7.6	T		22.4
K0	2.55	2.75			
P0	3.9	4.1	Base qty.		2500
P1	7.9	8.1	Bulk qty.		2500
P2	1.9	2.1			
R	40				
T	0.25	0.35			
W	15.7	16.3			

6 Revision history

Table 11. Document revision history

Date	Revision	Changes
08-Feb-2013	1	Initial release.
24-Jun-2013	2	Added device in D ² PAK. Modified Table 1: Device summary . Added Section 2.1: Electrical characteristics (curves) . Updated Section 4: Package mechanical data and Section 5: Packaging mechanical data . Minor text changes.
25-Sep-2013	3	Updated $t_{d(on)}$ value for resistive load in Table 6: Switching on/off . Updated mechanical data for DPAK. Minor text changes.
14-Jan-2014	4	Modified title in cover page. Added: E_{SCIS} in Table 2 , V_{ECS} and g_{fs} values in Table 4 . Modified minimum value of $V_{GE(clamped)}$ in Table 4 Updated Section 4: Package mechanical data Modified order codes in Table 1 . Minor text changes.
4-Jun-2014	5	Updated features in cover page.

Please Read Carefully:

Information in this document is provided solely in connection with ST products. STMicroelectronics NV and its subsidiaries ("ST") reserve the right to make changes, corrections, modifications or improvements, to this document, and the products and services described herein at any time, without notice.

All ST products are sold pursuant to ST's terms and conditions of sale.

Purchasers are solely responsible for the choice, selection and use of the ST products and services described herein, and ST assumes no liability whatsoever relating to the choice, selection or use of the ST products and services described herein.

No license, express or implied, by estoppel or otherwise, to any intellectual property rights is granted under this document. If any part of this document refers to any third party products or services it shall not be deemed a license grant by ST for the use of such third party products or services, or any intellectual property contained therein or considered as a warranty covering the use in any manner whatsoever of such third party products or services or any intellectual property contained therein.

UNLESS OTHERWISE SET FORTH IN ST'S TERMS AND CONDITIONS OF SALE ST DISCLAIMS ANY EXPRESS OR IMPLIED WARRANTY WITH RESPECT TO THE USE AND/OR SALE OF ST PRODUCTS INCLUDING WITHOUT LIMITATION IMPLIED WARRANTIES OF MERCHANTABILITY, FITNESS FOR A PARTICULAR PURPOSE (AND THEIR EQUIVALENTS UNDER THE LAWS OF ANY JURISDICTION), OR INFRINGEMENT OF ANY PATENT, COPYRIGHT OR OTHER INTELLECTUAL PROPERTY RIGHT.

ST PRODUCTS ARE NOT DESIGNED OR AUTHORIZED FOR USE IN: (A) SAFETY CRITICAL APPLICATIONS SUCH AS LIFE SUPPORTING, ACTIVE IMPLANTED DEVICES OR SYSTEMS WITH PRODUCT FUNCTIONAL SAFETY REQUIREMENTS; (B) AERONAUTIC APPLICATIONS; (C) AUTOMOTIVE APPLICATIONS OR ENVIRONMENTS, AND/OR (D) AEROSPACE APPLICATIONS OR ENVIRONMENTS. WHERE ST PRODUCTS ARE NOT DESIGNED FOR SUCH USE, THE PURCHASER SHALL USE PRODUCTS AT PURCHASER'S SOLE RISK, EVEN IF ST HAS BEEN INFORMED IN WRITING OF SUCH USAGE, UNLESS A PRODUCT IS EXPRESSLY DESIGNATED BY ST AS BEING INTENDED FOR "AUTOMOTIVE, AUTOMOTIVE SAFETY OR MEDICAL" INDUSTRY DOMAINS ACCORDING TO ST PRODUCT DESIGN SPECIFICATIONS. PRODUCTS FORMALLY ESCC, QML OR JAN QUALIFIED ARE DEEMED SUITABLE FOR USE IN AEROSPACE BY THE CORRESPONDING GOVERNMENTAL AGENCY.

Resale of ST products with provisions different from the statements and/or technical features set forth in this document shall immediately void any warranty granted by ST for the ST product or service described herein and shall not create or extend in any manner whatsoever, any liability of ST.

ST and the ST logo are trademarks or registered trademarks of ST in various countries.

Information in this document supersedes and replaces all information previously supplied.

The ST logo is a registered trademark of STMicroelectronics. All other names are the property of their respective owners.

© 2014 STMicroelectronics - All rights reserved

STMicroelectronics group of companies

Australia - Belgium - Brazil - Canada - China - Czech Republic - Finland - France - Germany - Hong Kong - India - Israel - Italy - Japan - Malaysia - Malta - Morocco - Philippines - Singapore - Spain - Sweden - Switzerland - United Kingdom - United States of America

www.st.com

Mouser Electronics

Authorized Distributor

Click to View Pricing, Inventory, Delivery & Lifecycle Information:

[STMicroelectronics:](#)

[STGD20N40LZ](#) [STGB20N40LZ](#)