



STV300NH02L

N-channel 24 V, 0.8 mΩ typ., 200 A STripFET™ III Power MOSFET in a PowerSO-10 package

Datasheet — production data

Features

Order code	V _{DSS}	R _{DS(on)} max	I _D
STV300NH02L	24 V	0.001 Ω	200 A ⁽¹⁾

1. This value is limited by package

- R_{DS(on)}*Q_g industry's benchmark
- Conduction losses reduced
- Low profile, very low parasitic inductance
- Switching losses reduced

Applications

- Switching applications
 - OR-ing
- Specially designed and optimized for high efficiency DC/DC converters.

Description

This N-channel enhancement mode Power MOSFET benefits from the latest refinement of STMicroelectronics' unique "single feature size" strip-based process, which decreases the critical alignment steps to offer exceptional manufacturing reproducibility. The result is a transistor with extremely high packing density for low on-resistance, rugged avalanche characteristics and low gate charge.

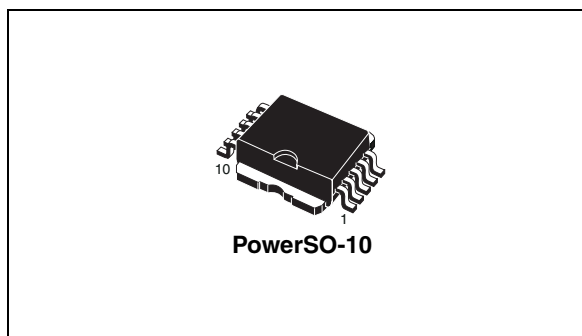

Figure 1. Internal schematic diagram

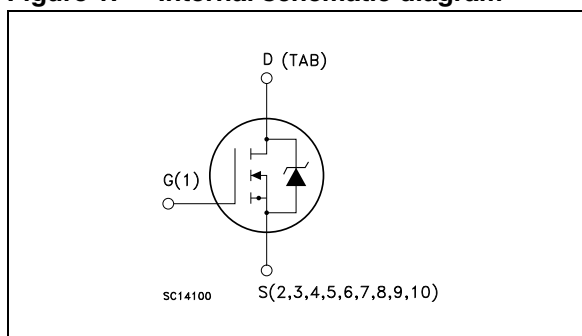

Figure 2. Connection diagram (top view)

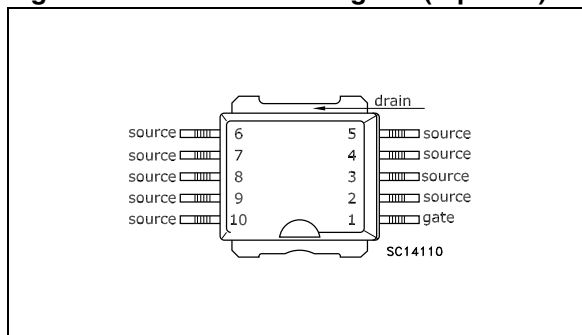

Table 1. Device summary

Order code	Marking	Package	Packaging
STV300NH02L	300NH02L	PowerSO-10	Tape and reel

Content

1	Electrical ratings	3
2	Electrical characteristics	4
	2.1 Electrical characteristics (curves)	6
3	Test circuits	8
4	Package mechanical data	9
5	Packaging mechanical data	11
6	Revision history	13

1 Electrical ratings

Table 2. Absolute maximum ratings

Symbol	Parameter	Value	Unit
V_{DS}	Drain-source voltage	24	V
V_{GS}	Gate-source voltage	± 20	V
$I_D^{(1)}$	Drain current (continuous) at $T_C = 25\text{ }^\circ\text{C}$	200	A
$I_D^{(1)}$	Drain current (continuous) at $T_C = 100\text{ }^\circ\text{C}$	200	A
$I_{DM}^{(2)}$	Drain current (pulsed)	800	A
$P_{TOT}^{(3)}$	Total dissipation at $T_C = 25\text{ }^\circ\text{C}$	300	W
	Derating factor	2	W/ $^\circ\text{C}$
$E_{AS}^{(4)}$	Single pulse avalanche energy	1.6	J
T_{stg}	Storage temperature	-55 to 175	$^\circ\text{C}$
T_j	Operating junction temperature		

1. This value is limited by package
2. Pulse with limited by safe operating area
3. This value is rated according to R_{thj-c}
4. Starting $T_j = 25\text{ }^\circ\text{C}$, $I_D = 60\text{ A}$, $V_{DD} = 20\text{ V}$

Table 3. Thermal data

Symbol	Parameter	Value	Unit
$R_{thj-case}$	Thermal resistance junction-case max	0.5	$^\circ\text{C/W}$
$R_{thj-pcb}^{(1)}$	Thermal resistance junction-pcb max	35	$^\circ\text{C/W}$

1. When mounted on 1 inch² FR-4, 2 oz Cu

2 Electrical characteristics

(T_{case} = 25°C unless otherwise specified)

Table 4. On /off states

Symbol	Parameter	Test conditions	Min.	Typ.	Max.	Unit
V _{(BR)DSS}	Drain-source breakdown voltage (V _{GS} = 0)	I _D = 1 mA	24			V
I _{DSS}	Zero gate voltage drain current (V _{GS} = 0)	V _{DS} = 24 V V _{DS} = 24 V, T _c = 125 °C			1 10	μA μA
I _{GSS}	Gate body leakage current (V _{DS} = 0)	V _{DS} = ± 20 V			±100	nA
V _{GS(th)}	Gate threshold voltage	V _{DS} = V _{GS} , I _D = 250 μA	1	1.5	2.5	V
R _{DS(on)}	Static drain-source on-resistance	V _{GS} = 5 V, I _D = 40 A V _{GS} = 10 V, I _D = 80 A		1.15 0.8	1.5 1	mΩ

Table 5. Dynamic

Symbol	Parameter	Test conditions	Min.	Typ.	Max.	Unit
C _{iss}	Input capacitance	V _{DS} = 15V, f = 1 MHz, V _{GS} = 0	-	7055	-	pF
C _{oss}	Output capacitance			3251		pF
C _{rss}	Reverse transfer capacitance			307		pF
Q _g	Total gate charge	V _{DD} = 12V, I _D = 120A,	-	109	-	nC
Q _{gs}	Gate-source charge	V _{GS} = 10V		30		nC
Q _{gd}	Gate-drain charge	(see Figure 15)		26		nC
R _G	Gate input resistance	V _{DS} = 0V, f = 1 MHz, V _{GS} = 0	-	4.4	-	Ω

Table 6. Switching times

Symbol	Parameter	Test conditions	Min.	Typ.	Max	Unit
t _{d(on)}	Turn-on delay time	V _{DD} = 12V, I _D = 60A R _G = 4.7Ω, V _{GS} = 10V, (see Figure 14)	-	18	-	ns
t _r	Rise time			275		ns
t _{d(off)}	Turn-off delay time	V _{DD} = 12V, I _D = 60A R _G = 4.7Ω, V _{GS} = 10V, (see Figure 14)	-	138	-	ns
t _f	Fall time			94.4		ns

Table 7. Source drain diode

Symbol	Parameter	Test conditions	Min.	Typ.	Max.	Unit
I_{SD}	Source-drain current		-		200	A
I_{SDM}	Source-drain current (pulsed)				800	A
$V_{SD}^{(1)}$	Forward on voltage	$I_{SD} = 120A, V_{GS} = 0$	-		1.3	V
t_{rr}	Reverse recovery time	$I_{SD} = 120A, di/dt = 100A/\mu s$		63		ns
Q_{rr}	Reverse recovery charge	$V_{DD} = 20V, T_j = 25^\circ C$	-	85		nC
I_{RRM}	Reverse recovery current	(see Figure 19)		2.7		A
t_{rr}	Reverse recovery time	$I_{SD} = 120A, di/dt = 100A/\mu s$		63		ns
Q_{rr}	Reverse recovery charge	$V_{DD} = 20V, T_j = 150^\circ C$	-	88		nC
I_{RRM}	Reverse recovery current	(see Figure 19)		2.8		A

1. Pulsed: Pulse duration = 300 μs , duty cycle 1.5%

2.1 Electrical characteristics (curves)

Figure 3. Safe operating area

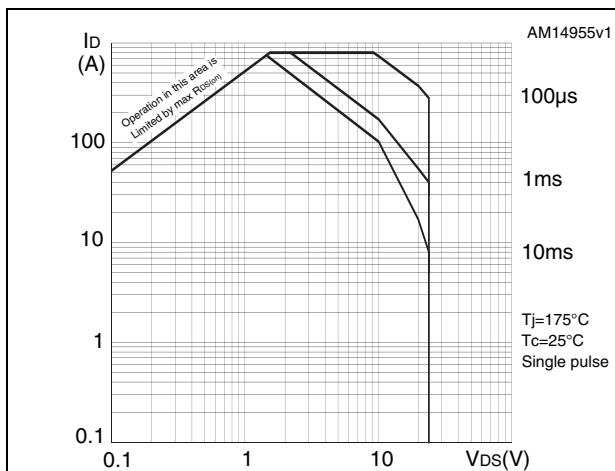

Figure 4. Thermal impedance

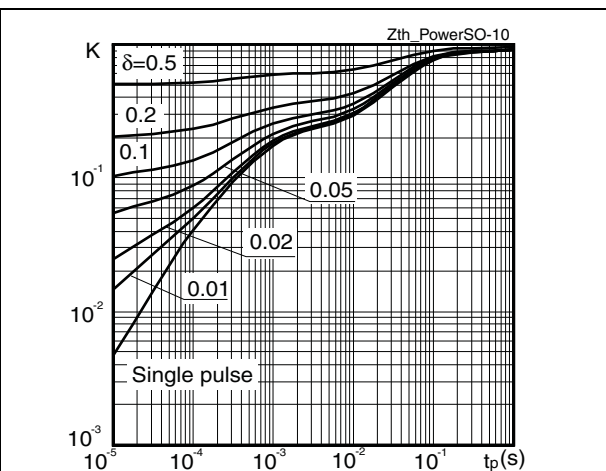

Figure 5. Output characteristics

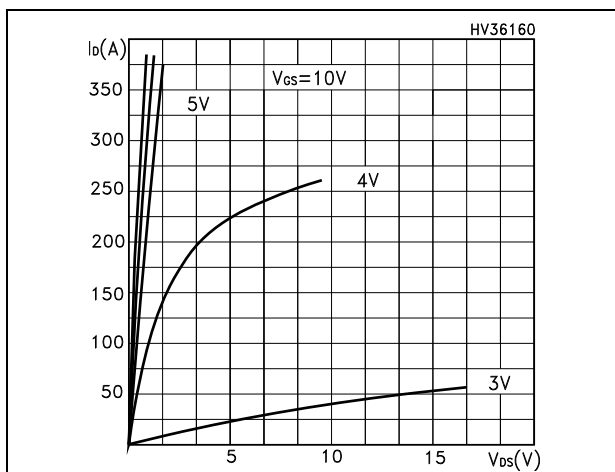

Figure 6. Transfer characteristics

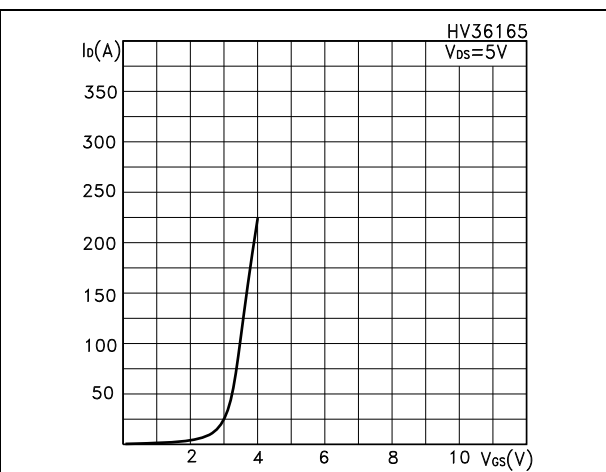

Figure 7. Static drain-source on-resistance

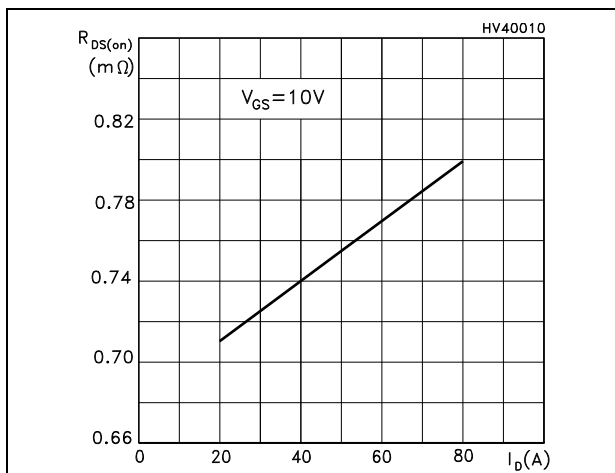

Figure 8. Normalized BV_{DSS} vs temperature

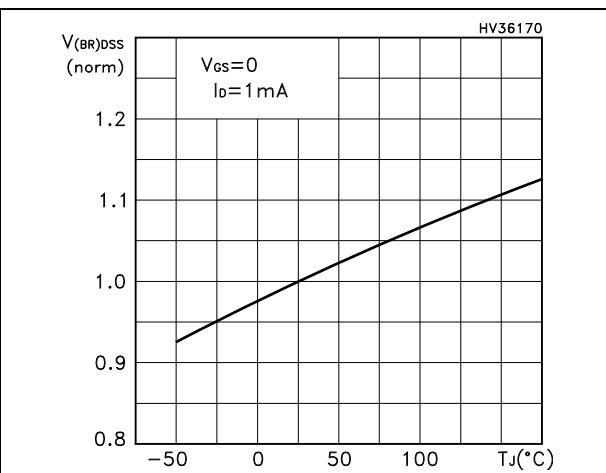

Figure 9. Gate charge vs gate-source voltage Figure 10. Capacitance variations

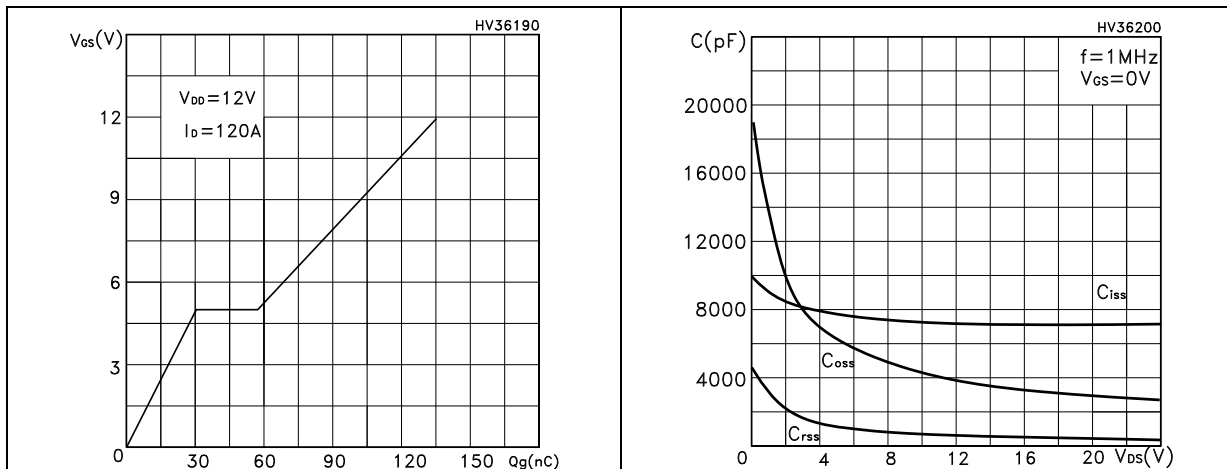

Figure 11. Normalized gate threshold voltage vs temperature Figure 12. Normalized on-resistance vs temperature

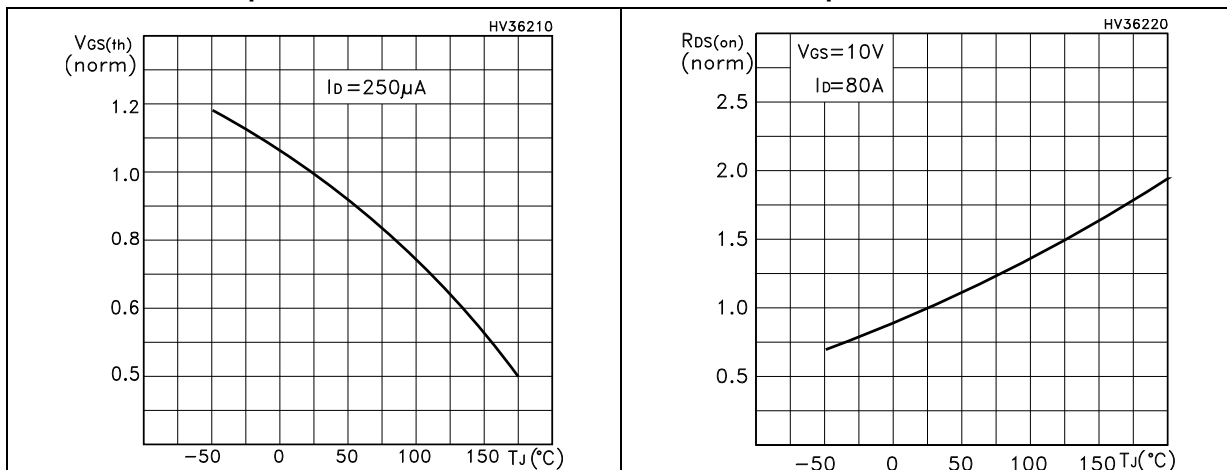
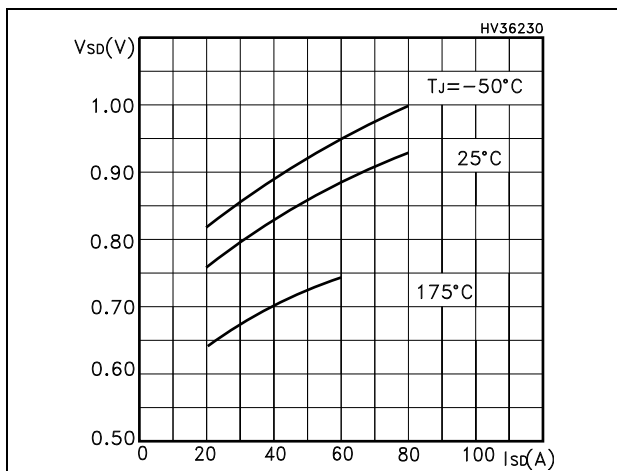

Figure 13. Source-drain diode forward characteristics



3 Test circuits

Figure 14. Switching times test circuit for resistive load



AM01468v1

Figure 15. Gate charge test circuit



AM01469v1

Figure 16. Test circuit for inductive load switching and diode recovery times



AM01470v1

Figure 17. Unclamped inductive load test circuit



AM01471v1

Figure 18. Unclamped inductive waveform

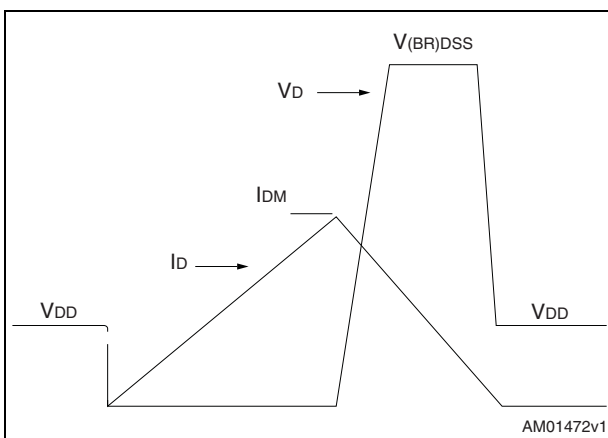

AM01472v1

Figure 19. Switching time waveform

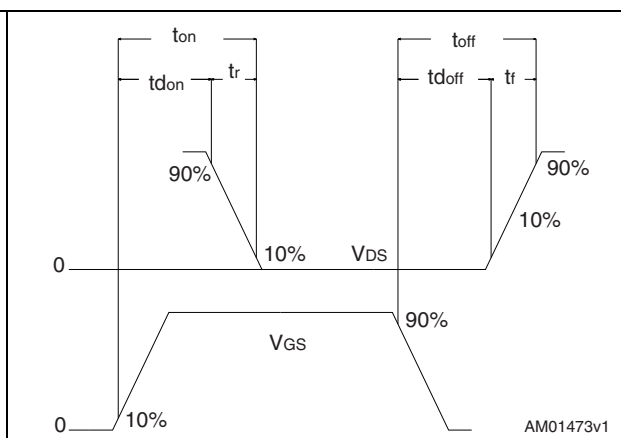

AM01473v1

4 Package mechanical data

In order to meet environmental requirements, ST offers these devices in different grades of ECOPACK[®] packages, depending on their level of environmental compliance. ECOPACK[®] specifications, grade definitions and product status are available at: www.st.com. ECOPACK is an ST trademark.

Table 8. PowerSO-10 mechanical data

Dim.	mm		
	Min.	Typ.	Max.
A			3.70
A1	0.00		0.10
A2	3.40		3.60
A3	1.25		1.35
b	0.40		0.53
c	0.35		0.55
D	9.40		9.60
D1	7.40		7.60
E	13.80		14.40
E1	9.30		9.50
E2	7.20		7.60
E3	5.90		6.10
e		1.27	
L	0.95		1.65
<	0°		8°

Figure 20. PowerSO-10 drawing

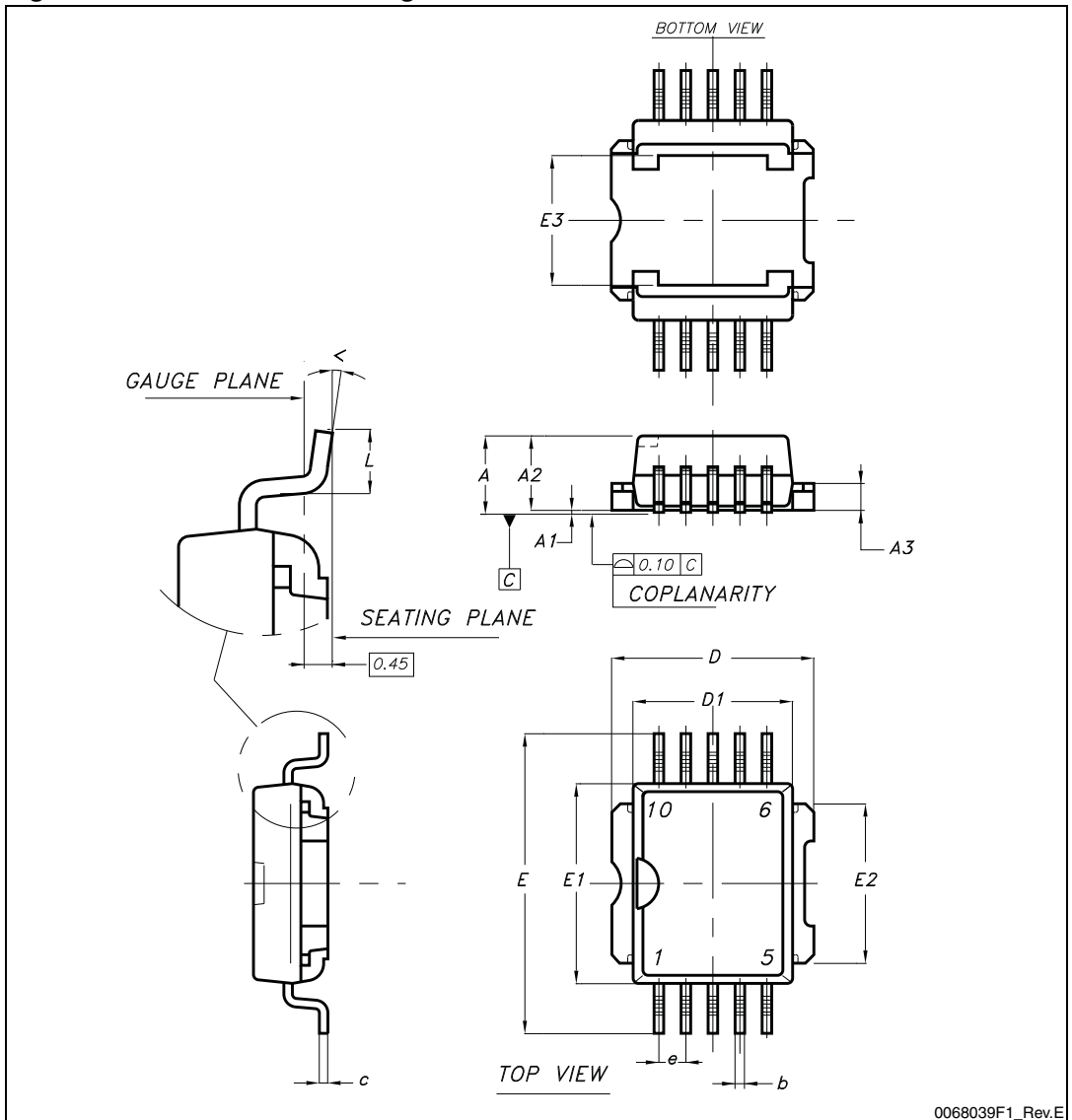

5 Packaging mechanical data

Table 9. Carrier tape dimensions

Ref.	mm		
	Min.	Typ.	Max.
A0	14.9	15.0	15.1
B0	9.9	10.0	10.1
K0	4.15	4.25	4.35
F	11.4	11.5	11.6
E	1.65	1.75	1.85
W	23.7	24.0	24.3
P2	1.9	2.0	2.1
P0	3.9	4.0	4.1
P1	23.9	24.0	24.1
T	0.025	0.30	0.35
D(Ø)	1.50	1.55	1.60

Note: 10 sprocket hole pitch cumulative tolerance ± 0.2 mm.

Figure 21. Carrier tape drawing (a)

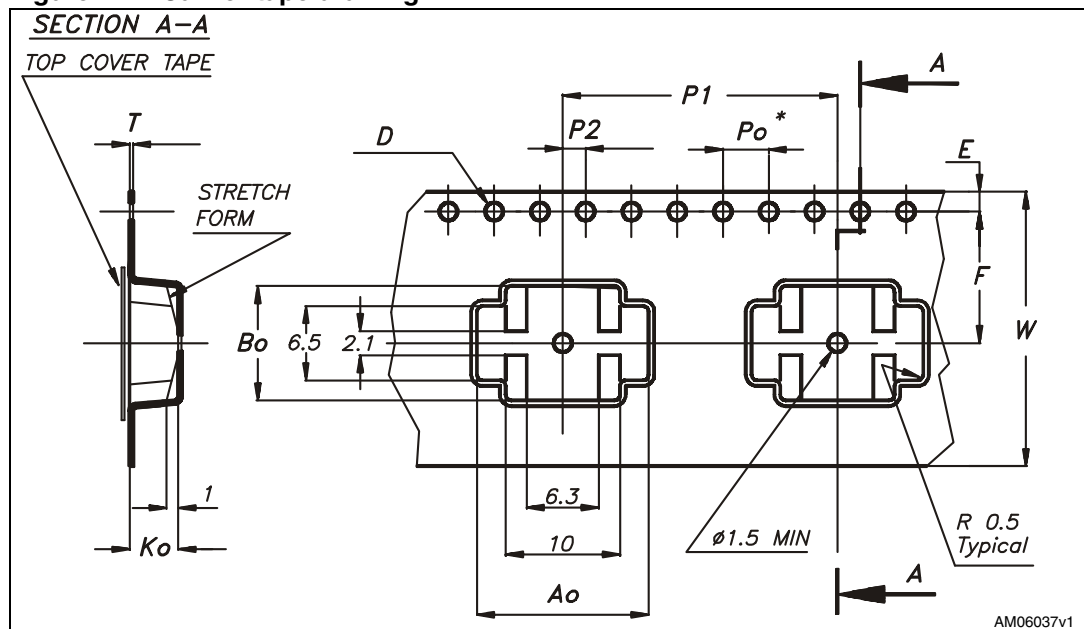

a. Drawing is not to scale.

Table 10. Reel dimensions

Ref.	mm		
	Min.	Typ.	Max.
A			330
B	1.5		
C	12.8	13	13.2
D	20.2		
N	60		
G		24.4	
T			30.4

Note: 10 sprocket hole pitch cumulative tolerance ± 0.2 mm.

Figure 22. Reel drawing (b)

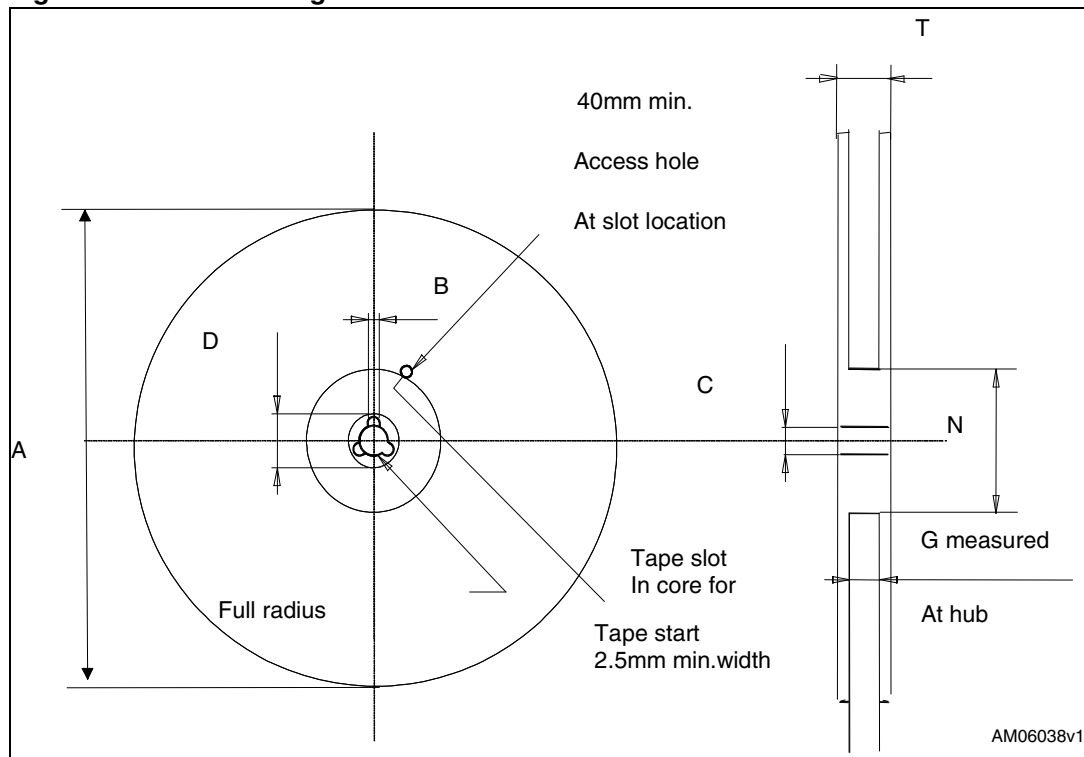

Table 11. Base/bulk quantities

Base qty.	Bulk qty.
	600

b. Drawing is not to scale.

6 Revision history

Table 12. Revision history

Date	Revision	Changes
08-Feb-2007	1	First release
13-Sep-2007	2	New section has been added: 2.1: Electrical characteristics (curves) .
10-Oct-2012	3	Updated Table 4: On /off states and Section 4: Package mechanical data . Inserted Section 5: Packaging mechanical data . Minor text changes.

Please Read Carefully:

Information in this document is provided solely in connection with ST products. STMicroelectronics NV and its subsidiaries ("ST") reserve the right to make changes, corrections, modifications or improvements, to this document, and the products and services described herein at any time, without notice.

All ST products are sold pursuant to ST's terms and conditions of sale.

Purchasers are solely responsible for the choice, selection and use of the ST products and services described herein, and ST assumes no liability whatsoever relating to the choice, selection or use of the ST products and services described herein.

No license, express or implied, by estoppel or otherwise, to any intellectual property rights is granted under this document. If any part of this document refers to any third party products or services it shall not be deemed a license grant by ST for the use of such third party products or services, or any intellectual property contained therein or considered as a warranty covering the use in any manner whatsoever of such third party products or services or any intellectual property contained therein.

UNLESS OTHERWISE SET FORTH IN ST'S TERMS AND CONDITIONS OF SALE ST DISCLAIMS ANY EXPRESS OR IMPLIED WARRANTY WITH RESPECT TO THE USE AND/OR SALE OF ST PRODUCTS INCLUDING WITHOUT LIMITATION IMPLIED WARRANTIES OF MERCHANTABILITY, FITNESS FOR A PARTICULAR PURPOSE (AND THEIR EQUIVALENTS UNDER THE LAWS OF ANY JURISDICTION), OR INFRINGEMENT OF ANY PATENT, COPYRIGHT OR OTHER INTELLECTUAL PROPERTY RIGHT.

UNLESS EXPRESSLY APPROVED IN WRITING BY TWO AUTHORIZED ST REPRESENTATIVES, ST PRODUCTS ARE NOT RECOMMENDED, AUTHORIZED OR WARRANTED FOR USE IN MILITARY, AIR CRAFT, SPACE, LIFE SAVING, OR LIFE SUSTAINING APPLICATIONS, NOR IN PRODUCTS OR SYSTEMS WHERE FAILURE OR MALFUNCTION MAY RESULT IN PERSONAL INJURY, DEATH, OR SEVERE PROPERTY OR ENVIRONMENTAL DAMAGE. ST PRODUCTS WHICH ARE NOT SPECIFIED AS "AUTOMOTIVE GRADE" MAY ONLY BE USED IN AUTOMOTIVE APPLICATIONS AT USER'S OWN RISK.

Resale of ST products with provisions different from the statements and/or technical features set forth in this document shall immediately void any warranty granted by ST for the ST product or service described herein and shall not create or extend in any manner whatsoever, any liability of ST.

ST and the ST logo are trademarks or registered trademarks of ST in various countries.

Information in this document supersedes and replaces all information previously supplied.

The ST logo is a registered trademark of STMicroelectronics. All other names are the property of their respective owners.

© 2012 STMicroelectronics - All rights reserved

STMicroelectronics group of companies

Australia - Belgium - Brazil - Canada - China - Czech Republic - Finland - France - Germany - Hong Kong - India - Israel - Italy - Japan - Malaysia - Malta - Morocco - Philippines - Singapore - Spain - Sweden - Switzerland - United Kingdom - United States of America

www.st.com

Mouser Electronics

Authorized Distributor

Click to View Pricing, Inventory, Delivery & Lifecycle Information:

[STMicroelectronics:](#)

[STV300NH02L](#)